

NuDAQ[®]

ACL-6126

**6-Channel D/A Output
& DIO Card**

User's Guide

@Copyright 1996~2000 ADLINK Technology Co., Ltd.
All Rights Reserved.

Manual Rev.3.35: June 1, 2000

The information in this document is subject to change without prior notice in order to improve reliability, design and function and does not represent a commitment on the part of the manufacturer.

In no event will the manufacturer be liable for direct, indirect, special, incidental, or consequential damages arising out of the use or inability to use the product or documentation, even if advised of the possibility of such damages.

This document contains proprietary information protected by copyright. All rights are reserved. No part of this manual may be reproduced by any mechanical, electronic, or other means in any form without prior written permission of the manufacturer.

Trademarks

NuDAQ is the registered trademark of ADLink Technology Inc.

Other product names mentioned herein are used for identification purposes only and may be trademarks and/or registered trademarks of their respective companies.

Getting service from ADLink

- ◆ **Customer Satisfaction is always the most important thing for ADLink Tech Inc. If you need any help or service, please contact us and get it.**

ADLink Technology Inc.			
Web Site	http://www.adlink.com.tw		
Sales & Service	service@adlink.com.tw		
Technical Support	NuDAQ	nudaq@adlink.com.tw	
	NuDAM	nudam@adlink.com.tw	
	NuIPC	nuipc@adlink.com.tw	
	NuPRO	nuopro@adlink.com.tw	
	Software	sw@adlink.com.tw	
	AMB	amb@adlink.com.tw	
TEl	+886-2-82265877	FAX	+886-2-82265717
Address	9F, No. 166, Jian Yi Road, Chungho City, Taipei, 235 Taiwan, R.O.C.		

- ◆ **Please inform or FAX us of your detailed information for a prompt, satisfactory and constant service.**

Detailed Company Information			
Company/Organization			
Contact Person			
E-mail Address			
Address			
Country			
TEl		FAX	
Web Site			
Questions			
Product Model			
Environment to Use	<input type="checkbox"/> OS: _____ <input type="checkbox"/> Computer Brand : _____ <input type="checkbox"/> M/B : <input type="checkbox"/> CPU : <input type="checkbox"/> Chipset : <input type="checkbox"/> Bios : <input type="checkbox"/> Video Card : <input type="checkbox"/> Network Interface Card : <input type="checkbox"/> Other :		
Challenge Description			
Suggestions for ADLink			

Contents

Chapter 1 Introduction	1
1.1 Features.....	2
1.2 Applications.....	2
1.3 Specifications.....	2
1.4 Software Support.....	5
1.4.1 <i>Programming Library</i>	5
1.4.2 <i>LabView Driver</i>	5
Chapter 2 Installation	6
2.1 What You Have	6
2.2 Unpacking.....	6
2.3 ACL-6126's Layout.....	7
2.4 Jumper and DIP Switch Description	8
2.5 Base Address Setting.....	8
2.6 IRQ Level Setting.....	9
2.7 D/A Output Configuration.....	10
2.8 Connector Pin Assignment.....	13
2.9 Signal Connection	15
2.10 Software Installation.....	17
Chapter 3 Registers Format	18
3.1 I/O Port Address.....	18
3.2 D/A Data Register.....	19
3.3 Digital I/O Register.....	23
3.4 Demonstration Programs.....	23
Product Warranty/Service	25

How to Use This Manual

This manual is written to help you use the ACL-6126. The manual describes how to modify various settings on the ACL-6126 card to meet your requirements. It is divided into three chapters:

- **Chapter 1**, "*Introduction*," gives an overview of the product features, applications and specifications.
- **Chapter 2**, "*Installation*," describes how to install the ACL-6126, including the jumper setting for base address, interrupt IRQ level and D/A output ranges. The layout of ACL-6126 is also shown. Besides, all connectors' pins assignment are also specified.
- **Chapter 3**, "*Programming*," describes how to program the ACL-6126 for analog outputs and digital I/Os.

1

Introduction

The ACL-6126 provides 6-channel analog outputs, 16-channel digital inputs and 16-channel digital outputs add-on card for the IBM Personal Computer and compatible computers. It is designed for industrial control applications requiring analog outputs (voltage and current)with 12-bit resolution in rugged environment.

The ACL-6126 transmits six analog outputs with various user configurable ranges of : 0 ~ +10V, 0 ~ +5V $\pm 10V$, $\pm 5V$, and 4 to 20 mA current loop.

Each D/A has a double-buffered output for single-step update and occupies its own I/O location. Also, a rugged and reliable 37-pin D-sub style connector is provided for analog outputs.

In addition to the 6 analog outputs, the ACL-6126 has 16 digital inputs and 16 digital outputs, all of the digital channels are TTL compatible. The ACLD-9182 (16-bit Isolation digital input board) and ACLD-9185 (16-bit relay output board) are designed for connection with the digital input and output.

We apply the state-of-the-art technology and components when designing ACL-6126. Its compact size PCB board let this card easily fit into any kind of chassis. Also, all the components on the card are SMT type,so it improves the reliability and quality of this card.

1.1 Features

- The ACL-6126 6-channel D/A Output Card provides the following advanced features:
- AT Bus support
- Six multiplying analog output channels
- 12-bit resolution, double buffered D/A converter
- Multiple Output Range : Unipolar : 0 ~ +5 V , 0 ~ +10 V
Bipolar : ± 5 V, ± 10 V
Current Loop : 4 ~ 20mA
- All D/A outputs will be 0V after RESET or POWER-ON
- 16 digital output channels
- 16 digital input channels
- Enhanced IRQ capability from IRQ3 to IRQ15
- Register structure is fully compatible with Advantech's PCL-726

1.2 Applications

- Industrial and laboratory ON/OFF control
- Energy management
- Function generator
- Programmable voltage source
- Security controller
- DIP loop control
- Programmable current sink
- Waveform and pulse generation

1.3 Specifications

- **Analog Output(D/A)**
 - Converter: DAC7541 AJP or equivalent
 - Conversion type : monolithic multiplying

- Number of channels : 6 channels
- Resolution : 12-bit, double buffered output

- Output ranges : Unipolar :0V~+5V or 0~+10V
Bipolar : $\pm 5V$ or $\pm 10V$
4 ~ 20mA current loop (sink)
- Reference Voltage : $\pm 10V$ with external DC or AC
reference; Internal : -5V or -10V
- Current Loop : External : +10V or -10V max.
- Settling time : 70 microsecond max.
- Linearity : $\pm 1/2$ bit
- Accuracy : $\pm 0.012\%$ of full scale range
- Voltage driving capability : $\pm 5mA$ (max.)
- Current Loop exciting voltage : 4 ~ 20 mA (sink) 8V(min.) ,
36V(max.) for current loop
4mA ~ 20mA
- Output initial status : 0V (after RESET or POWER-ON)

➤ **Digital Input (D/I)**

- Channel : 16 channels
- Level : TTL compatible
- Input logic low voltage : Min. -0.5V; Max. 0.8V
- Input logic high voltage : Min. 2.0V; Max. 5.0V
- Input loading current : Max. 0.2 mA at 0.4V
- Input hysteresis : Typical 0.4V; Min. 0.2V

➤ **Digital Output (D/O)**

- Channel : 16 channels
- Level : TTL compatible
- Input logic low voltage(Sink) : Max. 0.5V at 24mA
Max. 0.4V at 12mA
- Input logic high voltage (Source) : Min 2.0V at 15mA
Min. 2.4V at 3mA
- Driving Capacity: All inputs and outputs are TTL/DTL
compatible and outputs will drive
standard TTL load (74 series) or
LSTTL (74LS) loads
- Input hysteresis : Typical 0.4V; Min. 0.2V

➤ **General Specification**

- Bus: PC/AT bus
- I/O connectors : 37-pin D-sub connector (analog output)
20-pin ribbon connector (digital I/O)
- Operating temp: 0°C ~ 55°C
- Storage temp: -20°C ~ 80°C
- Humidity: 5% ~ 95%, non-condensing
- Power Consumption : +5V: 360mA typical
450mA max.
+12V: 60mA typical
180mA max.
-12V: 20mA typical
90mA max.
- Dimension : Half-Size 163 mm x 123 mm

1.4 Software Support

1.4.1 Programming Library

For the customers who are writing their own programs, we provide MS-DOS Borland C/C++ programming library.

ACLS-DLL2 is the Development Kit for NuDAQ ISA-Bus Cards with Analog I/O, windows 3.1/95(98)/NT. ACLS-DLL2 can be used for many programming environments, such as VC++, VB, Delphi. ACLS-DLL2 is included in the ADLINK CD. It need license.

1.4.2 LabView Driver

The ACLS-LVIEW includes the ACL-6126's Vis, which is used to interface with NI's LabView software package. The ACLS-LVIEW supports Windows-95(98)/NT. ACLS-LVIEW is included in the ADLINK CD. It need license.

2

Installation

This chapter describes how to install the ACL-6126. At first, the contents in the package and unpacking information that you should be careful of are described. The jumpers and switches setting for the ACL-6126's base address, IRQ, reference voltage source and DA output mode are also specified.

2.1 What You Have

In addition to this *User's Manual*, the package includes the following items:

- ACL-6126 6-channel Analog Output Card
- ADLINK CD

If any of these items is missing or damaged, contact the dealer from whom you purchased the product. Save the shipping materials and carton in case you want to ship or store the product in the future.

2.2 Unpacking

Your ACL-6126 card contains sensitive electronic components that can be easily damaged by static electricity.

The card should be put on a grounded anti-static mat. The operator should be wearing an anti-static wristband, grounded at the same point as the anti-static mat.

Inspect the card module carton for obvious damage. Shipping and handling may cause damage to your module. Be sure there is no shipping and handling damage on the module before processing.

After opening the card module carton, extract the system module and

place it only on a grounded anti-static surface with components side up.

Again inspect the module for damage. Press down on all the socketed IC's to make sure that they are properly seated. Do this only with the module place on a firm flat surface.

Note : DO NOT APPLY POWER TO THE CARD IF IT HAS BEEN DAMAGED.

You are now ready to install your ACL-6126.

2.3 ACL-6126's Layout

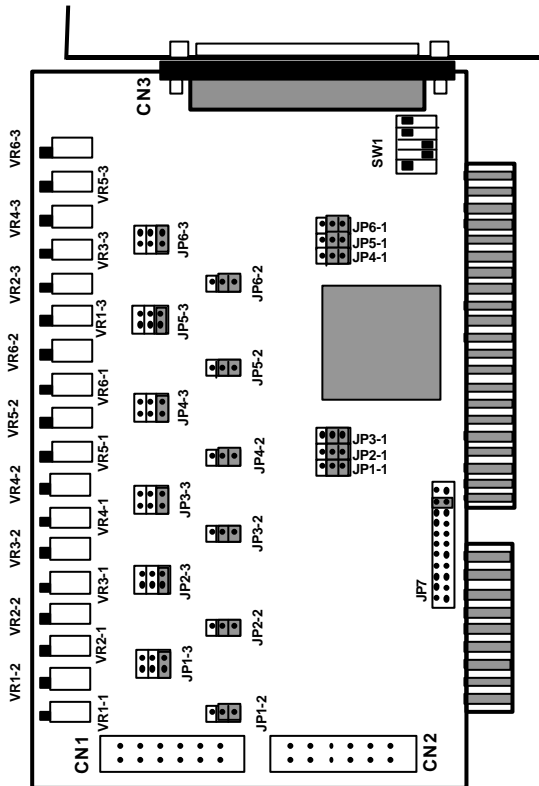

Figure 2.1 ACL-6126' s Layout

2.4 Jumper and DIP Switch Description

You can configure the output of each channel and base address by setting jumpers and DIP switches on the ACL-6126. The card's jumpers and switches are preset at the factory. Under normal circumstances, you should not need to change the jumper settings.

A jumper switch is closed (sometimes referred to as "shorted") with the plastic cap inserted over two pins of the jumper. A jumper is open with the plastic cap inserted over one or no pin(s) of the jumper.

2.5 Base Address Setting

The ACL-6126 requires 16 consecutive address locations in I/O address space. The base address of the ACL-6126 is restricted by the following conditions.

1. The base address must be within the range 200hex to 3F0hex.
2. The base address should not conflict with any PC reserved I/O address. See Appendix A.

The ACL-6126's I/O port base address is selectable by an 5 position DIP switch SW1 (refer to Table 2.1). The address settings for I/O port from Hex 200 to Hex 3F0 is described in Table 2.2 below. The default base address of your ACL-6126 is set to **hex 2C0** in the factory (see Figure 2.2).

SW1 : Base Address = 0x2C0

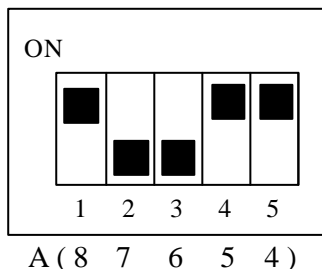

Figure 2.2 Default Base Address Setting

I/O port address(hex)	fixed A9	1 A8	2 A7	3 A6	4 A5	5 A4
200-20F	OFF (1)	ON (0)	ON (0)	ON (0)	ON (0)	ON (0)
210-21F	OFF (1)	ON (0)	ON (0)	ON (0)	ON (0)	OFF (1)
:						
(*) 2C0-2CF	OFF (1)	ON (0)	OFF (1)	OFF (1)	ON (0)	ON (0)
:						
300-30F	OFF (1)	OFF (1)	ON (0)	ON (0)	ON (0)	ON (0)
:						
3F0-3FF	OFF (1)	OFF (1)	OFF (1)	OFF (1)	OFF (1)	OFF (1)

(*) : default setting ON : 0

X : don't care OFF : 1

Note: A4, ..., A9 correspond to PC bus address lines.

2.6 IRQ Level Setting

A hardware interrupt can be triggered by the external Interrupt signal which is from **pin 17 of CN3** connector. Its corresponding interrupt IRQ levels can be selected by jumper JP7. The jumper setting is specified as below:

Note : Be aware that there is no other add-on cards sharing the same interrupt level in the system.

Interrupt Default Setting = IRQ15

(IRQ)

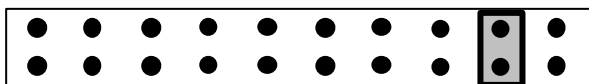

3 5 6 7 9 10 11 12 15 X

Note: External trigger source is from Pin-17 of CN3

Figure 2.3 IRQ Setting

2.7 D/A Output Configuration

The ACL-6126's output channels can be configured as different analog output styles, and they are dependent on D/A converter's *reference voltage source* and *output mode* (*Bipolar* or *Unipolar*). The reference voltage can be generated internally or by external reference voltage from the Reference Voltage Input (REF.IN) of connector P1. Each output channel and its corresponding jumpers are listed as follows.

Channel NO.	Corresponding Jumper
CH0	JP1-3
CH1	JP2-3
CH2	JP3-3
CH3	JP4-3
CH4	JP5-3
CH5	JP6-3

The jumper settings for each output channel are illustrated as below Figure 2.4 . The *internal -5V* is set as default reference voltage.

Reference Voltage Source	External Ref.	-10V Ref.	-5V Ref. (default)
Jumper Setting	 EXT -10V -5V	 EXT -10V -5V	 EXT -10V -5V

Figure 2.4 Reference Voltage Source

Besides, each output channel can be set as Bipolar or Unipolar output. Each output channel and its corresponding jumpers for mode setup are listed as follows.

Channel NO.	Corresponding Jumper for output mode
CH0	JP1-1, JP1-2
CH1	JP2-1, JP2-2
CH2	JP3-1, JP3-2
CH3	JP4-1, JP4-2
CH4	JP5-1, JP5-2
CH5	JP6-1, JP6-2

The jumper settings for output channel CH0 are illustrated as below Figure 2.5. The *Unipolar mode* is default setting.

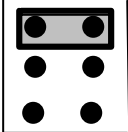
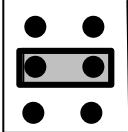
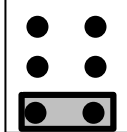
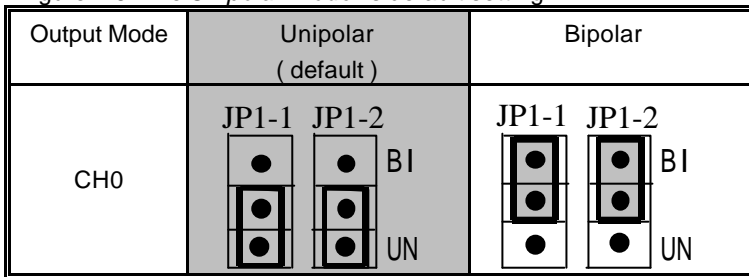
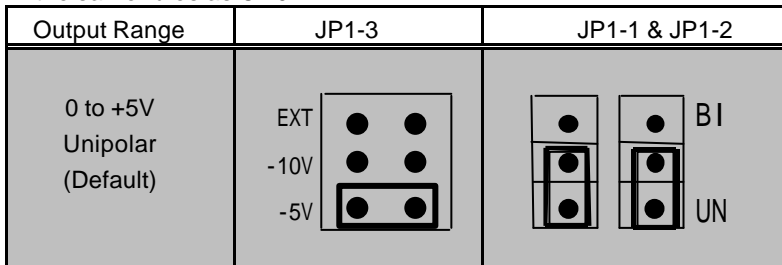
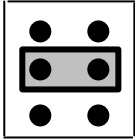
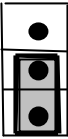
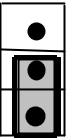
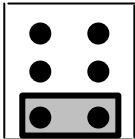
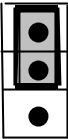
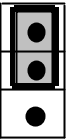
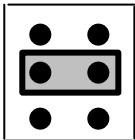
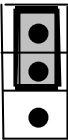
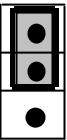
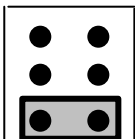
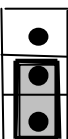
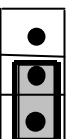
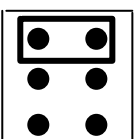
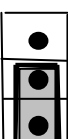
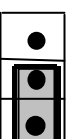

Figure 2.5 Output Mode Setting for CH0

The different output ranges of output CH0 are shown as the following table. The settings for reminder channels(CH1 ~ CH5) should follow the same rules as CH0.



<p>0V to +10V Unipolar</p>	<p>EXT </p> <p>-10V</p> <p>-5V</p>	<p> BI</p> <p> UN</p>
<p>-5V to +5V Bipolar</p>	<p>EXT </p> <p>-10V</p> <p>-5V</p>	<p> BI</p> <p> UN</p>
<p>-10V to +10V Bipolar</p>	<p>EXT </p> <p>-10V</p> <p>-5V</p>	<p> BI</p> <p> UN</p>
<p>4 mA to 20 mA</p>	<p>EXT </p> <p>-10V</p> <p>-5V</p>	<p> BI</p> <p> UN</p>
<p>External Ref.</p>	<p>EXT </p> <p>-10V</p> <p>-5V</p>	<p> BI</p> <p> UN</p>

2.8 Connector Pin Assignment

The ACL-6126 is equipped with one 37-pin D-sub (CN3) and two 20-pin insulation displacement connectors (CN1 and CN2). The CN3 is located at the rear plate; the CN1 and CN2 are located on board.

CN3 is used for analog outputs and reference voltage input, while CN2 for digital inputs and CN1 for digital outputs. Each connector's pin assignment is specified as follows:

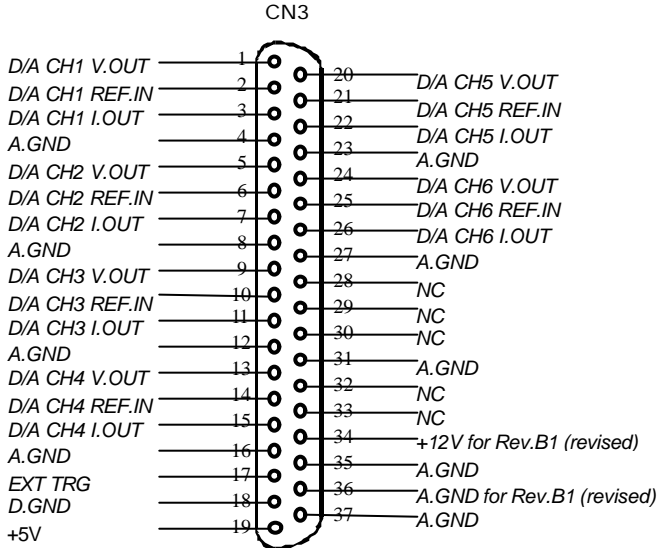

Legend :

- V.OUT: Analog Voltage Output
- I.OUT: Analog Current Output
- A.GND: Analog Ground
- D/A: Analog Output
- D.GND: Digital Ground
- REF.OUT: Reference Voltage Output
- REF.IN: Reference Voltage Input
- EXT TRG: External Interrupt Trigger
- DO : Digital Output
- DI: Digital Input

NC : No Connection

CN 1 : DIGITAL OUTPUT

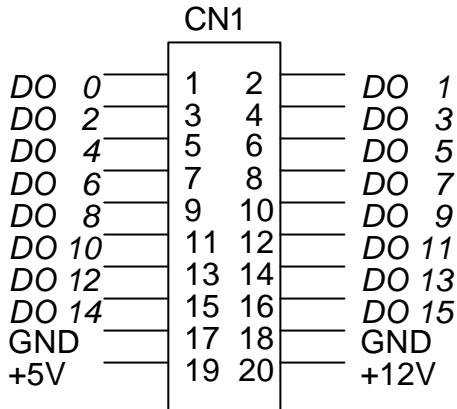

CN 2 : DIGITAL INPUT

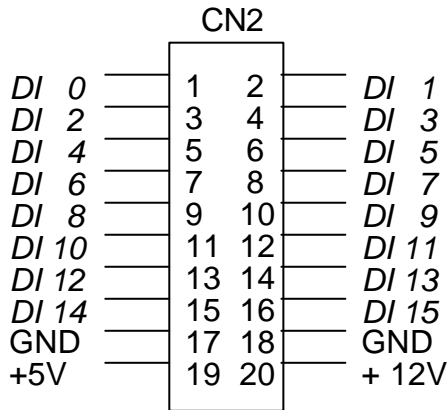

2.9 Signal Connection

A correct signal connection is quite important to send data accurately. In this section, a helpful information is present for how to make proper signal connection when the ACL-6126 is used.

Voltage Output Connection

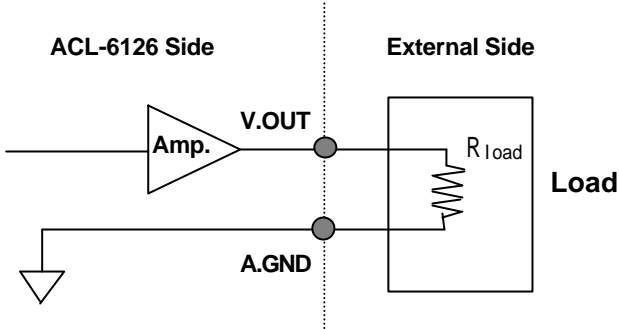

Current Sink Connection

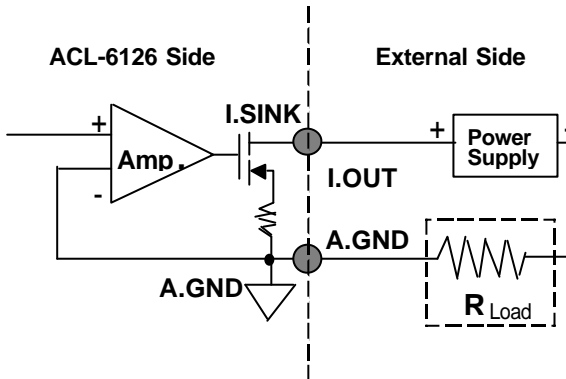

Note : For 4-20mA current sink mode, the output range should be set as **Internal Reference with -5V** and **Unipolar mode**.

The voltage bias of current sink mode should be within 8V ~ 36V. A **12V** or **24V** DC power supply is the best choice for power source.

2.10 Software Installation

The ADLINKCD includes a utility software and some demonstration programs which can help you to reduce your application programming effort and support the calibration of analog outputs.

Installation

To install the DOS library software and utilities, please follow the following installation procedures:

1. Put *ADLINK CD* into the appropriate CD-ROM drive.
2. Type the following commands to change to the card' s directory (X indicates the CD-ROM drive):
X:\>CD \NuDAQISA\6126
3. Execute the setup batch program to install the software:
X:\NuDAQISA\6126>**SETUP**

After installation, all the files of *ACL-6126 Library & Utility for DOS* are stored in C:\ADLink\6126\DOS directory.

Running Utility

After finishing the installation, you can execute the utility by typing as follows :

```
C>cd \ADLINK\6126\DOS\UTIL  
C>6126UTIL
```

C Language Programming

Three example programs in C language are supported in the directory <SAMPLES>, you can refer to these samples and modify them for your own application.

3

Registers Format

3.1 I/O Port Address

The ACL-6126 requires 16 consecutive addresses in the PC's I/O address space. The starting address (Base) is selected on the DIP switch SW1 (see Section 2.5). The following table (Table 4.1) shows the location of each register and its description.

Location	Mode	Description
Base + 0	Write	D/A #1 high byte data
Base + 1	Write	D/A #1 low byte data
Base + 2	Write	D/A #2 high byte data
Base + 3	Write	D/A #2 low byte data
Base + 4	Write	D/A #3 high byte data
Base + 5	Write	D/A #3 low byte data
Base + 6	Write	D/A #4 high byte data
Base + 7	Write	D/A #4 low byte data
Base + 8	Write	D/A #5 high byte data
Base + 9	Write	D/A #5 low byte data
Base + 10	Write	D/A #6 high byte data
Base + 11	Write	D/A #6 low byte data
Base + 12	Write	D/O Bit 8-15
Base + 13	Write	D/O Bit 0-7
Base + 14	Read	D/I Bit 8-15

Base + 15	Read	D/I Bit 0-7
-----------	------	-------------

Table 4.1 Registers Map

3.2 D/A Data Register

The D/A converter expects digital input data to be in binary right-justified format, as shown in Figure 3.1.

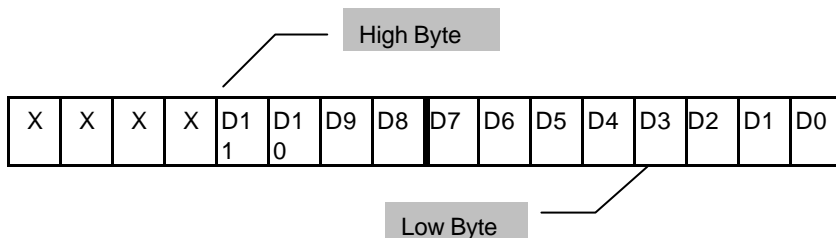

The base address from Base+0 to Base+11 are used for D/A conversion. The analog output channels and its corresponding registers are specified by table 4.2, and the details is described as table 4.3 and 4.4.

CH. No	#1	#2	#3	#4	#5	#6
High byte	Base+0	Base+2	Base+4	Base+6	Base+8	Base+10
Low byte	Base+1	Base+3	Base+5	Base+7	Base+9	Base+11

Table 4.2

Data Format :

D/A High byte data : (Base +0, +2, +4, +6, +8, +10)

Bit	7	6	5	4	3	2	1	0
	X	X	X	X	D11	D10	D9	D8

Table 4.3

D/A Low byte data : (Base +1, +3, +5, +7, +9, +11)

Bit	7	6	5	4	3	2	1	0
	D7	D6	D5	D4	D3	D2	D1	D0

Table 4.4

AD11 .. AD0 : Analog to digital data. AD0 is Least Significant Bit, and AD11 is Most Significant Bit.

X : Don't care

Two analog output range are provided by the ACL-6126, that is, Unipolar and Bipolar. The numbering of the converted data will have different presentation for different output range.

Unipolar Numbering

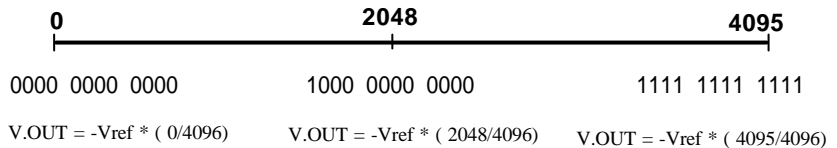

Example :

Converted Data = 2047
 Binary Code = 0111 1111 1111
 Vref = -5V
 $V.OUT = -(-5 V) * (2047/4096) = 2.498 V$

Bipolar Numbering

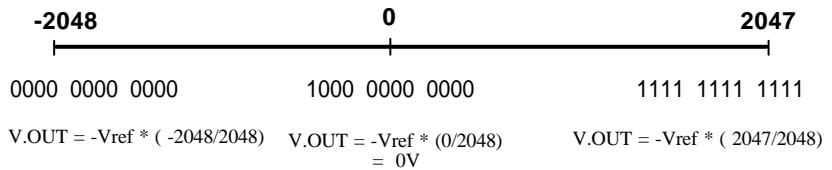

Example :

Converted Data = 500
 Binary Code = 1001 1111 0100
 Vref = -5V
 $V.OUT = -(-5 V) * (500/2048) = 1.220 V$

3.3 Digital I/O Register

There are 16 digital input channels and 16 digital output channels are provided by ACL-6126. These I/O channels use the address Base + 12 and Base + 13 for output channels, and the address Base + 14 and Base + 15 for input channels. The data format is shown as follows:

Data Format :

Digital I/O : (Base + 12, Base + 13, Base + 14, and Base + 15)

Bit	7	6	5	4	3	2	1	0
Base + 12 (Write, Output)	DO15	DO14	DO13	DO12	DO11	DO10	DO9	DO8
Base + 13 (Write, Output)	DO7	DO6	DO5	DO4	DO3	DO2	DO1	DO0
Base + 14 (Read, Input)	DI15	DI14	DI13	DI12	DI11	DI10	DI9	DI8
Base + 15 (Read, Input)	DI7	DI6	DI5	DI4	DI3	DI2	DI1	DI0

Table 4.5

3.4 Demonstration Programs

Some demonstration programs and a very simple analog output and digital I/O library are included in the Utility Software. The description of each file for demonstration is listed as following table :

DA_DEMO. C :	analog output demonstration program
DI_DEMO. C :	digital input demonstration program
DO_DEMO. C :	digital output demonstration program

We provide source code of all programs above, you can refer to these demonstrate programs and library to speed up your own application development.

Product Warranty/Service

Seller warrants that equipment furnished will be free from defects in material and workmanship for a period of one year from the confirmed date of purchase of the original buyer and that upon written notice of any such defect, Seller will, at its option, repair or replace the defective item under the terms of this warranty, subject to the provisions and specific exclusions listed herein.

This warranty shall not apply to equipment that has been previously repaired or altered outside our plant in any way as to, in the judgment of the manufacturer, affect its reliability. Nor will it apply if the equipment has been used in a manner exceeding its specifications or if the serial number has been removed.

Seller does not assume any liability for consequential damages as a result from our products uses, and in any event our liability shall not exceed the original selling price of the equipment.

The equipment warranty shall constitute the sole and exclusive remedy of any Buyer of Seller equipment and the sole and exclusive liability of the Seller, its successors or assigns, in connection with equipment purchased and in lieu of all other warranties expressed implied or statutory, including, but not limited to, any implied warranty of merchant ability or fitness and all other obligations or liabilities of seller, its successors or assigns.

The equipment must be returned postage-prepaid. Package it securely and insure it. You will be charged for parts and labor if you lack proof of date of purchase, or if the warranty period is expired.