

PC-HELPER

Analog Input Board for PCI

AD12-16(PCI)EV

High-Resolution Analog Input Board for PCI

AD16-16(PCI)EV

High-Speed Analog Input Board for PCI

AD12-16U(PCI)EV

High-Speed & Resolution Analog Input Board
for PCI

AD16-16U(PCI)EV

User's Guide

CONTEC CO.,LTD.

Check Your Package

Thank you for purchasing the CONTEC product.

The product consists of the items listed below.

Check, with the following list, that your package is complete. If you discover damaged or missing items, contact your retailer.

Product Configuration List

- Board (One of the following) ...1
[AD12-16(PCI)EV, AD16-16(PCI)EV, AD12-16U(PCI)EV or AD16-16U(PCI)EV]
- First step guide ...1
- CD-ROM *1 [API-PAC(W32)]...1

*1 The CD-ROM contains the driver software and User's Guide (this guide)

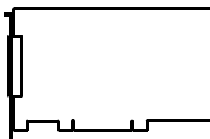

Board

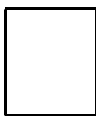

First step guide



CD-ROM
[API-PAC(W32)]

Copyright

Copyright 2005 CONTEC CO., LTD. ALL RIGHTS RESERVED

No part of this document may be copied or reproduced in any form by any means without prior written consent of CONTEC CO., LTD.

CONTEC CO., LTD. makes no commitment to update or keep current the information contained in this document. The information in this document is subject to change without notice.

All relevant issues have been considered in the preparation of this document. Should you notice an omission or any questionable item in this document, please feel free to notify CONTEC CO., LTD.

Regardless of the foregoing statement, CONTEC assumes no responsibility for any errors that may appear in this document or for results obtained by the user as a result of using this product.

Trademarks

MS, Microsoft, Windows and Windows NT are trademarks of Microsoft Corporation. Other brand and product names are trademarks of their respective holder.

Table of Contents

Check Your Package	i
Copyright	ii
Trademarks	ii
Table of Contents.....	iii

1. BEFORE USING THE PRODUCT	1
------------------------------------	----------

About the Board.....	1
Features.....	1
Support Software	2
Cable & Connector (Option).....	4
Accessories (Option).....	4
Customer Support	5
Web Site.....	5
Limited Three-Years Warranty	5
How to Obtain Service	5
Liability.....	5
Safety Precautions	6
Safety Information	6
Handling Precautions	7
Environment	8
Inspection.....	8
Storage	8
Disposal	8

2. SETUP	9
-----------------	----------

What is Setup?	9
Using the Board under Windows Using the Driver Library API-PAC(W32).....	9
Using the Board under Windows Using Software Other than the Driver Library API-PAC(W32)	9
Using the Board under an OS Other than Windows	10
Step 1 Installing the Software.....	11
About the Driver.....	11
Starting the Install Program.....	12
Select API-AIO(WDM)	13
Select API-AIO(98/PC).....	14
Step 2 Setting the Hardware	16
Parts of the Board and Factory Defaults	16
Setting the Board ID.....	20
Setting the Analog Input.....	20
Setting the Analog Output.....	23

Setting the Counter Control and Digital I/O Signals.....	24
Plugging the Board	25
Step 3 Installing the Hardware.....	26
Turning on the PC.....	26
When Using the API-AIO(WDM).....	26
When Using the API-AIO(98/PC).....	28
Step 4 Initializing the Software.....	31
When Using the API-AIO(WDM).....	31
When Using the API-AIO(98/PC).....	33
Step 5 Checking Operations with the Diagnosis Program	34
What is the Diagnosis Program?.....	34
Check Method	34
Using the Diagnosis Program for Use of API-AIO(WDM).....	35
Using the Diagnosis Program for Use of API-AIO(98/PC).....	38
Setup Troubleshooting	41
Symptoms and Actions	41
If your problem cannot be resolved	41

3. EXTERNAL CONNECTION	43
-------------------------------	-----------

How to connect the connectors.....	43
Connector shape.....	43
Connector Pin Assignment	45
Analog Input Signal Connection.....	47
Single-ended Input.....	47
Differential Input	48
Analog Output Signal Connection.....	49
Digital I/O signals and Control signals Connection	50

4. FUNCTIONS	51
---------------------	-----------

Analog Input Function	51
1. Setting the Conversion Conditions	52
2. Starting/Stopping Operation	57
3. Monitoring the Status and Acquiring Data.....	58
4.Reset.....	61
5. Extended function.....	61
Analog Output Function	62
Digital Input Function.....	64
Digital Output Function	65
Counter Function.....	66

5. ABOUT SOFTWARE	67
--------------------------	-----------

CD-ROM Directory Structure.....	67
---------------------------------	----

About Software for Windows.....	68
When using the API-AIO(WDM)	69
Accessing the Help File.....	69
Using Sample Programs	70
Usage of Utility Program	72
When using the API-AIO(98/PC)	75
Accessing the Help File.....	75
Using Sample Programs	76
Using the Utility Program	78
Uninstalling the Driver Libraries	80
About Software for Linux	81
Driver Software Install Procedure.....	81
Accessing the Help File.....	82
Using Sample Programs	82
Uninstalling the driver.....	82

6.	ABOUT HARDWARE	83
-----------	-----------------------	-----------

For detailed technical information	83
Hardware specification	84
Block Diagram.....	92
Timing of Sampling Control Signals.....	93
About Calibration	94
Differences between past analog E and this product	95



1. Before Using the Product

About the Board

< AD12-16(PCI)EV >, < AD16-16(PCI)EV >, < AD12-16U(PCI)EV > and < AD16-16U(PCI)EV > are PCI-compliant interface boards that convert analog input signals to digital data (performing analog-to-digital conversion). < AD12-16(PCI)EV >, < AD16-16(PCI)EV >, < AD12-16U(PCI)EV > and < AD16-16U(PCI)EV > carries high-capacity buffer memory for 16MB of data for analog input, allowing background sampling to be performed in a variety of trigger conditions.

< AD12-16(PCI)EV >, < AD16-16(PCI)EV >, < AD12-16U(PCI)EV > and < AD16-16U(PCI)EV > also has one analog output channel, four channels for TTL digital input, and four channels for TTL digital output.

< AD12-16(PCI)EV >, < AD16-16(PCI)EV >, < AD12-16U(PCI)EV > and < AD16-16U(PCI)EV > are available in four different models, depending on the combination of the conversion speed (10 or 1 μ sec per channel) and resolution (12 or 16 bits) of the analog input section.

Using the bundled API function library package [API-PAC(W32)], you can create Windows application software for this board in your favorite programming language supporting Win32 API functions, such as Visual Basic or Visual C++.

It can also collect data easily without a program when the data logger software [C-LOGGER] stored on the attached CD-ROM is used. With plug-ins for the dedicated libraries, the board also supports MATLAB and LabVIEW.

This product is partly improved from the past analog E series; it is an upward-compatible product. Basically, this product can therefore be used in the same way as the analog E series. This product is different in specification from the E series. The difference point is shown in "Differences between past analog E and this product".

Features

Available in four models depending on the combination of conversion speed and resolution.

The < AD12-16(PCI)EV > is the type that performs A-D conversion at a conversion speed of 10 μ sec per channel and a resolution of 12-bit.

The < AD16-16(PCI)EV > is the high-precision type that performs A-D conversion at a conversion speed of 10 μ sec per channel and a resolution of 16-bit.

The < AD12-16U(PCI)EV > is the high-speed type that performs A-D conversion at a conversion speed of 1 μ sec per channel and a resolution of 12-bit.

The < AD16-16U(PCI)EV > is the high-speed, high-precision type that performs A-D conversion at a conversion speed of 1 μ sec per channel and a resolution of 16-bit.

Equipped with high-capacity buffer memory for 16MB of data and a variety of sampling control functions FIFO or RING buffer memory for 16MB of data, allowing sampling to be performed as a background task independent of the processing power of the PC.

Capable of starting and stopping sampling not only by software commands but depending on the strength of an analog signal (via conversion data comparison) or by detection of a TTL-level signal (external trigger).

Sixteen single-ended channels or eight differential channels (Analog input function)

These boards allow either single-ended or differential input mode that is selected with on-board jumpers. The order of channels subject to signal conversion can be preset in the dedicated register. Using an optional unit, a board can increase the maximum number of input channels (up to 32 channels) and perform simultaneous sampling.

Mixed on-board channels for analog output and digital I/O

One channel for analog output, four channels for TTL digital input, and four channels for TTL digital output mixed on the board.

Compact PCI short-size board with a wealth of advanced functions

Abundant optional units

Providing a variety of options available for extending the functions, including buffer amplifier, simultaneous sampling, insulation & current/thermocouple input, lowpass filter, and cables.

Supported to the data logger software [C-LOGGER]

Supporting the data logger software [C-LOGGER] that enables the graph display of recorded signal data, file saving, and dynamic transfer to the spreadsheet software program "Excel"

Plug-ins for the dedicated libraries, the board also supports MATLAB and LabVIEW.

We offer a dedicated library [ML-DAQ], which allows you to use this product on MATLAB by the MathWorks as well as another dedicated library [VI-DAQ], which allows you to use the product on LabVIEW.

These dedicated libraries are available, free of charge (downloadable), on our web site.

Support Software

You should use CONTEC support software according to your purpose and development environment.

Driver Library **API-PAC(W32)** (Bundled)

API-PAC(W32) is the library software that provides the commands for CONTEC hardware products in the form of Windows standard Win32 API functions (DLL). It makes it easy to create high-speed application software taking advantage of the CONTEC hardware using various programming languages that support Win32 API functions, such as Visual Basic and Visual C++.

It can also be used by the installed diagnosis program to check hardware operations.

CONTEC provides download services (at <http://www.contec.com/apipac/>) to supply the updated drivers and differential files.

For details, read Help on the bundled CD-ROM or visit the CONTEC's Web site.

< Operating environment >

OS	Windows XP, Server 2003, 2000, Me, 98, etc..
Adaptation language	Visual C++ .NET, Visual C# .NET, Visual Basic .NET, Visual C++, Visual Basic, Delphi, C++Builder, etc..

Linux version of analog I/O driver **API-AIO(LNX)** (Supplied: Stored on the API-PAC(W32) CD-ROM)

This driver is used to control CONTEC analog I/O boards (cards) from within Linux.

You can control CONTEC I/O boards easily using the shared library called from the user application, the device driver (module) for kernel version, and the board (card) configuration program (config).

CONTEC provides download services (at <http://www.contec.com/apipac/>) to supply the updated drivers and differential files.

For details, read Help on the bundled CD-ROM or visit the CONTEC's Web site.

< Operating environment >

OS RedHatLinux, TurboLinux, etc..
(For details on supported distributions, refer to Help available after installation.)

Adaptation language gcc, etc..

Data Logger Software **C-LOGGER** (Supplied: Stored on the API-PAC(W32) CD-ROM)

C-LOGGER is a data logger software program compatible with our analog I/O products. This program enables the graph display of recorded signal data, zoom observation, file saving, and dynamic transfer to the spreadsheet software "Excel". No troublesome programming is required.

CONTEC provides download services (at <http://www.contec.com/clogger>) to supply the updated drivers.

For details, refer to the C-LOGGER Users Guide or our website.

< Operating Environment >

OS Windows XP, Server 2003, 2000

Data Acquisition library for MATLAB **ML-DAQ** (Available for downloading (free of charge) from the CONTEC web site.)

This is the library software which allows you to use our analog I/O device products on MATLAB by the MathWorks. Each function is offered in accordance with the interface which is integrated in MATLAB's Data Acquisition Toolbox. See <http://www.contec.com/mldaq/> for details and download of ML-DAQ.

Data acquisition VI library for LabVIEW **VI-DAQ** (Available for downloading (free of charge) from the CONTEC web site.)

This is a VI library to use in National Instruments LabVIEW.

VI-DAQ is created with a function form similar to that of LabVIEW's Data Acquisition VI, allowing you to use various devices without complicated settings.

See <http://www.contec.com/vidaq/> for details and download of VI-DAQ.

Cable & Connector (Option)

Flat Cable with One 37-pin D-Type Connector	: PCA37P-1.5 (1.5m)
Shielded Cable with One 37-pin D-Type Connector	: PCA37PS-0.5P (0.5m)
	: PCA37PS-1.5P (1.5m)
Shielded Cable with Two 37-pin D-Type Connectors	: PCB37PS-0.5P (0.5m)
	: PCB37PS-1.5P (1.5m)
Flat Cable with One 15-pin D-Type Connector	: PCA15P-1.5 (1.5m)
Flat Cable with Two 15-pin D-Type Connectors	: PCB15P-1.5 (1.5m) *1
Coaxial Cable for Single-ended Inputs	: PCC16PS-1.5 (1.5m)
	: PCC16PS-3 (3m)
2 Wires Shielded Cable for Differential Inputs	: PCD8PS-1.5 (1.5m)
	: PCD8PS-3 (3m)
Flat Cable with 1 Sided 16-Pin Header Connector (1.5m)	: DT/E1
Conversion Cable (16Pin to 15Pin) with Bracket	: DT/E2
D-SUB37P Male Connector Set (5pieces)	: CN5-D37M

*1 For FTP-15 only

Accessories (Option)

Termination panel with Screw Terminals for Spade Lugs	: DTP-3(PC)
Termination panel with Screw Terminals	: DTP-4(PC)
Termination panel with BNC connectors for Analog Multi-function Boards	: ATP-16 *2
Termination panel with BNC connectors for Analog Multi-function Boards	: ATP-16E *2
Buffer amplifier termination panel for analog multi-function box	: ATBA-16E *2
Termination panel for Digital I/O on Analog Multi-function Boards	: FTP-15 *3
Screw Terminal	: EPD-37A *2
Screw Terminal	: EPD-37 *2
16 Channel Simultaneous Sample & Hold Accessory	: ATSS-16 *2
8ch-Isolation Accessory Board for Analog Inputs	: ATII-8A *2
8ch Gain Operation Amplifier Accessory Board for Analog Input	: ATLF-8 *2
16CH Multiplexer Sub-Board for AD12-16(PCI)EV and AD16-16(PCI)EV	: ATCH-16A(PCI)
16CH Multiplexer Sub-Board for AD12-16U(PCI)EV and AD16-16U(PCI)EV	: ATUH-16A(PCI)

*2 A PCB37PS -*P optional cable is required separately. (0.5m is recommended.)

*3 A DT/E2 and PCB15P-1.5 optional cable is required separately.

* Check the CONTEC's Web site for more information on these options.

Customer Support

CONTEC provides the following support services for you to use CONTEC products more efficiently and comfortably.

Web Site

Japanese <http://www.contec.co.jp/>

English <http://www.contec.com/>

Chinese <http://www.contec.com.cn/>

Latest product information

CONTEC provides up-to-date information on products.

CONTEC also provides product manuals and various technical documents in the PDF.

Free download

You can download updated driver software and differential files as well as sample programs available in several languages.

Note! For product information

Contact your retailer if you have any technical question about a CONTEC product or need its price, delivery time, or estimate information.

Limited Three-Years Warranty

CONTEC products are warranted by CONTEC CO., LTD. to be free from defects in material and workmanship for up to three years from the date of purchase by the original purchaser.

Repair will be free of charge only when this device is returned freight prepaid with a copy of the original invoice and a Return Merchandise Authorization to the distributor or the CONTEC group office, from which it was purchased.

This warranty is not applicable for scratches or normal wear, but only for the electronic circuitry and original boards. The warranty is not applicable if the device has been tampered with or damaged through abuse, mistreatment, neglect, or unreasonable use, or if the original invoice is not included, in which case repairs will be considered beyond the warranty policy.

How to Obtain Service

For replacement or repair, return the device freight prepaid, with a copy of the original invoice. Please obtain a Return Merchandise Authorization number (RMA) from the CONTEC group office where you purchased before returning any product.

* No product will be accepted by CONTEC group without the RMA number.

Liability



The obligation of the warrantor is solely to repair or replace the product. In no event will the warrantor be liable for any incidental or consequential damages due to such defect or consequences that arise from inexperienced usage, misuse, or malfunction of this device.

Safety Precautions

Understand the following definitions and precautions to use the product safely.

Safety Information

This document provides safety information using the following symbols to prevent accidents resulting in injury or death and the destruction of equipment and resources. Understand the meanings of these labels to operate the equipment safely.

 DANGER	DANGER indicates an imminently hazardous situation which, if not avoided, will result in death or serious injury.
 WARNING	WARNING indicates a potentially hazardous situation which, if not avoided, could result in death or serious injury.
 CAUTION	CAUTION indicates a potentially hazardous situation which, if not avoided, may result in minor or moderate injury or in property damage.

Handling Precautions

DANGER

Do not use the product where it is exposed to flammable or corrosive gas. Doing so may result in an explosion, fire, electric shock, or failure.

CAUTION

- There are switches and jumpers on the board that need to be set in advance.
Be sure to check these before installing the board.
 - Only set the switches and jumpers on the board to the specified settings.
Otherwise, the board may malfunction, overheat, or cause a failure.
 - Do not strike or bend the board.
Otherwise, the board may malfunction, overheat, cause a failure or breakage.
 - Do not touch the board's metal plated terminals (edge connector) with your hands.
Otherwise, the board may malfunction, overheat, or cause a failure.
If the terminals are touched by someone's hands, clean the terminals with industrial alcohol.
 - Do not plug or unplug the cables which are connected to the board while the PC or expansion unit is still turned on.
Otherwise, the board may malfunction, overheat, or cause a failure.
Be sure that the personal computer power is turned off.
 - Do not install or remove the board to or from the expansion slot while the computer's power or expansion unit is turned on.
Otherwise, the board may malfunction, overheat, or cause a failure.
Be sure that the personal computer power is turned off.
 - Make sure that your PC or expansion unit can supply ample power to all the boards installed.
Insufficiently energized boards could malfunction, overheat, or cause a failure.
 - The specifications of this product are subject to change without notice for enhancement and quality improvement.
Even when using the product continuously, be sure to read the manual and understand the contents.
 - Do not modify the product. CONTEC will bear no responsibility for any problems, etc., resulting from modifying this product.
 - Regardless of the foregoing statements, CONTEC is not liable for any damages whatsoever (including damages for loss of business profits) arising out of the use or inability to use this CONTEC product or the information contained herein.
-

Environment

Use this product in the following environment. If used in an unauthorized environment, the board may overheat, malfunction, or cause a failure.

Operating temperature

0 - 50°C

Operating humidity

10 - 90%RH (No condensation)

Corrosive gases

None

Floating dust particles

Not to be excessive

Inspection

Inspect the product periodically as follows to use it safely.

- Check that the bus connector of the board and its cable have been plugged correctly.

- Check that the board has no dust or foreign matter adhering.

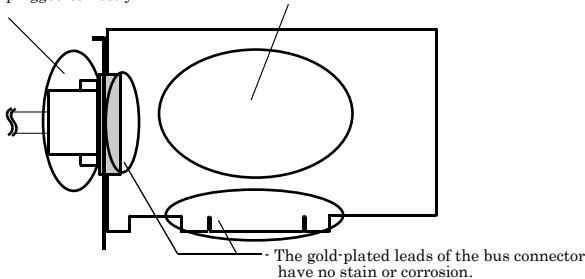

- The gold-plated leads of the bus connector have no stain or corrosion.

Storage

When storing this product, keep it in its original packing form.

- (1) Put the board in the storage bag.
- (2) Wrap it in the packing material, then put it in the box.
- (3) Store the package at room temperature at a place free from direct sunlight, moisture, shock, vibration, magnetism, and static electricity.

Disposal

When disposing of the product, follow the disposal procedures stipulated under the relevant laws and municipal ordinances.

2. Setup

This chapter explains how to set up the board.

What is Setup?

Setup means a series of steps to take before the product can be used.

Different steps are required for software and hardware.

The setup procedure varies with the OS and applications used.

Using the Board under Windows

Using the Driver Library API-PAC(W32)

This section describes the setup procedure to be performed before you can start developing application programs for the board using the bundled CD-ROM “Driver Library API-PAC(W32)”.

Taking the following steps sets up the software and hardware. You can use the diagnosis program later to check whether the software and hardware function normally.

Step 1 Installing the Software

Step 2 Setting the Hardware

Step 3 Installing the Hardware

Step 4 Initializing the Software

Step 5 Checking Operations with the Diagnosis Program

If Setup fails to be performed normally, see the “Setup Troubleshooting” section at the end of this chapter.

Using the Board under Windows

Using Software Other than the Driver Library API-PAC(W32)

For setting up software other than API-PAC(W32), refer to the manual for that software. See also the following parts of this manual as required.

This chapter Step 2 Setting the Hardware

This chapter Step 3 Installing the Hardware

Chapter 3 External Connection

Chapter 6 About Hardware

Using the Board under an OS Other than Windows

For using the board under Linux, see the following parts of this manual.

This chapter Step 2 Setting the Hardware

Chapter 3 External Connection

Chapter 5 About Software

Chapter 6 About Hardware

For using the board under an OS other than Windows, Linux, see the following parts of this manual.

This chapter Step 2 Setting the Hardware

Chapter 3 External Connection

Chapter 6 About Hardware

Step 1 Installing the Software

This section describes how to install the API function libraries.

Before installing the hardware on your PC, install the Driver libraries from the bundled API-PAC(W32) CD-ROM.

The following description assumes the operating system as Windows XP. Although some user interfaces are different depending on the OS used, the basic procedure is the same.

About the Driver

There are the two drivers "API-AIO(WDM)" and "API-AIO(98/PC)" among the analog input/output drivers.

API-AIO(WDM) is a new driver to perform analog input and output under Windows.

It was developed aiming at "more easily use and more convenient" "more high performance" corresponding to the product version of API-AIO(98/PC) so far.

When using an analog input/output device, we recommend you use API-AIO(WDM). Although API-AIO(WDM) is designed to correspond with future new OS and new device, it is not suitable for Windows NT 4.0 or Windows 95 and ISA Bus.

As a result, please use API-AIO(98/PC) under these environments.

Here introduces the selection guide that can help choose the available drivers easily.

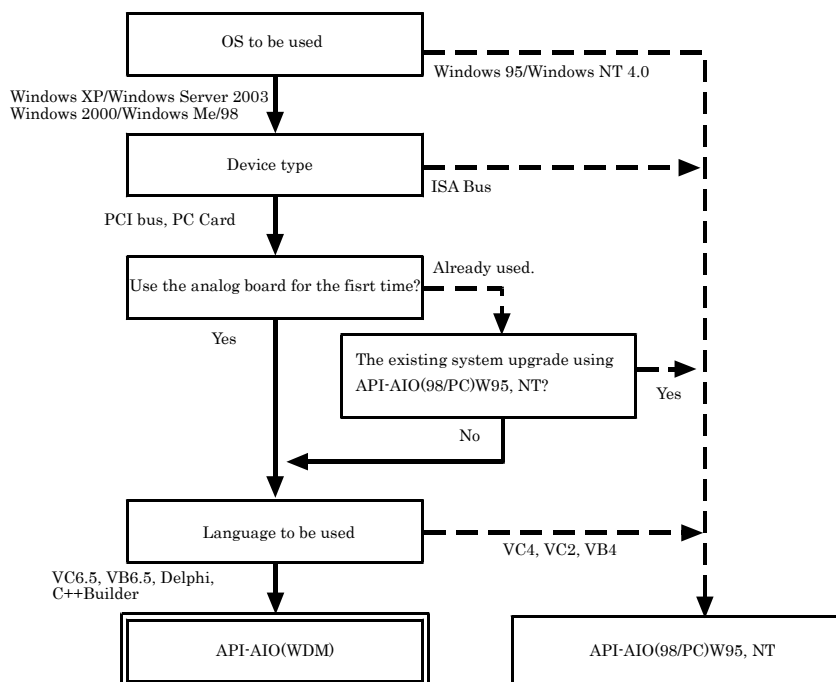

Starting the Install Program

- (1) Load the CD-ROM [API-PAC(W32)] on your PC.
- (2) The API-PAC(W32) Installer window appears automatically.
If the panel does not appear, run (CD-ROM drive letter):\AUTORUN.exe.
- (3) Click on the [Install Development or Execution Environment] button.

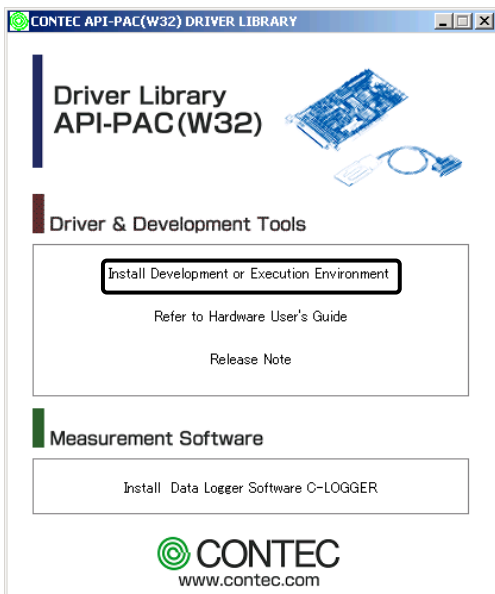

CAUTION

Before installing the software in Windows XP, Server 2003, 2000, or NT, log in as a user with administrator privileges.

Select API-AIO(WDM)

Select API-AIO(WDM)

- (1) **The following dialog box appears to select “Driver Type” and “Install Type”.**
- (2) **Select the "High Functionality WDM Analog I/O driver".**
- (3) **Click on the [Install] button.**

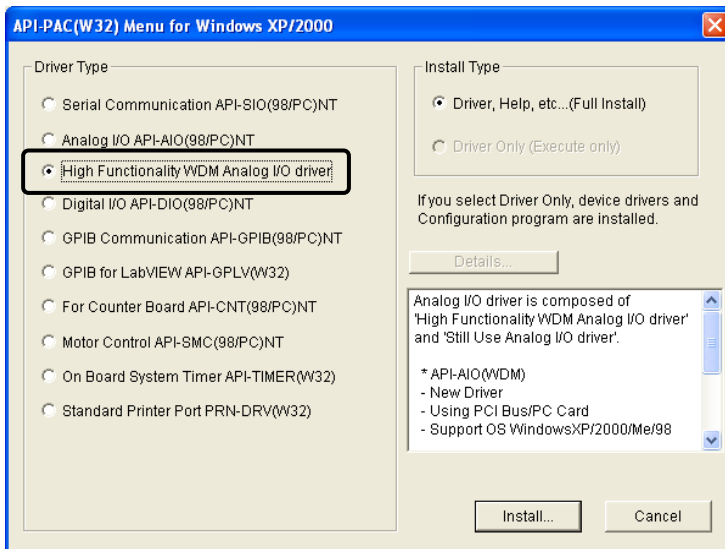

- * Clicking the [Details] button displays detailed information about API-AIO(WDM) and API-AIO(98/PC).

Run the installation

- (1) **Complete the installation by following the instructions on the screen.**
- (2) The Readme file appears when the installation is complete.

You have now finished installing the software.

Select API-AIO(98/PC)

Select API-AIO(98/PC)

- (1) The following dialog box appears to select “Driver Type” and “Install Type”.
- (2) Select “Analog I/O API-AIO(98/PC)NT”.
- (3) Select “Driver, Help, etc..(Full Install)”.
- (4) Click on the [Install] button.

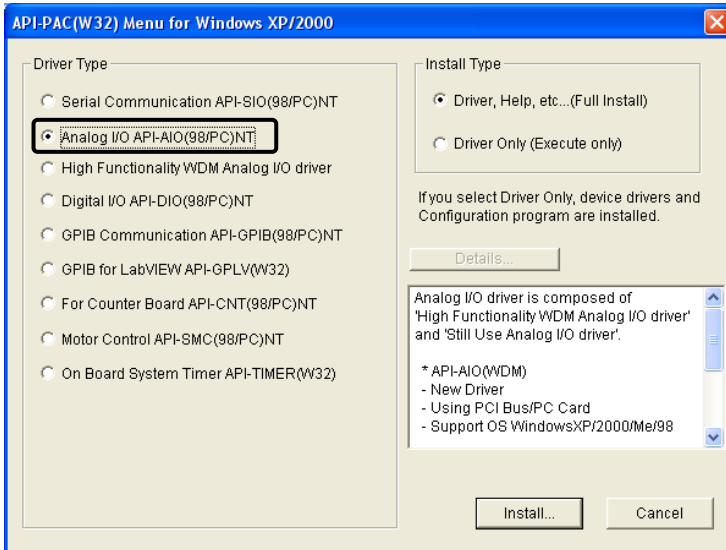

- * Clicking on the [Details ...] button displays detailed information on API-AIO(WDM), API-AIO(98/PC).

Executing the Installation

- (1) **Follow the on-screen instructions to proceed to install.**
- (2) When the required files have been copied, the “Perform a hardware setup now” and “Show readme file” check boxes are displayed.

When you are installing the software or hardware for the first time:

1) Uncheck “Perform a hardware setup now”.

2) Click on the [Finish] button.

Go to Step 2 to set and plug the hardware.

* When the hardware has already been installed:

Check “Perform a hardware setup now”, then go to Step 4 “Initializing the Software”.



You have now finished installing the software.

Step 2 Setting the Hardware

This section describes how to set the board and plug it on your PC.

The board has some switches and jumper to be preset.

Check the on-board switches and jumpers before plugging the board into an expansion slot.

The board can be set up even with the factory defaults untouched. You can change board settings later.

Parts of the Board and Factory Defaults

Figure 2.1. - Figure 2.4. show the names of major parts on the board.

Note that the switch and jumper setting shown below is the factory default.

AD12-16(PCI)EV

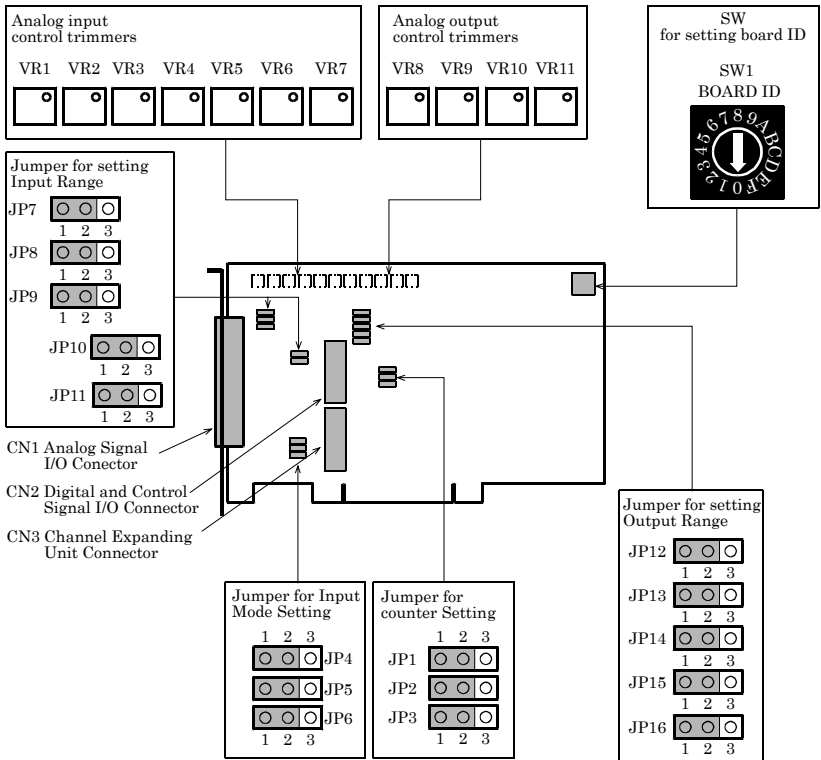

Figure 2.1. Part Names < AD12-16(PCI)EV >

AD16-16(PCI)EV

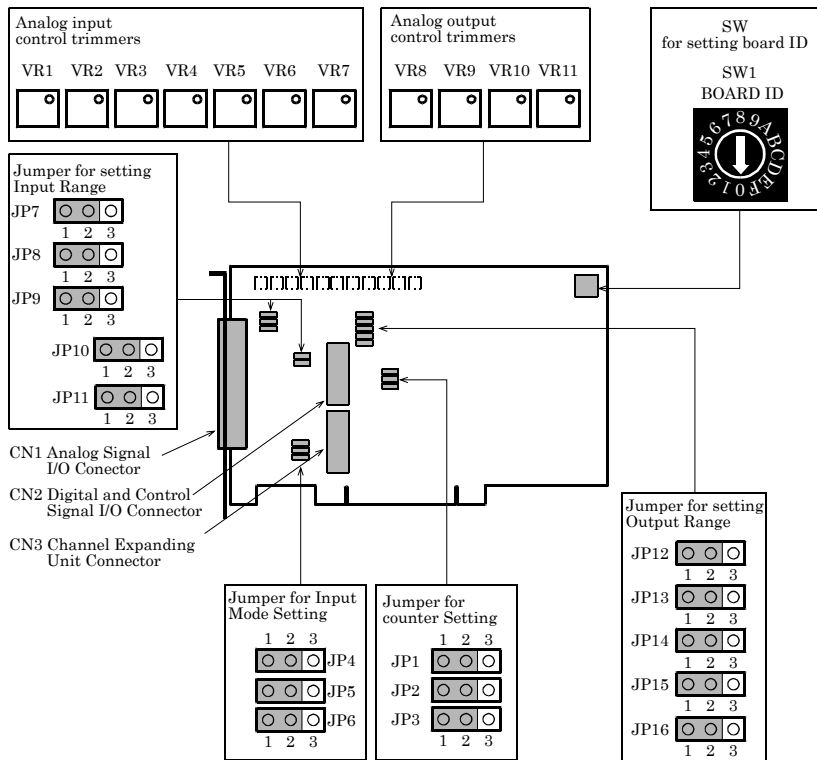

Figure 2.2. Part Names < AD16-16(PCI)EV >

AD12-16U(PCI)EV

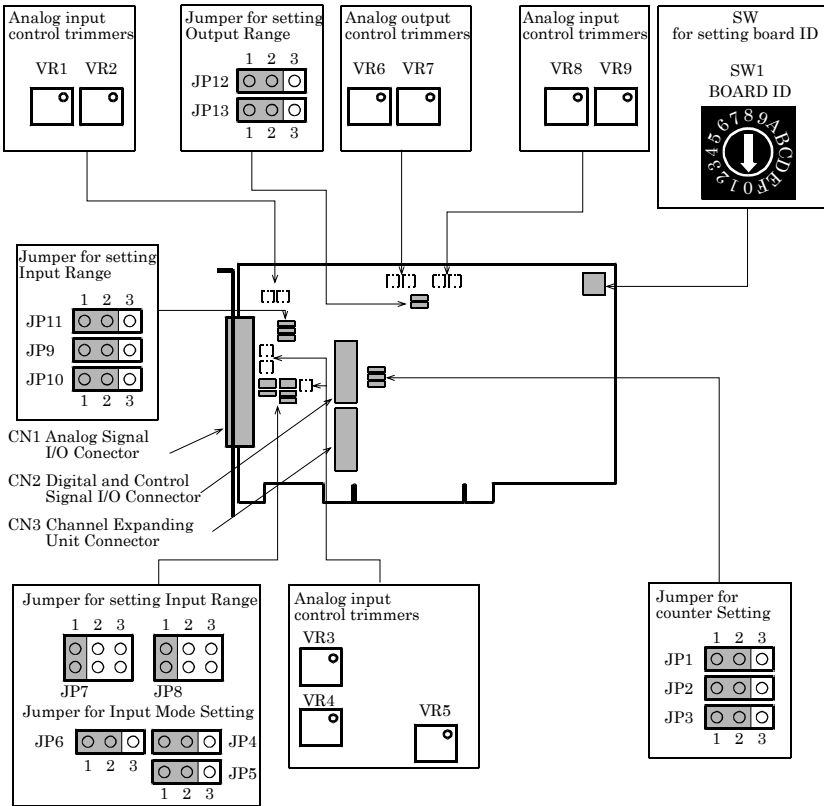

Figure 2.3. Part Names < AD12-16U(PCI)EV >

AD16-16U(PCI)EV

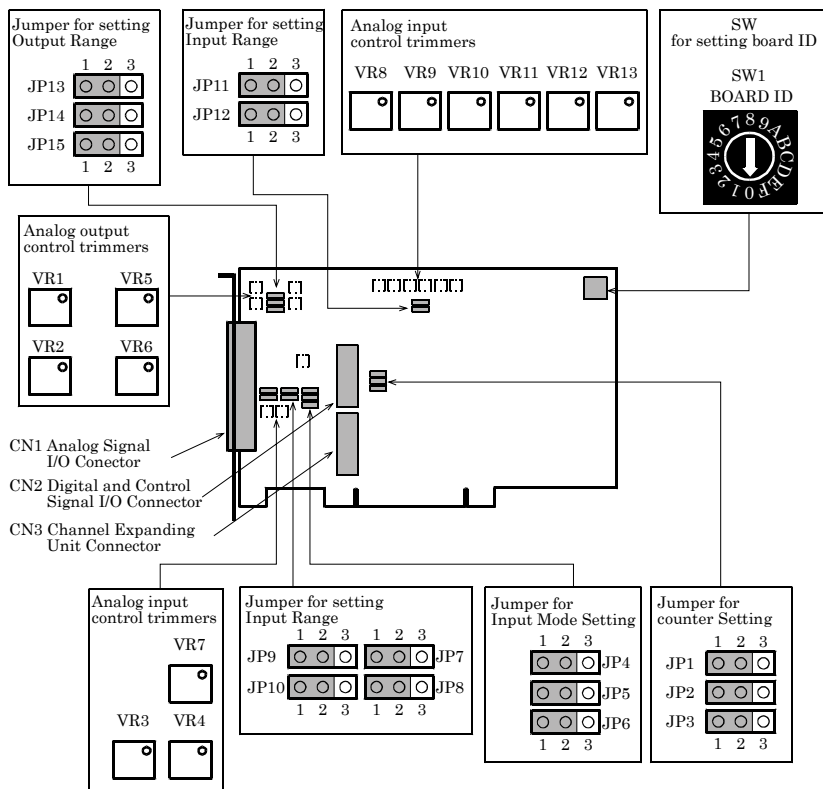

Figure 2.4. Part Names < AD16-16U(PCI)EV >

Setting the Board ID

If you install two or more boards on one personal computer, assign a different ID value to each of the boards to distinguish them.

The board IDs can be set from 0 - Fh to identify up to sixteen boards.

If only one board is used, the original factory setting (Board ID = 0) should be used.

Setting Procedure

To set the board ID, use the rotary switch on the board. Turn the SW1 knob to set the board ID as shown below.

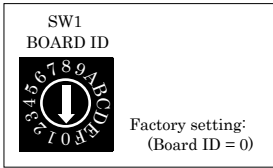

Figure 2.5. Board ID Settings (SW1)

Setting the Analog Input

The analog input is set by specifying the input mode and input range.

For the input mode setting function, see Chapter 4 “Functions”.

Setting the Input Mode

The input mode is the method of connecting analog input signals. The single-ended and differential input modes are available.

The jumper settings for these modes are common to the AD12-16U(PCI)EV, AD16-16U(PCI)EV, AD12-16(PCI)EV and AD16-16(PCI)EV.

Use JP4 - JP6 to set the desired input mode.

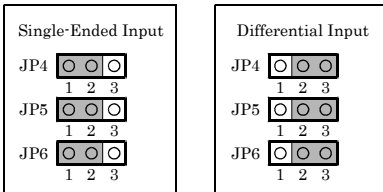

Figure 2.6. Setting the Input Mode



CAUTION

Do not set the jumpers to any strapping pattern other than those specified above. Doing so can result in a fault in the board.

Setting the Input Range

The input range indicates the range of voltages of analog input signals.

The board converts the voltages in the preset input range into digital signals according to the resolution.

The input range is common to all channels; it is not possible to set a different input range for each channel.

Figures 2.7 - 2.10 illustrates the jumper settings on each board.

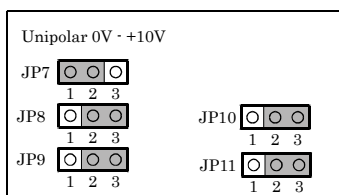
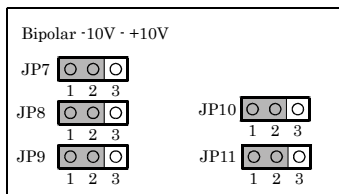

Figure 2.7. Setting the Input Range < AD12-16(PCI)EV >

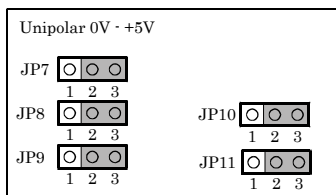
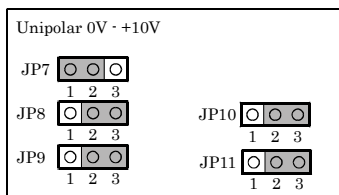
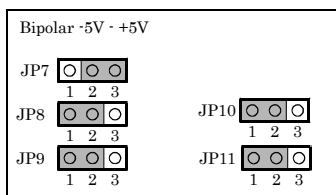
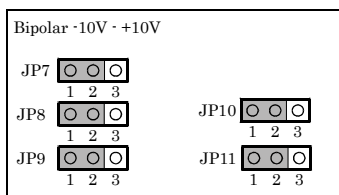

Figure 2.8. Setting the Input Range < AD16-16(PCI)EV >

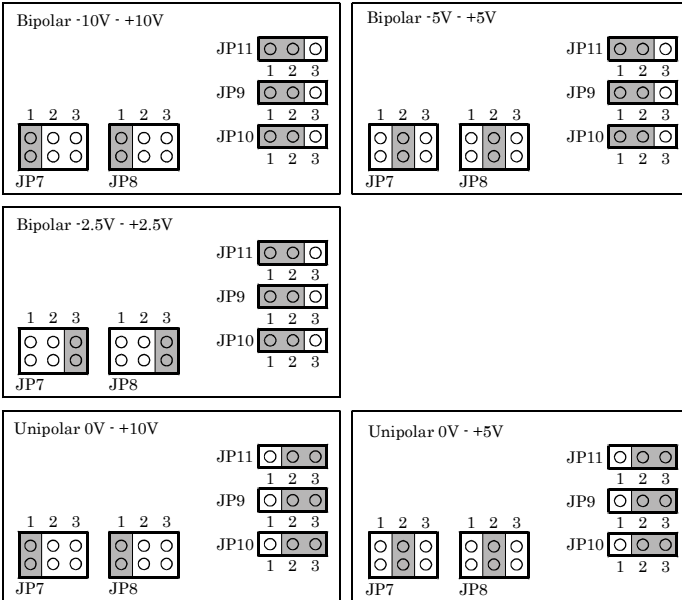

Figure 2.9. Setting the Input Range < AD12-16U(PCI)EV >

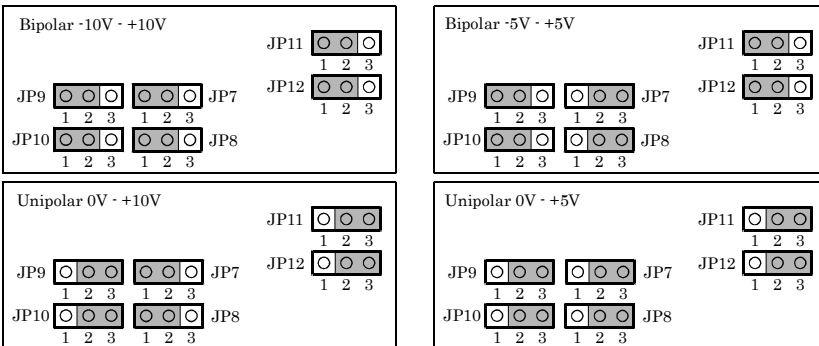

Figure 2.10. Setting the Input Range < AD16-16U(PCI)EV >

⚠ CAUTION

Do not set the jumpers to any strapping pattern other than those specified above. Doing so can result in a fault in the board.

Setting the Analog Output

The analog output is set by specifying the output range.

The output range indicates the range of voltages of analog output signals.

The board converts digital signals into voltages in the preset output range according to the resolution.

Figures 2.11 - 2.14 illustrates the jumper settings on each board.

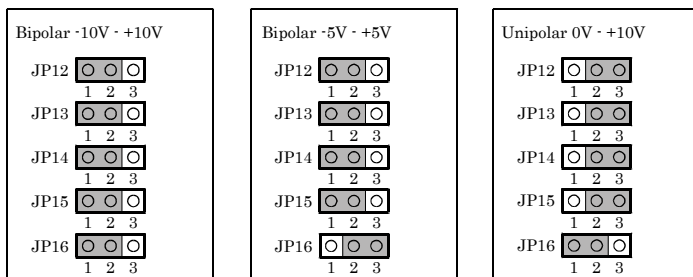

Figure 2.11. Setting the Analog Output < AD12-16(PCI)EV >

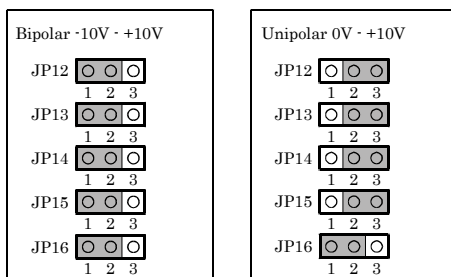

Figure 2.12. Setting the Analog Output < AD16-16(PCI)EV >

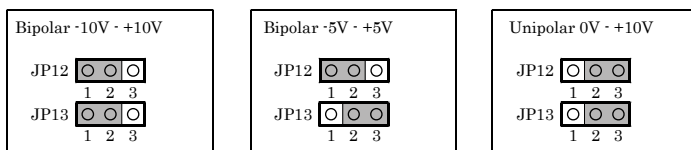

Figure 2.13. Setting the Analog Output < AD12-16U(PCI)EV >

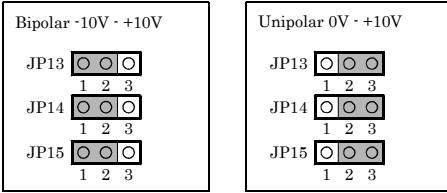

Figure 2.14. Setting the Analog Output < AD16-16U(PCI)EV >

⚠ CAUTION

Do not set the jumpers to any strapping pattern other than those specified above. Doing so can result in a fault in the board.

Setting the Counter Control and Digital I/O Signals

The board has a component equivalent to the i8254, which contains three 16-bit counters. You can set the connections of counter control signals (counter output signal, gate signal, and clock input signal). Some of the counter control signals and digital I/O signals are shared, which are set altogether. For the digital input, digital output, and counter functions, see Chapter 4 “Functions”.

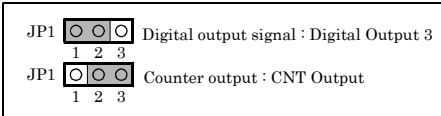

Figure 2.15. Settings the Signals to Be Connected to CN2[10pin] Digital Output3 and CNT Output

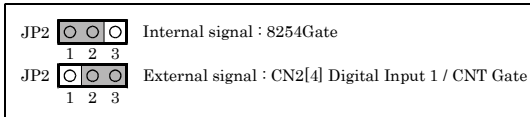

Figure 2.16. Settings the Signals to Be Connected to gate of COUNTER1/COUNTER2

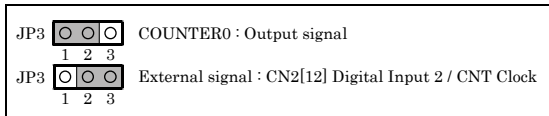

Figure 2.17. Settings the Signals to Be Connected to Clock of

⚠ CAUTION

- External signals for counter control must be TTL-level signals.
- CNTCLK and CNTGATE serve also as DI2 and DI1, respectively.
- Only one of the CNTOUT and DO3, which is selected by JP1, is output from CN2.
- In API-AIO(WDM), the counter function is not supported. Please match the jumper to the setting when you ship it.

Plugging the Board

- (1) Before plugging the board, shut down the system, unplug the power code of your PC.
- (2) Remove the cover from the PC so that the board can be mounted.
- (3) Plug the board into an expansion slot.
- (4) Attach the board bracket to the PC with a screw.
- (5) Put the cover back into place.



Applicable PCI bus slots

PCI bus slots used in PCs have keys to prevent 5V and 3.3V PCI bus boards from being accidentally plugged into wrong bus slots. This board can be plugged into both of the 5V and 3.3V PCI bus slots.

<PCI bus slot>

5-V PCI bus slot

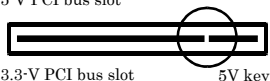

3.3-V PCI bus slot

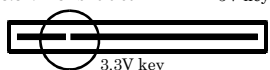

<PCI bus board>

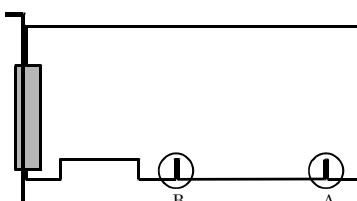

A : Slit for 5-V PCI bus slot
B : Slit for 3.3-V PCI bus slot

⚠ CAUTION

- Do not touch the board's metal plated terminals (edge connector) with your hands. Otherwise, the board may malfunction, overheat, or cause a failure. If the terminals are touched by someone's hands, clean the terminals with industrial alcohol.
- Do not install or remove the board to or from the slot while the computer's power is turned on. Otherwise, the board may malfunction, overheat, or cause a failure. Doing so could cause trouble. Be sure that the personal computer or the I/O expansion unit power is turned off.
- Make sure that your PC or expansion unit can supply ample power to all the boards installed. Insufficiently energized boards could malfunction, overheat, or cause a failure.
- Power supply from the PCI bus slot at +5V is required.

Step 3 Installing the Hardware

For using an expansion board under Windows, you have to let the OS detect the I/O addresses and IRQ to be used by the board. The process is referred to as installing the hardware.

In the case of using two or more boards, make sure you install one by one with the Add New Hardware Wizard.

Turning on the PC

Turn on the power to your PC.

CAUTION

- The board cannot be properly installed unless the resources (I/O addresses and interrupt level) for the board can be allocated. Before attempting to install the board, first determine what PC resources are free to use.
 - The resources used by each board do not depend on the location of the PCI bus slot or the board itself. If you remove two or more boards that have already been installed and then remount one of them on the computer, it is unknown that which one of the sets of resources previously assigned to the two boards is assigned to the remounted board. In this case, you must check the resource settings.
-

When Using the API-AIO(WDM)

- (1) The “Found New Hardware Wizard” will be started.
Select “Install from a list or specific location[Advanced]”, then click on the [Next] button.



- (2) Specify that folder on the CD-ROM which contains the setup information (INF) file to register the board.



Source folder

The setup information (INF) file is contained in the following folder on the bundled CD-ROM.

\INF\WDM\AIO

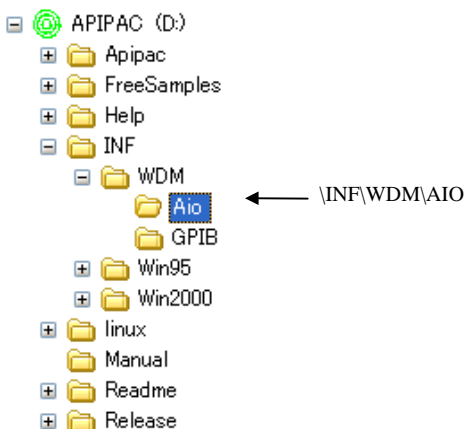

You have now finished installing the hardware.

When Using the API-AIO(98/PC)

- (1) The “Found New Hardware Wizard” will be started.
Select “Install from a list or specific location[Advanced]”, then click on the [Next] button.
If you are using Windows NT 4.0, the “Found New Hardware Wizard” is not started.
Go to Step 4 “Initializing the Software”.



- (2) Specify that folder on the CD-ROM which contains the setup information (INF) file to register the board.



Source folder

The setup information (INF) file is contained in the following folder on the bundled CD-ROM.

Windows XP, 2000 \INF\Win2000\Aio\PCI
 Windows Me, 98, 95 \INF\Win95\Aio\PCI

Example of specifying the folder for use under Windows XP

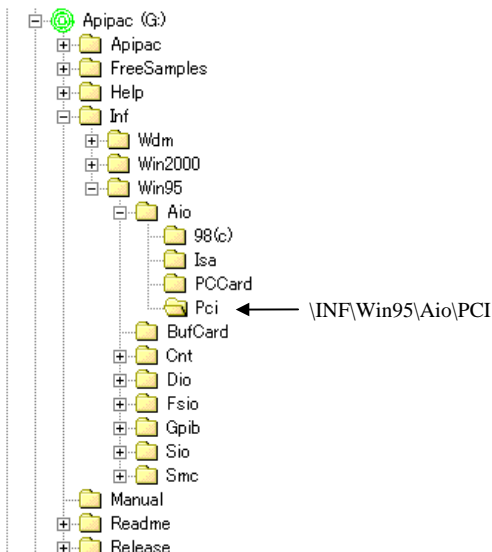

⚠ CAUTION

In Windows XP, the Hardware Wizard displays the following alert dialog box when you have located the INF file. This dialog box appears, only indicating that the relevant driver has not passed Windows Logo testing, and it can be ignored without developing any problem with the operation of the board.

In this case, click on the [Continue Anyway] button.

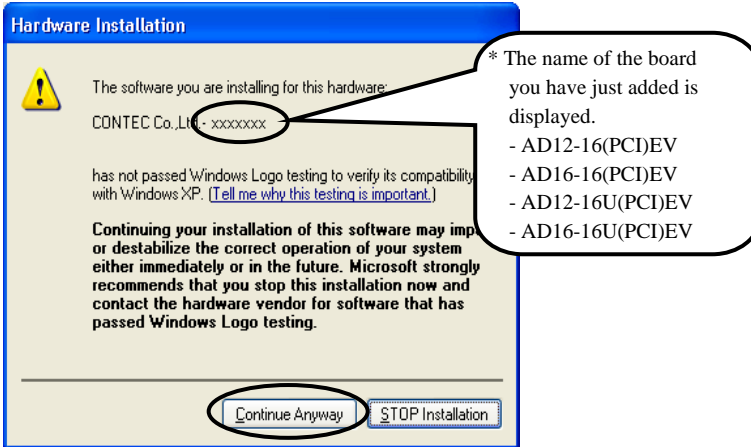

You have now finished installing the hardware.

Step 4 Initializing the Software

The driver library requires initial settings to determine the execution environment. This is called driver library initialization.

When Using the API-AIO(WDM)

Setting the device name

- (1) Run Device Manager. From [My Computer] - [Control Panel], select [System] and then select the [Device Manager] tab.

(You can also open Device Manager by right clicking on My Computer and selecting Properties.)

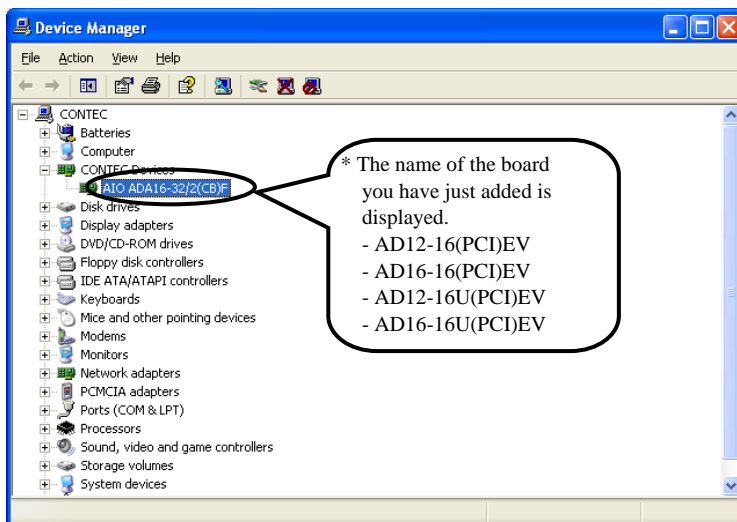

- (2) The installed hardware appears under the CONTEC Devices node. Open the CONTEC Devices node and select the device you want to setup (the device name should appear highlighted). Click [Properties].

(3) The property page for the device opens.

Enter the device name in the common settings tab page and then click [OK].

The device name you set here is used later when programming.

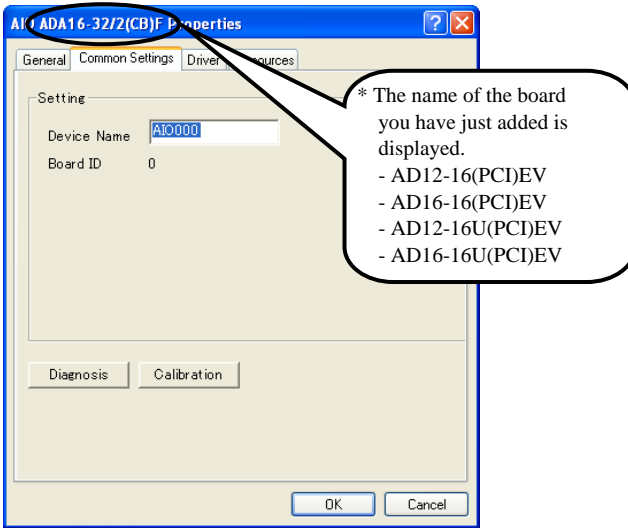

* The initial device name that appears is a default value. You can use this default name if you wish.

* Make sure that you do not use the same name for more than one device.

You have now finished installing the initial setting of Software.

When Using the API-AIO(98/PC)

Invoking API-TOOL Configuration

- (1) Open the Start Menu, then select “Programs” – “CONTEC API-PAC(W32)” – “API-TOOL Configuration”.

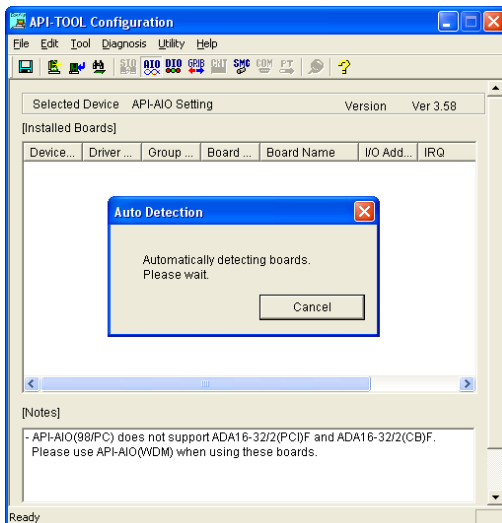

- (2) API-TOOL Configuration detects boards automatically.
The detected boards are listed.

Updating the Settings

- (1) Select “Save setting to registry...” from the “File” menu.

You have now finished installing the initial setting of Software.

Step 5 Checking Operations with the Diagnosis Program

Program

Use the diagnosis program to check that the board and driver software work normally, thereby you can confirm that they have been set up correctly.

What is the Diagnosis Program?

The diagnosis program diagnoses the states of the board and driver software.

It can also be used as a simple checker when an external device is actually connected.

Using the “Diagnosis Report” feature reports the driver settings, the presence or absence of the board, I/O status, and interrupt status.

Check Method

To check analog I/O data, connect the signal.

The diagrams below show examples of using channel 0 on the AD12-16U(PCI)EV. For details on the connections, see Chapter 3 “External Connection”. Check the board with the factor defaults untouched.

Wiring Diagram

< Analog input >

- Single-Ended Input

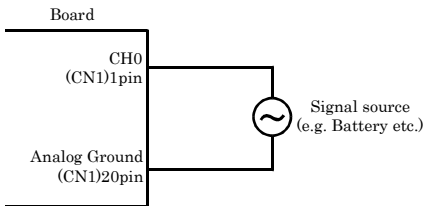

- Differential Input

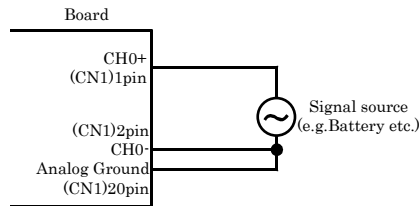

⚠ CAUTION

- To check the analog input in differential input mode, set the jumpers to change the input mode setting in advance. For details, see “Setting the Analog Input” in this chapter.
- Input data remains indeterminate when no input pin is connected. The input pin for the channel not connected to the signal source must be connected to the analog ground. For details, see “Chapter 3 External Connection”.

< Analog output >

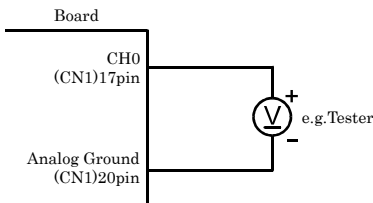
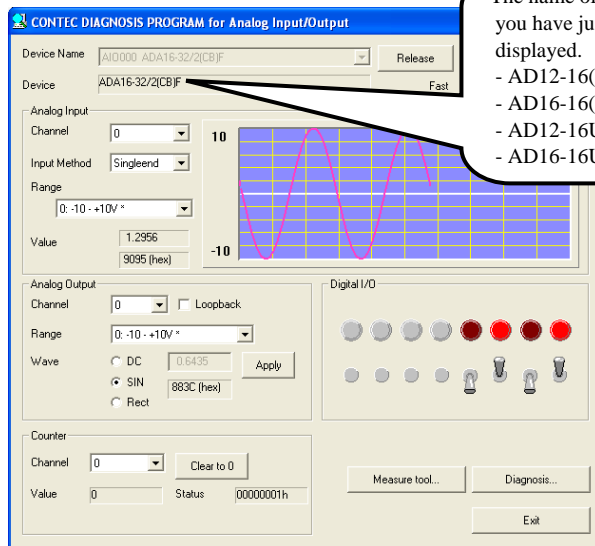
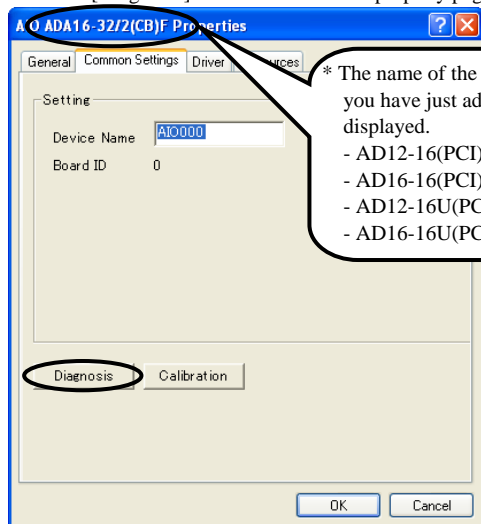

Figure 2.18. Wiring Diagram

Using the Diagnosis Program for Use of API-AIO(WDM)

Starting the Diagnosis Program

Click the [Diagnosis] button on the device property page to start the diagnosis program.



Analog input

You can select the desired input channel and input range from the lists.

Input data is plotted on a graph.

Analog output

You can select the desired output channel and output range from the lists.

You can set the output data to DC (constant voltage), sine wave, or square wave.

Digital input / output

The upper row of circular lamps indicates the digital input states. Red indicates the bit is ON and brown indicates OFF.

Clicking the lower row of switches turns the digital output bits ON or OFF.

Diagnosis Report

- (1) The diagnosis report saves detailed data, including the device settings and settings for each channel, to a text file and displays the file for you to view.

Clicking [Diagnosis Report] prompts you to specify where to save the report text file.

```

CAioRep.txt - Notepad
File Edit Format View Help
-----
CONTEC Analog I/O diagnostic report
-----
** CAioDiag.exe program **
Date:2004/05/06 07:08:09
OS :Microsoft Windows XP 5.1.2600 Service Pack 1

[Device information]
Device Name AI0000
Device ADA16-32/2(CB)P

[File Information]
G:\WINDOWS\SYSTEM32\CAIO.DLL 1, 3, 0, 0
G:\WINDOWS\SYSTEM32\CMESSAGE.OCX 1, 0, 0, 1
G:\WINDOWS\SYSTEM32\CAIODEL.EXE 1, 1, 3, 0 2003/09/29 01:13
G:\WINDOWS\SYSTEM32\CAIOP32.DLL 1, 1, 2, 0 2003/08/27 01:12
G:\WINDOWS\SYSTEM32\DRIVERS\CAIO.SYS 1, 1, 2, 0 2003/10/31 01:30
G:\WINDOWS\SYSTEM32\CAIODIAG.EXE 1, 1, 4, 0 2003/10/31 01:14

[Diagnosis]
Initial result [0] Normality completion
Interrupt [0] Normality completion

Analog input 32CH
Input method:Singleend
CH00 [0] Normality completion DATA: 3.74(AFE4hex) RANGE:-10 - +10V
CH01 [0] Normality completion DATA: 0.16(8200hex) RANGE:-10 - +10V
CH02 [0] Normality completion DATA: -0.70(7701hex) RANGE:-10 - +10V
CH03 [0] Normality completion DATA: -0.53(793Dhex) RANGE:-10 - +10V
CH04 [0] Normality completion DATA: -0.93(7416hex) RANGE:-10 - +10V
CH05 [0] Normality completion DATA: -0.75(7659hex) RANGE:-10 - +10V
CH06 [0] Normality completion DATA: -0.63(77FChex) RANGE:-10 - +10V
CH07 [0] Normality completion DATA: -0.28(7C6Dhex) RANGE:-10 - +10V
CH08 [0] Normality completion DATA: -0.86(7309hex) RANGE:-10 - +10V
CH09 [0] Normality completion DATA: -0.77(7623hex) RANGE:-10 - +10V
CH10 [0] Normality completion DATA: -0.43(7A84hex) RANGE:-10 - +10V
CH11 [0] Normality completion DATA: -0.21(7D50hex) RANGE:-10 - +10V
CH12 [0] Normality completion DATA: -0.38(7B32hex) RANGE:-10 - +10V
CH13 [0] Normality completion DATA: -0.16(7DF6hex) RANGE:-10 - +10V
CH14 [0] Normality completion DATA: -0.12(7E77hex) RANGE:-10 - +10V
CH15 [0] Normality completion DATA: -0.34(7BA1hex) RANGE:-10 - +10V
CH16 [0] Normality completion DATA: -0.54(7914hex) RANGE:-10 - +10V
CH17 [0] Normality completion DATA: -0.44(7A52hex) RANGE:-10 - +10V
CH18 [0] Normality completion DATA: -0.52(794Chex) RANGE:-10 - +10V
CH19 [0] Normality completion DATA: -0.41(7ACAhex) RANGE:-10 - +10V
CH20 [0] Normality completion DATA: -0.68(774Fhex) RANGE:-10 - +10V
CH21 [0] Normality completion DATA: -0.39(7AF6hex) RANGE:-10 - +10V

```

- (2) The diagnosis report contains the following data.

- Version of OS
- Device Information
- File Information

Initialization, interrupts, current input or output state for each channel

Using the Diagnosis Program for Use of API-AIO(98/PC)

Starting the Diagnosis Program

After selecting the board in [API-TOOL Configuration], run the diagnosis program. Follow the on-screen instructions.

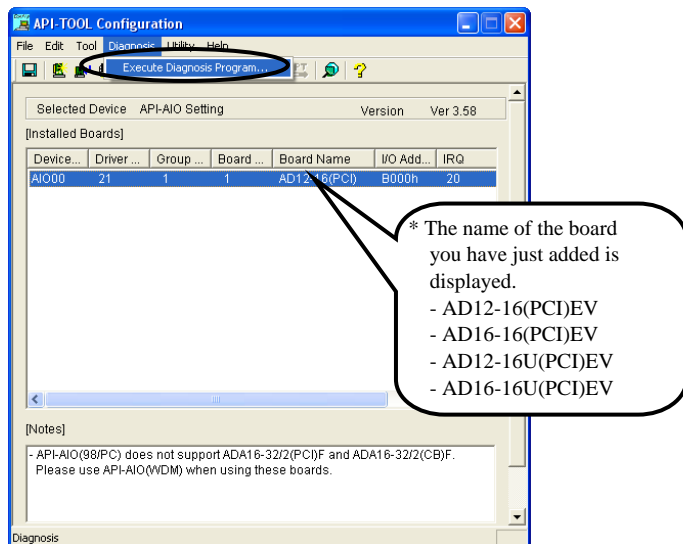

Checking the Analog Input/Output

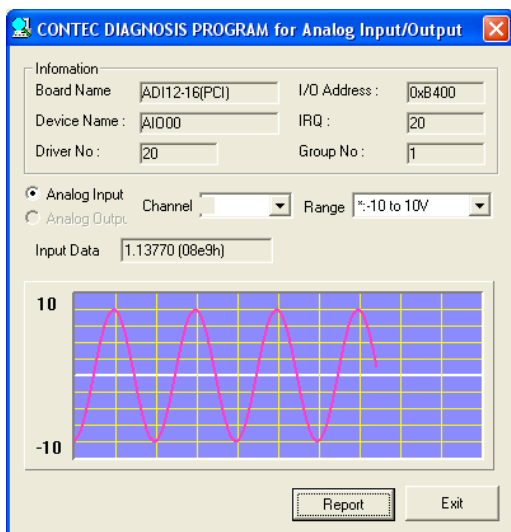

Analog input

You can select the desired input channel and input range from the lists.

Input data is plotted on a graph.

Analog output

You can select the desired output channel and output range from the lists.

Diagnosis Report

- (1) Clicking on the [Report] button displays detailed data such as a board, channel settings and the diagnosis results while saving them in text format.

The results are saved and displayed as a text file (AioRep.txt) in the install folder (CONTEC/CONTECW95).

The Diagnosis Program performs “board presence/absence check”, “interrupt test”, “driver file test”, “board setting test”, and so on.

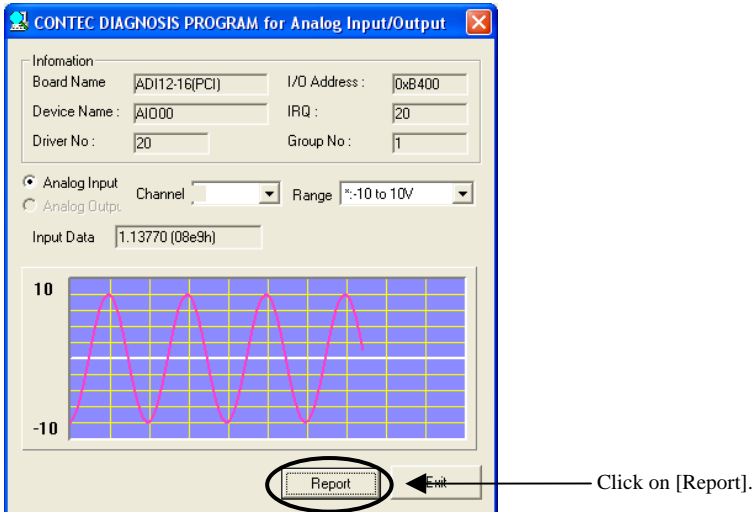

- (2) A diagnosis report is displayed as shown below.

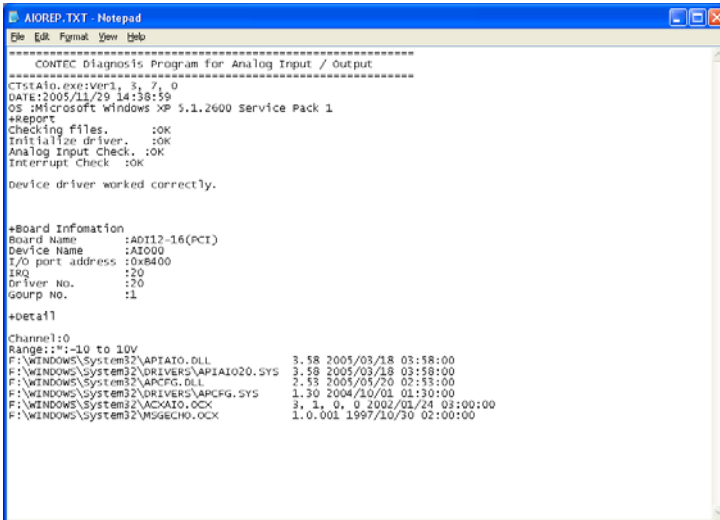

Setup Troubleshooting

Symptoms and Actions

Data input or output does not operate correctly

- Run the diagnosis program to check that the device is registered and whether any initialization errors have occurred.
- Is there a problem with the device settings, wiring, or similar? Check the I/O range setting. Also, the input data will be undefined if the wiring terminals are not connected. Ensure that the channels you are using are correctly connected. Connect unused channels to analog ground.
- For voltage input, check by connecting a battery or similar if you do not have any other suitable signal source. Also check that connecting to analog ground reads correctly as 0V.

The board works with the Diagnosis Program but not with an application.

The Diagnosis Program is coded with API-TOOL functions. As long as the board operates with the Diagnosis Program, it is to operate with other applications as well. In such cases, review your program while paying attention to the following points:

- Check the return values of the API functions.
- Refer to the source code for the sample programs.

The OS won't normally get started or detect the device.

Refer to the "Troubleshooting" section of API-AIO(WDM) HELP.

If your problem cannot be resolved

Contact your retailer.

3. External Connection

This chapter describes the interface connectors on the board and the external I/O circuits. Check the information available here when connecting an external device.

How to connect the connectors

Connector shape

To connect an external device to this board, plug the cable from the device into the interface connector (CN1, CN2) shown below.

The board has two interface connectors: the analog I/O connector (CN1: 37-pin female D-SUB connector) and the control signal connector (CN2: 16-pin pin-header) for digital input/output and counter control.

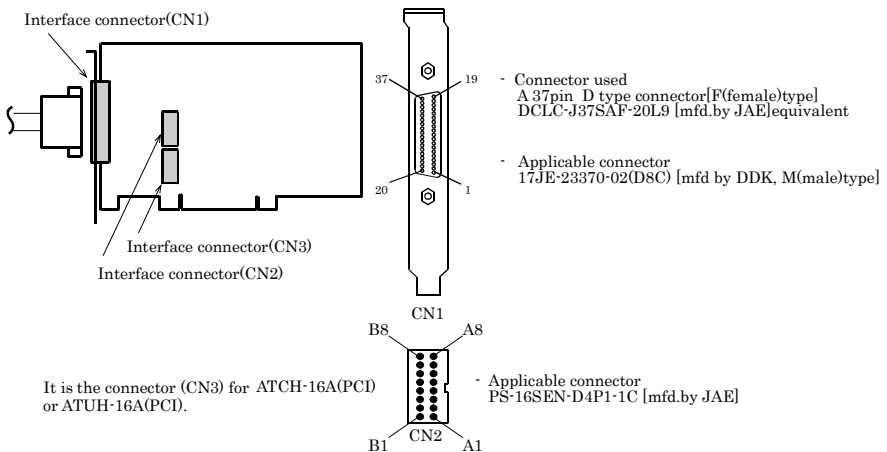

* Please refer to chapter 1 for more information on the supported cable and accessories.

Figure 3.1. Interface Connector Shape

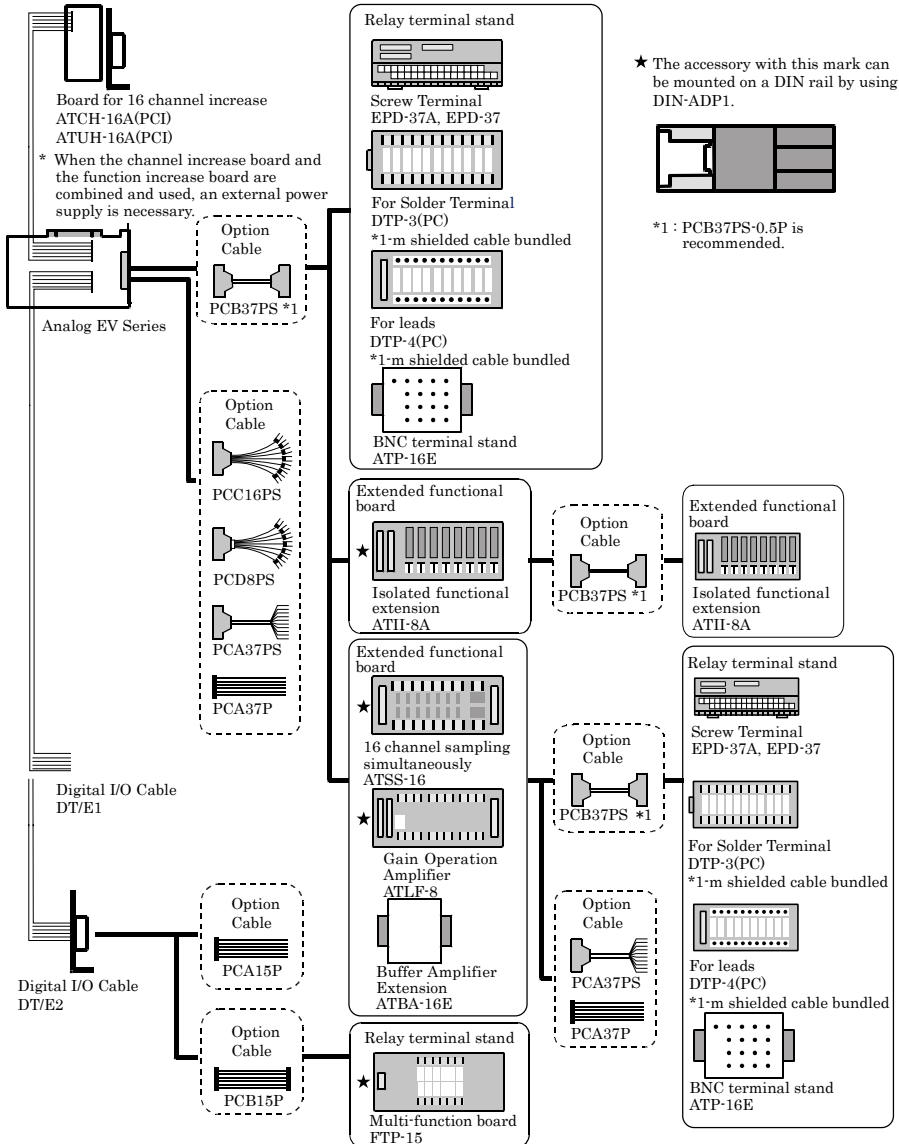
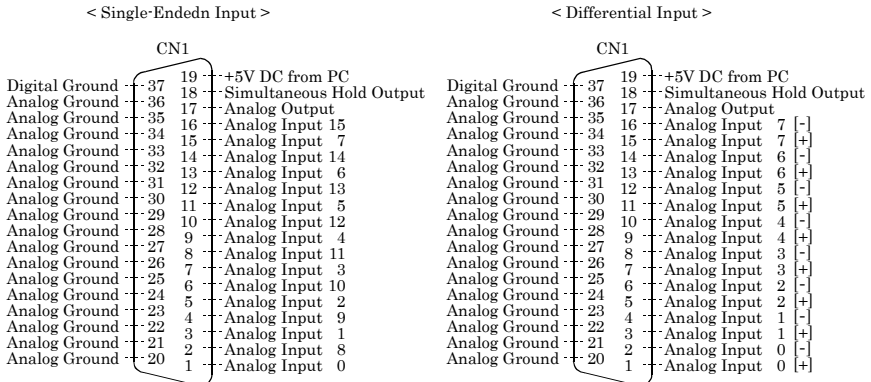

Figure 3.2. Examples of Connecting Options

Connector Pin Assignment

Pin Assignment of CN1



Analog Input 0	Analog input signals in single-ended input mode.
- Analog Input 15	The numbers correspond to channel numbers.
Analog Input 0[+]	Analog input signals in differential input mode.
- Analog Input 7[+]	The numbers correspond to channel numbers.
Analog Input 0[-]	Analog input signals in differential input mode.
- Analog Input 7[-]	The numbers correspond to channel numbers.
Analog Output	Analog output signal
Analog Ground	Analog ground common to analog I/O signals.
Simultaneous Hold Output	Control signal for simultaneous sampling unit ATSS-16 available as an option.
+5V DC from PC	Supplies 2A of current at +5 V.
Digital Ground	Digital ground common to "Simultaneous Hold Output" and "+5V DC from PC".

Figure 3.3. Pin Assignment of CN1



CAUTION

Do not connect any of the outputs and power outputs to the analog or digital ground.
Neither connect outputs to each other. Doing either can result in a fault.

Pin Assignment of CN2

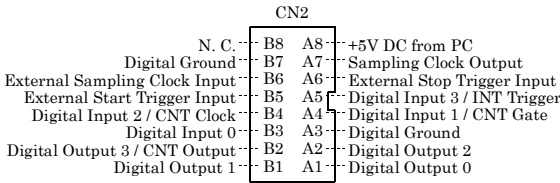

Digital Input 0	Digital input signal.
Digital Input 1 /CNT Gate	Digital input signal. Also serving as the counter gate control input signal.
Digital Input 2 /CNT Clock	Digital input signal. Also serving as the clock input signal
Digital Input 3 /INT Trigger	Digital input signal. Also serving as the interrupt input signal.
Digital Out 0 to Digital Out 2	Digital output signal.
Digital Out 3 to CNT Output	Digital output signal. Capable of being jumper-switched to serve as the counter output signal.
External Start Trigger Input	External trigger input signal for sampling start conditions
External Stop Trigger Input	External trigger input signal for sampling stop conditions
External Sampling Clock Input	External sampling clock input signal
Sampling Clock Output	Sampling clock output signal
+5V DC from PC	Supplies 1A of current at +5 V.
Digital Ground	Digital ground common to the signals and "+5V DC from PC".
N.C.	No connection to this pin.

Figure 3.4. Pin Assignment of CN2

CAUTION

Do not connect any of the outputs and power outputs to the analog or digital ground.
Neither connect outputs to each other. Doing either can result in a fault.

Analog Input Signal Connection

There are two analog input mode: the Single-ended input and the Differential input. Here we give some examples of analog input connections by using flat cable or shield cable.

Single-ended Input

The following figure shows an example of flat cable connection. Each signal source is connected to one analog input channel and the signal common to analog ground pin of CN1.

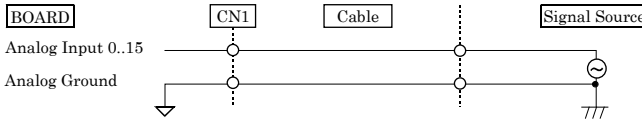

Figure 3.5. Single-ended Input Connection (Flat Cable)

The following figure shows an example of shield cable connection. When the distance between the signal source and the board is long or you want to increase the noise tolerance, a shield cable is suggested. Connect the signal by the core wire and common signal by the shield braids.

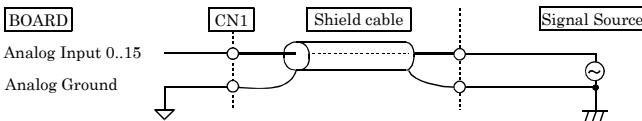

Figure 3.6. Single-ended Input Connection (Shield Cable)



CAUTION

- If the signal source contains over 100kHz (AD12-16(PCI)EV/AD16-16(PCI)EV) or 1MHz (AD12-16U(PCI)EV/AD16-16U(PCI)EV) signals, the signal may effect the cross-talk noise between channels.
- If the board and the signal source receive noise or the distance between the board and the signal source is too long, data may not be input properly.
- An input analog signal should not exceed the maximum input voltage (relate to the board analog ground). If it exceeds the maximum voltage, the board may be damaged.
- Connect all the unused analog input channels to analog ground.

Differential Input

The following figure shows an example of flat cable connection. Each signal source is connected to a [+] pin of analog input channel and the signal common of this source to the [-] pin of this input channel of CN1. In addition, the signal common must be connected to the pin of the analog ground of CN1 by a third wire.

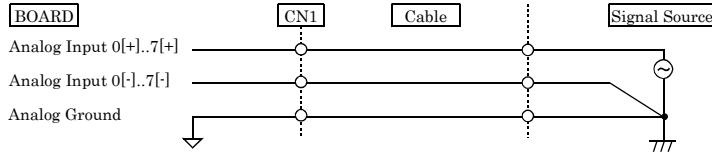

Figure 3.7. Differential Input Connection (Flat Cable)

The following figure shows an example of 2-wire shielded cable connection. When the distance between the signal source and the board is long or you want to increase the noise tolerance, a shield cable connection is preferred. Each signal source is connected to a [+] pin of analog input channel and the signal common of this source to the [-] pin of this input channel of CN1. In addition, the signal common must be connected to the pin of the analog ground of CN1 by the shielded braids.

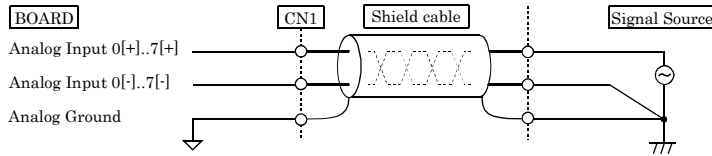

Figure 3.8. Differential Input Connection (Shield Cable)

⚠ CAUTION

- If the signal source contains over 100kHz(AD12-16(PCI)EV/AD16-16(PCI)EV) or 1MHz (AD12-16U(PCI)EV/AD16-16U(PCI)EV) signals, the signal may effect the cross-talk noise between channels.
- The input data would be uncertain if the analog ground is not connected.
- If the board and the signal source receive noise or the distance between the board and the signal source is too long, data may not be input properly.
- The input voltage from the [+] input or [-] input should not exceed the maximum input voltage (based on the board analog ground). If it exceeds the maximum voltage, the board may be damaged.
- Because the input data will be uncertain if the [+] pin or the [-] pin of CN1 is not connected, all the unused input pins of CN1 should be connected to the analog ground, AGND.

Analog Output Signal Connection

This section shows how to connect the analog output signal by using a flat cable or a shielded cable.

The following figure shows an example of flat cable connection.

Connect the signal source and ground to the CN1 analog output.

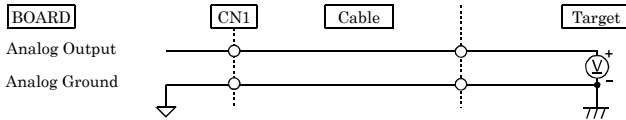

Figure 3.9. Analog Output Connection (Flat Cable)

If the distance between the signal source and the board is long or if you want to increase the noise tolerance, a shield cable connection is strongly recommended.

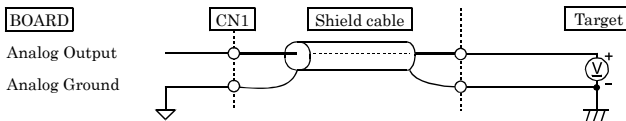

Figure 3.10. Analog Output Connection (Shield Cable)



CAUTION

- If the board or the connected wire receives noise, or the distance between the board and the target is long, data may not be outputted properly.
- For analog output signal, the current capacity is $\pm 5\text{mA}$ (Max.). Check the specification of the connected device before connecting the board.
- Do not short the analog output signal to analog ground, digital ground, and/or power line. Doing so may damage the board.

Digital I/O signals and Control signals Connection

The digital I/O signals and the control signals are interfaced through the connector CN2. User can use an optional cable DT/E1 or DT/E2 (with bracket and a 15-pin D type female connector) to connect these signals to your external devices.

All the digital I/O signals and control signals are TTL level signals.

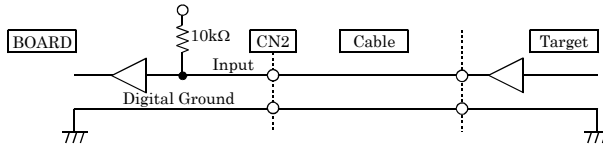

Figure 3.11. Digital Input Connection

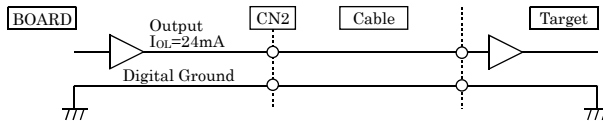

Figure 3.12. Digital Output Connection

⚠ CAUTION

Do not short the output signals to analog ground, digital ground, and/or power line. Doing so may damage the board.

Reference

For the operation timings for control signal input, see "Timing of External Control Signals" in Chapter 6 "Hardware".

4. Functions

This chapter explains the function that can be achieved by hardware and driver's combinations. The driver indicates the thing of API-AIO(WDM) as long as there is no annotation.

Analog Input Function

The board converts analog signals to digital data according to the resolution and stores it in memory. You can set a variety of conditions for analog input, including the input channel, sampling period, and sampling start/stop conditions.

Analog input processes are classified as follows:

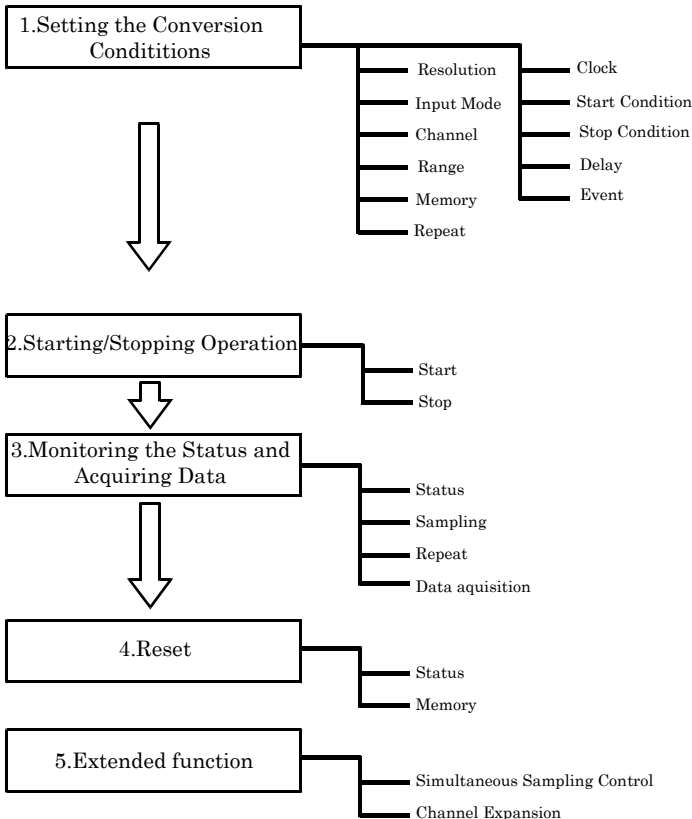

1. Setting the Conversion Conditions

First, set the conditions for executing analog input.

Resolution

”Resolution” signifies the number of bits used by an analog input device to represent analog signals. The higher the resolution, the more finely the voltage range is segmented, allowing the device to convert analog values to digital equivalents more precisely.

A device with a resolution of 12-bit divides the range width into 4096 segments.

When the device covers the range of 0 - 10 V, the minimum unit of converted voltages is $10 \div 4096 \neq 2.44\text{mV}$.

If the device has a resolution of 16-bit, it is $10 \div 65536 \neq 0.153\text{mV}$ instead.

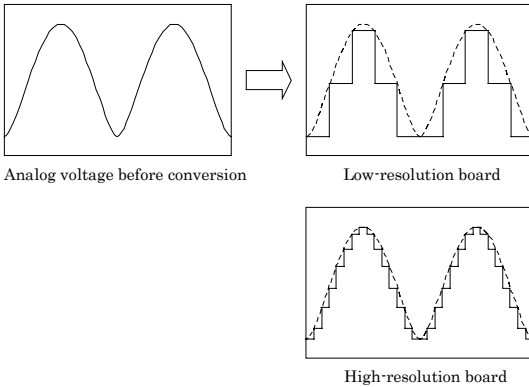

AD12-16(PCI)EV and AD12-16U(PCI)EV : The resolution is 12-bit.

AD16-16(PCI)EV and AD16-16U(PCI)EV : The resolution is 16-bit.

Input Mode

”Input Mode” indicates the method of connecting analog input signals.

The input modes available are single-ended input and differential input.

The single-ended input mode is suitable for the environment in which the potential difference between the signal source and ground and noise components can be ignored. For the environment in which they cannot be ignored, the differential input mode is suitable.

The number of channels available in differential input mode is half that in single-ended input mode.

This board uses on-board jumpers to set the input mode.

For details, see “Chapter 2 Setup- Setting the Hardware - Setting the Analog Input”.

Channel

”Channel” represents each point of analog input.

For individual channel numbers, see “Using the On-board Connectors” to “Connector Pin Assignment” in Chapter 3 “External Connection”.

You can specify an arbitrary number of points of analog input by setting the channels by means of software.

Range

”Range” means the range of voltages at which analog input can be performed.

The input range can be selected by setting the upper and lower input signals.

AD12-16(PCI)EV : The range is specified by setting both jumpers and software.

AD16-16(PCI)EV : The range is specified by setting the jumpers.

AD12-16U(PCI)EV : The range is specified by setting the jumpers.

AD16-16U(PCI)EV : The range is specified by setting the jumpers.

For details, see “Chapter 2 Setup- Setting the Hardware - Setting the Analog Input”.

Memory

Board’s or driver’s input data storage memory is used to enable advanced analog input processing at high speed. For the memory, the FIFO or ring format can be selected by means of software.

- FIFO format

In the FIFO (First In First Out) format, input data items are read from memory in the same order in which they were written to the memory. Input data items are fed out of the memory sequentially, where the oldest one is always read from the memory. The status monitor and application notification functions are provided, which check and report the state in which the memory has stored a fixed amount of data or in which the memory has become full.

The FIFO memory is used to obtain all input data from analog input in a short or infinite period of time.

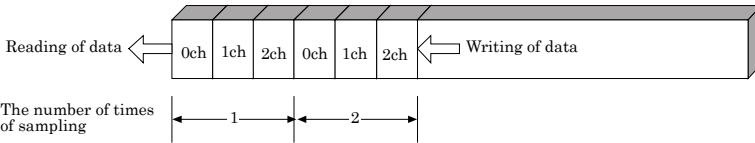

- Ring format

In the ring format, the memory contains storage areas arranged in a ring. Input data items are written to the memory sequentially. When it stores data exceeding the limit, it overwrites the area storing the previous item of input data. The status monitor and application notification functions are provided, which check and report the state in which data has been written to certain areas of memory. The ring memory is used to obtain data where conversion has stopped due to some event, usually without obtaining data in the normal state.

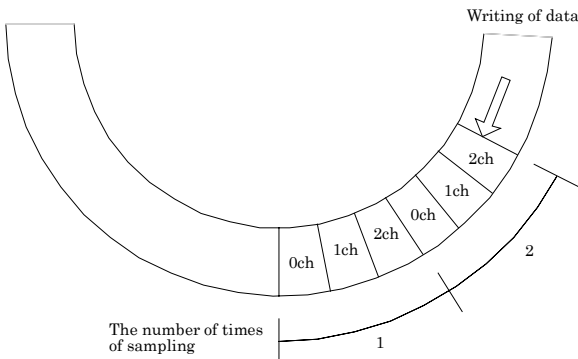

Repeat

”Repeat” indicates the number of repetitions of sampling to be executed, from when the sampling start condition is satisfied until the end of sampling, including delayed sampling.

The number of repetitions is set by means of software, for which conversion is repeated. You can set an infinite number of repetitions, in which case the conversion is terminated by the software abort command. Input data items are stored to the memory sequentially. The repetition state can be subject to status monitoring and application notification.

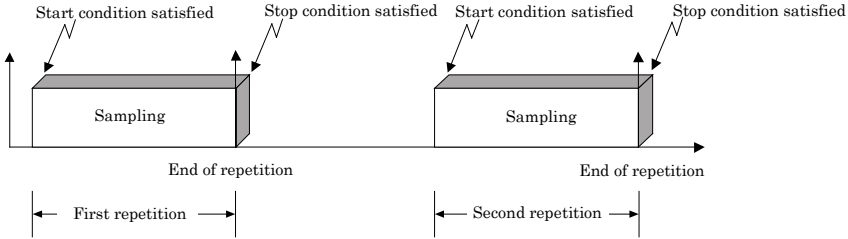

This board does not support the Repeat feature when the sampling start condition is "software".

Clock

The internal or external sampling clock can be selected as the sampling clock that determines the sampling period. The sampling clock is selected by means of software.

- Internal sampling clock
The clock signal from the on-board clock generator is used.
- External sampling clock
The edge of the digital signal input from an external device is used for the sampling clock.

Start Condition

The condition for controlling the start of sampling can be selected from among software, input data comparison, and an external trigger. The conditions for controlling the start and stop of sampling are completely independent of each other; they can be set separately.

- Software

The board starts sampling and storing input data to memory immediately after the operation start command is issued.

- Input data comparison

When the operation start command is issued, the board compares the analog signal input through a specified channel to the value of the preset comparison level. If the analog signal satisfies the condition, the board starts storing input data.

Level comparison conditions are set as two conditions: level and direction.

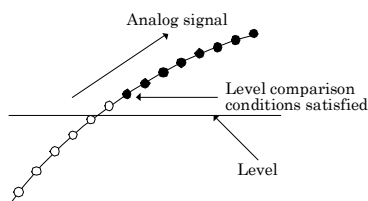

The above sketch shows that the level comparison condition is satisfied in the rising direction.

The start condition is satisfied when the analog signal at the specified channel passes the comparison level in the rising direction. Input data items are stored to memory, starting with those at solid dots.

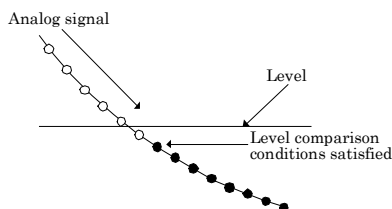

The above sketch shows that the level comparison condition is satisfied in the falling direction.

The start condition is satisfied when the analog signal at the specified channel passes the comparison level in the falling direction. Input data items are stored to memory, starting with those at solid dots.

If you set the level comparison directions to both directions, the start condition is satisfied when the analog signal passes the level both in the rising and falling directions.

- External trigger

The board enters the external control signal wait status immediately after the operation start command is issued.

When the external control signal in the preset edge direction (rising or falling) is input, the board starts sampling and storing input data to memory.

Stop Condition

The condition for controlling the stop of sampling can be selected from among the last sampling count, input data comparison, an external trigger, and software abort.

The board stops sampling whenever an error occurs irrespective of the stop condition setting.

- Last sampling count

The board stops sampling after storing input data to memory for the specified number of times of sampling.

- Input data comparison

Once the board has started sampling, it compares the analog signal input through a specified channel to the value of the preset comparison level. If the analog signal satisfies the condition, the board stops sampling.

Level comparison conditions are set as two conditions: level and direction.

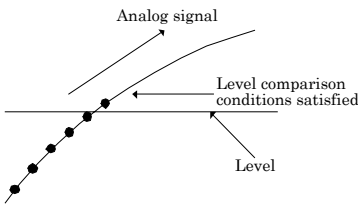

The above sketch shows that the level comparison condition is satisfied in the rising direction.

The stop condition is satisfied when the analog signal at the specified channel passes the comparison level in the rising direction. Input data items are stored to memory, ending until those at solid dots.

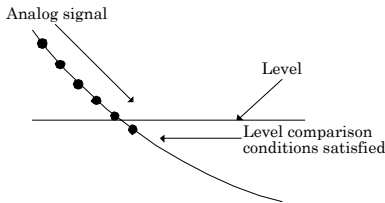

The above sketch shows that the level comparison condition is satisfied in the falling direction.

The stop condition is satisfied when the analog signal at the specified channel passes the comparison level in the falling direction. Input data items are stored to memory, ending until those at solid dots. If you set the level comparison directions to both directions, the start condition is satisfied when the analog signal passes the level both in the rising and falling directions.

- External trigger

The board enters the external control signal wait status upon completion of sampling for the specified number of times. The board stops sampling upon reception of the external control signal in the preset edge direction (rising or falling).

- Software

In this mode, the board continues sampling infinitely until either the software abort command is executed or an error occurs.

Delay

Delayed sampling is performed after the sampling stop condition is satisfied.

When a sampling stop condition other than the software abort command is satisfied, the board performs sampling for the specified number of times of delayed sampling to store input data to memory.

If you set the number of times of delayed sampling to 0, the board stops sampling the moment the sampling stop condition is satisfied.

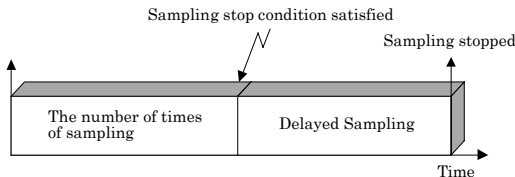

Event

“Event” works as a function for reporting the occurrence of a certain board state to the application.

The following events can be used in combination depending on the specifications and purpose of the application.

- “AD conversion start condition satisfied” event
This event occurs when the AD conversion start condition is satisfied. The event is nullified when the conversion start condition is “software”.
- “Repeat end” event
This even occurs whenever a repetition is completed.
- “End of device operation” event
This event occurs when the entire operation including repetitions is completed.
- “Stored specified sampling times” event
This event occurs when sampling has been performed for the number of times set by software.
- Overflow event
This event occurs at an attempt to store input data with the memory full.
- Sampling clock error event
This event occurs when conversion stops as an error occurs due to a sampling clock period that is too short.
- AD conversion error event
This event occurs when conversion stops due to an AD conversion error.

2. Starting/Stopping Operation

Sampling is started by the software command.

Once started, sampling can be stopped by the software command at any timing.

3. Monitoring the Status and Acquiring Data

Software commands are used to monitor the operation status of the device and to acquire input data from memory. Status monitoring and data acquisition can be performed even during sampling.

Status

The current state of the device can be checked by obtaining the device status.

The following types of device status are available:

- Device operating
The “device operating” status remains ON, after the execution of the sampling start command until the board completes conversion, aborts operation due to an error, or stops sampling in response to the command.
- Waiting for start trigger
This status remains ON, after the board starts sampling until the start trigger is input, if the conversion start condition is an external trigger or level comparison. The status is set to OFF when the input trigger is input to start conversion.
The status is set to ON whenever the board enters the conversion start wait status even when repeated operation has been set.
- Specified sampling data stored
This status is set to ON when input data stored in memory has reached the amount corresponding to the preset number of times of sampling.
If the memory format is FIFO, the status is set to OFF when the amount of input data in the memory falls below the value corresponding to the preset number of times of sampling as data is acquired. Once the status is set to ON when the memory format is ring, it remains ON until it is reset.
- Overflow
An overflow error occurs when an attempt is made to store input data to memory while it has been full of input data.
When the memory format is FIFO, the board stops conversion.
When the memory format is ring, the board continues conversion while overwriting existing data with new one.
- Sampling clock error
This error occurs when the sampling clock period is too short.
- AD conversion error
If the “device operating” status remains ON (without terminating conversion) for an extended period of time, the driver regards that state as an operation error and sets this status to ON. This error stops sampling.

Sampling

The number of sampled items of input data stored in memory can be obtained by the software command.

Repeat

The current repeat count can be obtained by the software command.

Data acquisition

Input data stored in memory can be acquired by the software command.

Illustrated below is the relationship between the number of times of sampling of input data stored in memory and the input channels.

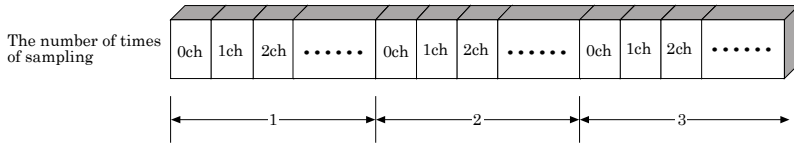

Input data is acquired differently depending on the memory format used.

- Data acquisition in FIFO format

When FIFO memory is used, the oldest data is always read first.

The following sketch shows an image of data acquisition in FIFO format.

When data is acquired from the memory, the free memory space increases by that data size. When data is acquired next, the oldest one of the existing data items is taken from the memory in the same way.

The FIFO memory deletes data once that data is acquired.

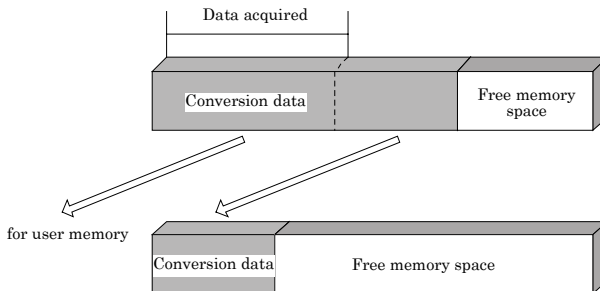

- Data acquisition in ring format

When ring memory is used, data is read always with respect to the current input data write position. The following sketch shows an image of data acquisition in ring format.

The sampling count obtained is always the number of times of sampling for up to the latest data (shaded portion below).

The larger the number of samples taken, the older the data item acquired first.

As the ring memory retains data even after that data is acquired, you can fetch the same data any number of times.

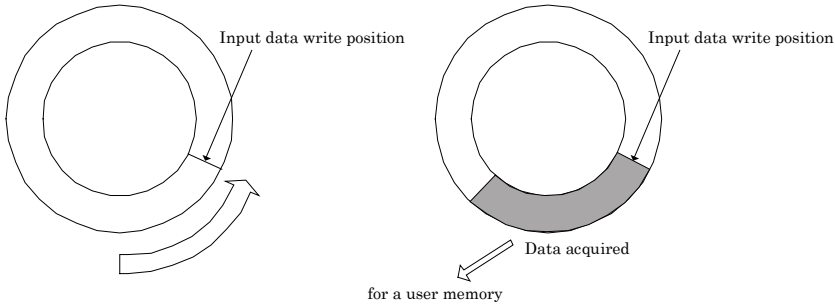

Conversion data

The following equation represents the relationship between input data and voltage.

$$\text{Voltage} = \text{Input data} \times (\text{Max. range value} - \text{Min. range value}) / \text{Resolution} + \text{Min. range value}$$

The value of resolution for the 12-bit device is 4096; that for the 16-bit device is 65536.

The table below shows the relationship between input data and voltage in the ± 10 V range.

Voltage	Conversion data (12-bit)	Voltage	Conversion data (16-bit)
+9.995V	4095	+9.99970V	65535
:	:	:	:
0.005V	2049	0.00030V	32769
0V	2048	0V	32768
-0.005V	2047	-0.00030V	32767
:	:	:	:
-10.000V	0	-10.000V	0

Ex.: When input data 3072 is input at a resolution of 12-bit in the ± 10 -volt range

$$\begin{aligned} \text{Voltage} &= 3072 \times (10 - (-10)) \div 4096 + (-10) \\ &= 5.0 \end{aligned}$$

4. Reset

Various states can be reset by executing the following reset commands:

All reset

This command resets the entire device, thereby initializing the device.

Status

This command resets the sampling clock error status and AD conversion error status.

Memory

This command resets the following memory related states.

- Resets the sampling count to 0.
- Resets the “specified number of samples stored” status to OFF.
- Resets the buffer overflow status to OFF.
- Resets the repeat count to 0.

5. Extended function

Simultaneous Sampling Control

Simultaneous sampling is executing AD conversion on multiple channels at the sampling clock timing.

The simultaneous sampling unit ATSS-16 available as an option provides this board with the 16-channel simultaneous sampling feature.

Channel Expansion

Using the channel expansion sub-board ATCH-16A(PCI) (for AD12-16(PCI)EV and AD16-16(PCI)EV) or ATUH-16A(PCI) (for AD16-16U(PCI)EV and AD12-16U(PCI)EV) increases the maximum number of input channels to 32 (16 channels in differential input mode).

Analog Output Function

The board converts digital data to analog signals according to the resolution.

Resolution

"Resolution" signifies the number of bits used by an analog output device to represent analog signals.

The higher the resolution, the more finely the voltage range is segmented, allowing the device to convert digital values to analog equivalents more precisely.

A device with a resolution of 12-bit divides the range width into 4096 segments.

When the device covers the range of 0 - 10 V, the minimum unit of converted voltages is $10 \div 4096 \approx 2.44\text{mV}$.

If the device has a resolution of 16-bit, it is $10 \div 65536 \approx 0.153\text{mV}$ instead.

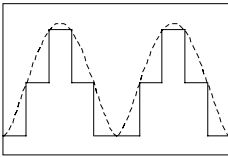

Low-resolution board

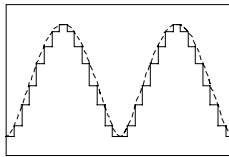

High-resolution board

AD12-16(PCI)EV and AD12-16U(PCI)EV : The resolution is 12-bit.

AD16-16(PCI)EV and AD16-16U(PCI)EV : The resolution is 16-bit.

Channel

"Channel" represents each point of analog output.

For individual channel numbers, see "Using the On-board Connectors" to "Connector Pin Assignment" in Chapter 3 "External Connection".

You can specify an arbitrary number of points of analog output by setting the channels by means of software.

Range

"Range" means the range of voltages at which analog output can be performed.

The input range can be selected by setting the upper and lower output signals.

AD12-16(PCI)EV : The range is specified by setting the jumpers.

AD16-16(PCI)EV : The range is specified by setting the jumpers.

AD12-16U(PCI)EV : The range is specified by setting the jumpers.

AD16-16U(PCI)EV : The range is specified by setting the jumpers.

For details, see "Chapter 2 Setup- Setting the Hardware - Setting the Analog Output".

Output data

Set output data to output analog signals. You can output analog signals to the specified channel or channels (from 0 to an arbitrary number of channels) by executing the software command.

The following equation represents the relationship between output data and voltage.

Output data = ((Voltage - Min. range value) x Resolution) / (Max. range value - Min. range value)

The value of resolution for the 12-bit device is 4096; that for the 16-bit device is 65536.

The table below shows the relationship between output data and voltage in the ± 10 V range.

Voltage	Output data(12-bit)	Voltage	Output data(16-bit)
+9.995V	4095	+9.99970V	65535
:	:	:	:
0.005V	2049	0.00030V	32769
0V	2048	0V	32768
-0.005V	2047	-0.00030V	32767
:	:	:	:
-10.000V	0	-10.000V	0

Ex.: When 3V is output at a resolution of 12-bit in the ± 10 -volt range

$$\begin{aligned} \text{Output data} &= (3 - (-10)) \times 4096 \div (10 - (-10)) \\ &= 2662.4 * \end{aligned}$$

- * The value that can be set as output data at this time is an integer. Select "2662" or "2663" as the output data.

The analog signal corresponding to the output data contains an error as follows:

- Output data "2662" converted to: 2.9980 V
- Output data "2663" converted to: 3.0029 V

This error is a consequential error occurring when output data is obtained from an expected analog value.

Digital Input Function

Input bit

Individual digital input points are called input bits.

When the number of input points of a device is 4, the bits are determined as bit 0 - bit 3.

	bit3	bit2	bit1	bit0
--	------	------	------	------

Input in Bits

The state 1 (ON) or 0 (OFF) of each input bit can be obtained by specifying the bit.

Input in Bytes

Individual input bits can be input in byte units.

When the number of input points of the device is 4, the individual input bits are arranged as shown below and the byte data to be input is a value between 0 and 15 depending on the states of the bits.

EX. Input of bit 3 (OFF), bit 2 (ON), bit 1 (OFF), and bit 0 (ON)

Byte data = 5(5H)

	bit3	bit2	bit1	bit0
	0(OFF)	1(ON)	0(OFF)	1(ON)

Digital Output Function

Output bit

Individual digital output points are called output bits.

When the number of output points of a device is 4, the bits are determined as bit 0 - bit 3.

	bit3	bit2	bit1	bit0
--	------	------	------	------

Output in Bits

The state of each output bit can be changed to ON or OFF by specifying the bit and setting it to 1 or 0.

Output in Bytes

Individual output bits can be output in byte units.

When the number of output points of the device is 4, the individual output bits are arranged as shown below and byte data to be output is a value between 0 and 15.

Ex. Output of bit 3 (ON), bit 2 (OFF), bit 1 (ON), and bit 0 (OFF)

Byte data = 10(AH)

	bit3	bit2	bit1	bit0
	1(ON)	0(OFF)	1(ON)	0(OFF)

Counter Function

The board have been equipped an independent counter that is equivalent to the i8254. The counter has three internal 16-bit counters. These counters are connected as shown in Figure 4.1. Changing the jumper connections can change the counter configurations. The counter can be operated as a programmable one shot pulse or a rate generator by setting the operation mode of i8254. The two counter outputs is set in the board register, and the status (8254 count-up status and 8254 count-overrunning status) can be confirmed by software.

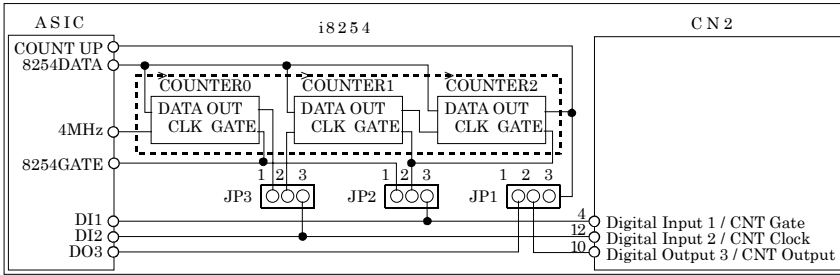
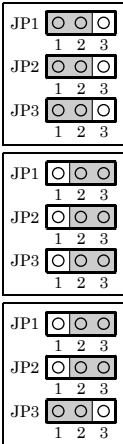

Figure 4.1. Counter Configuration



The following table shows the jumper settings.

This setting connects three counters in the cascade mode. The counter 0 clock is the on board 4MHz clock signal. The 8254GATE gate signal of the counters is controlled by software command.

This setting implements a 32-bit counter (connecting Counter 1 and Counter 2) and enables the user to control the 32-bit counter externally. The clock and the gate can be inputted from CN2, and the counter output signal be outputted from CN2 via JP1.

This setting implements a 32-bit counter (connecting Counter 1 and Counter 2) and enables the user to control only the gate. The clock uses the output of counter 0 on the basis of 4MHz. The gate can be inputted from CN2, and the output signal of the counter be outputted from CN2 via JP1.

⚠ CAUTION

- Only the TTL level signals can be used as an external control signal for the counter.
- Please refer to the data sheet of i8254 equivalent for details of the operation mode of i8254.

5. About Software

CD-ROM Directory Structure

\	
— Autorun.exe	Installer Main Window
Readmej.html	Version information on each driver (Japanese)
Readmeu.html	Version information on each driver (English)
.	
— APIPAC	Each installer
— AIO	
— DISK1	
— DISK2	
—	
— DISKN	
— AioWdm	
— CNT	
— DIO	
—	
.	
— HELP	HELP file
— Aio	
— Cnt	
—	
.	
— INF	Each INF file for OS
— WDM	
— Win2000	
— Win95	
.	
— linux	Linux driver file
— cnt	
— dio	
—	
.	
— Readme	Readme file for each driver
.	
.	
— Release	Driver file on each API-TOOL (For creation of a user-specific install program)
— API_NT	
— API_W95	
.	
.	
— UsersGuide	Hardware User's Guide(PDF files)

About Software for Windows

The bundled CD-ROM “Driver Library API-PAC(W32)” contains the functions that provide the following features:

- Analog input or output through arbitrary channels
- Analog input at arbitrary intervals using the internal or external sampling clock
- Simultaneous monitoring of the termination of analog input sampling, buffer memory usage, and interrupt events such as occurrences of errors
- Driver option check using a demo driver even without the board installed

For details, refer to the help file. The help file provides various items of information such as “Function Reference”, “Sample Programs”, and “FAQs”. Use them for program development and troubleshooting.

When using the API-AIO(WDM)

Accessing the Help File

- (1) Click on the [Start] button on the Windows taskbar.
- (2) From the Start Menu, select “Programs” – “CONTEC API-PAC(W32)” – “AIO(WDM)” – “API-AIO(WDM) HELP” to display help information.

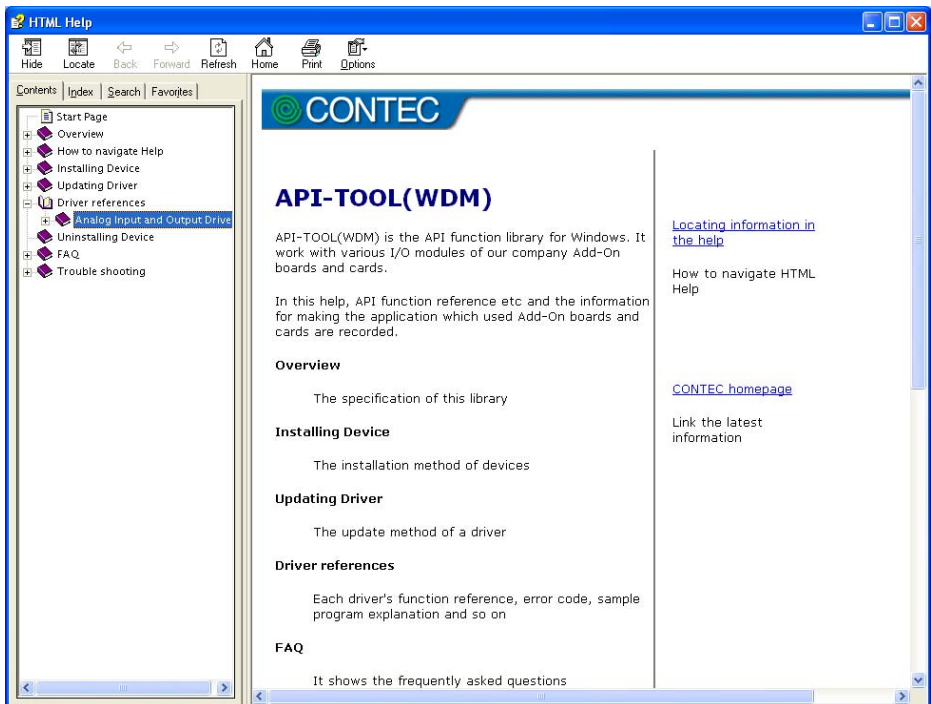

Using Sample Programs

Sample programs are provided for each of the basic operations. You can use these to check the operation of the board and as a reference when writing your own programs.

To use the sample programs, specify the device name in the property page for the program.

The sample programs are stored in \Program Files\CONTEC\API-PAC(W32)\AIOWDM\Samples.

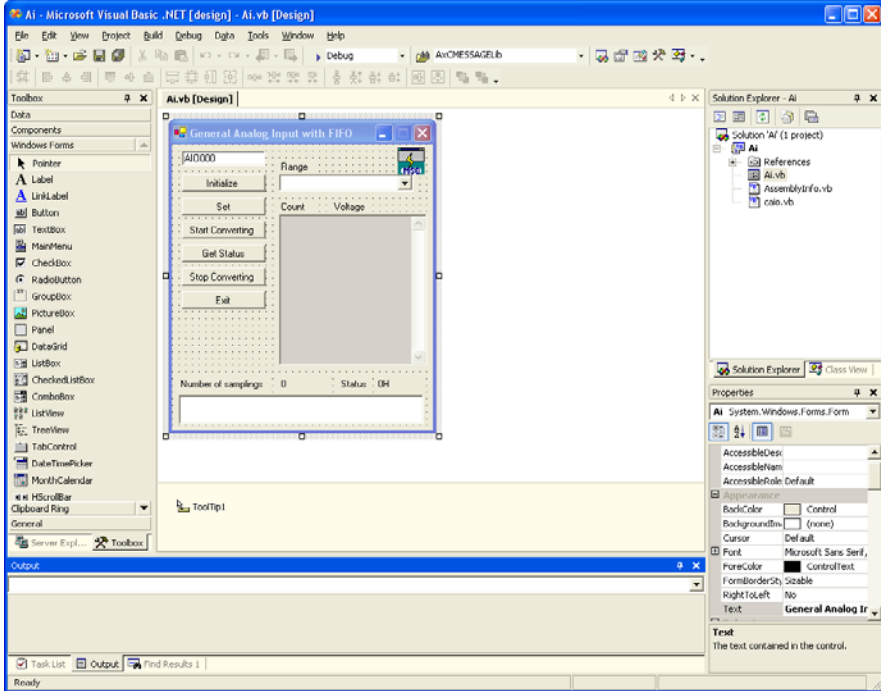

Running a Sample Program

- (1) Click on the [Start] button on the Windows taskbar.
- (2) From the Start Menu, select “Programs” - “CONTEC API-PAC(W32)” - “AIOWDM” - “SAMPLE...”.
- (3) A sample program is invoked.

Sample Programs - Examples

Analog input

Simple sample program

- SingleAi Perform single analog input from specified channel
- MultiAi Perform single analog input from multiple channels
- Ai Perform standard analog input using a FIFO buffer
- AiPoll Perform standard analog input by polling
- AiEx Perform analog input for multiple channels using a FIFO buffer
- AiLong Perform long-duration analog input using a FIFO buffer
- AiExt Perform analog input using an external clock
- AiTrg Perform analog input using an external trigger to start and stop operation
- AiLevel1 Use a level trigger to start analog input
- AiLevel2 Use a level trigger to stop analog input
- Ai2 Perform standard analog input using more than one device

Analog output

- SingleAo Perform single analog output from specified channel
- MultiAo Perform single analog output from multiple channels
- Ao Perform standard analog output using a FIFO buffer
- AoPoll Perform standard analog output by polling
- AoEx Perform analog output for multiple channels using a FIFO buffer
- AoLong Perform long-duration analog output using a FIFO buffer
- AoExt Perform analog output using an external clock
- AoRing Perform continuous analog output using a ring buffer
- AoTrg Perform analog output using an external trigger to start and stop operation
- Ao2 Perform standard analog output using more than one device

Digital input/output

- DioBit Perform digital I/O using bit values
- DioByte Perform digital I/O using byte values

Usage of Utility Program

Program for Measurement of Function Execution Speed

The execution time of some main functions can be measured in a function execution speed measurement program. To use a function execution speed measurement program, click the [execution time measurement] button in the diagnostic program.

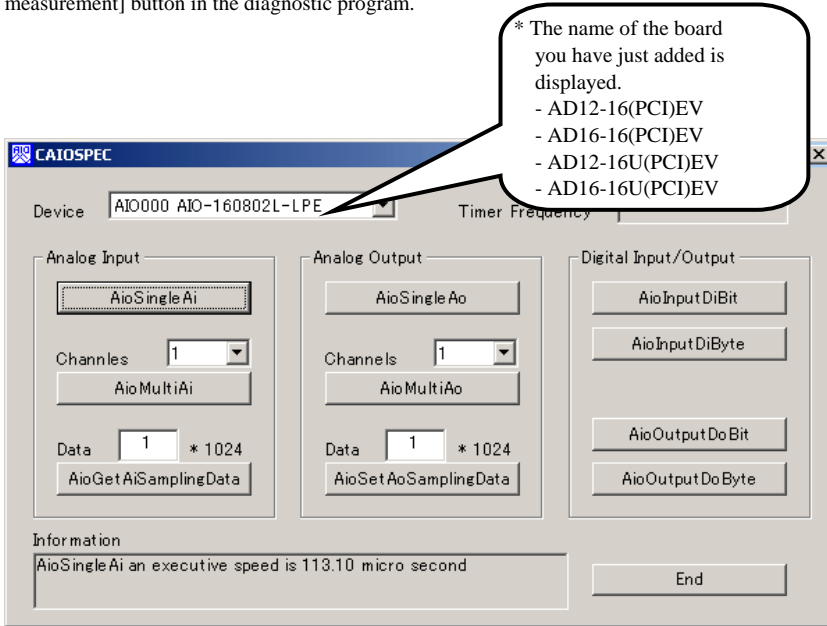

Procedure

- (1) Chose the measure device from device list.
- (2) Click the button written with the function name to measure the execution speed of the function. Please choose from a list the number of channels used for conversion in function AioMultiAi and AioMultiAo. Input the transmission data size in function AioGetAiSamplingData and AioSetAoSamplingData. The transmission data is set by unit of kByte.
- (3) End the application with an [end] button.

Analog Input Measurement Tool

It is an analog input measurement utility to carry out infinity sample in the FIFO memory. Once the conversion data of memory accumulates to a certain quantity, the event occurs and data of the memory is acquired. Data in the FIFO memory can be confirmed visually.

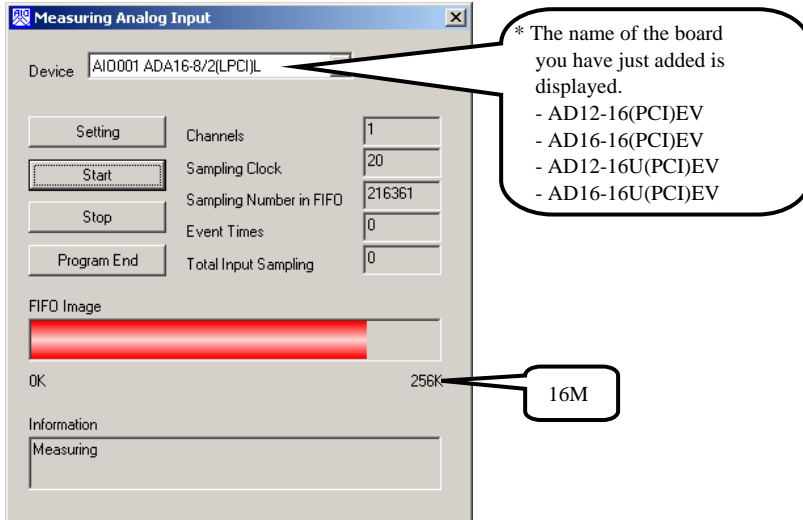

The number of channels used, the internal/external clock, the conversion speed, and the sampling frequency at which an event generates can be set. Since the notification of a sampling clock error event is sent, please make use of it for the conversion spec measurement under various conversion conditions.

Procedure

(1) Chose the device name of the device to be used from the upper left combo box, and click the setting button.

(2) The conversion conditions are set on the screen of the analog input setting.

Once an input is done at the sampling frequency specified as data taking-in sampling, an event occurs and data will be acquired. Click the OK button to finish setting the conditions, and returns to former screen.

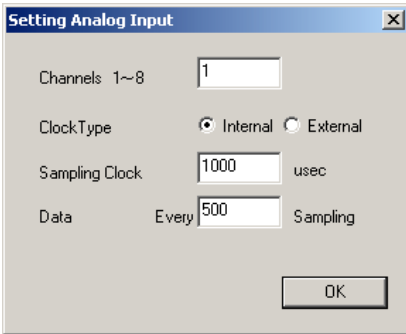

(3) Start the measurement with measurement start button. The various states during the conversion are displayed.

The number of the samplings in FIFO is :

It is conversion data taken in the memory. This can be visually checked in a "memory image".

Event generation sampling frequency :

When the number of input sampling in FIFO reaches this frequency, the event generates.

Total input sampling frequency :

It is the total number of samplings for application in the memory.

Measurement may stop by the following errors.

Sampling clock error :

It means that the conversion speed is too fast and the driver processing is not in time when converting at the internal clock.

The cycle of the clock is too fast when converting it at the external clock. Moreover, the cause by noise etc. is also concerned.

Buffer overflow :

The memory overflows since the conversion speed is too fast compared with the one at which data is inputted.

(4) Click the "stop" button, and measurement stops.

When using the API-AIO(98/PC)

Accessing the Help File

- (1) Click on the [Start] button on the Windows taskbar.
- (2) From the Start Menu, select “Programs” – “CONTEC API-PAC(W32)” – “Aio” – “API-AIO HELP” to display help information.

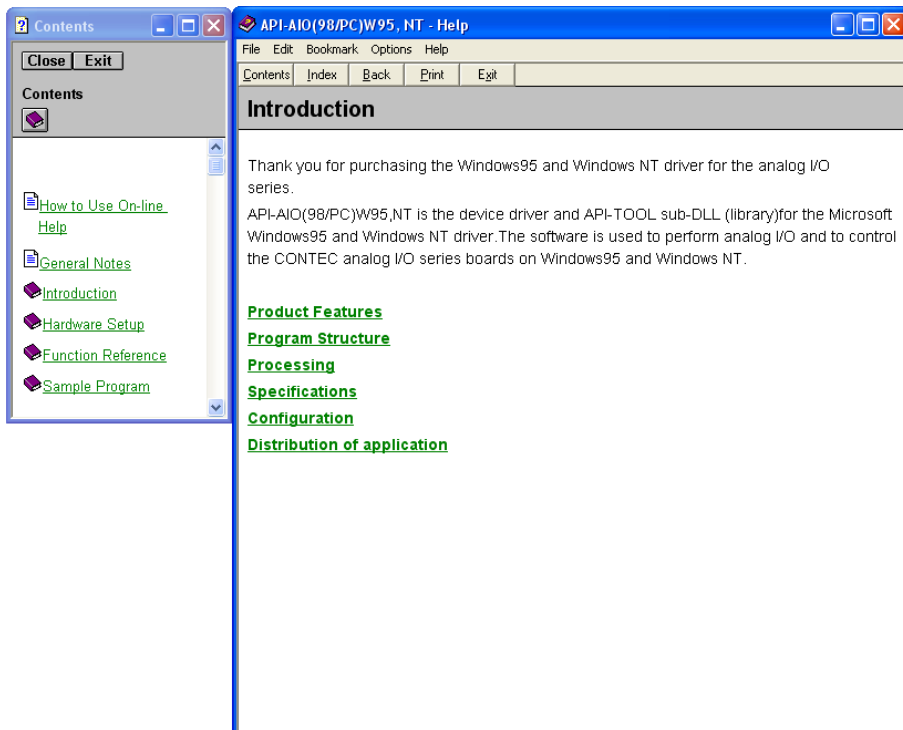

Using Sample Programs

Sample programs have been prepared for specific basic applications.

To use each sample program, enter its device name set by API-TOOL Configuration.

Use these sample programs as references for program development and operation check.

The sample programs are stored in \Program Files\CONTEC\API-PAC(W32)\Aio\Samples.

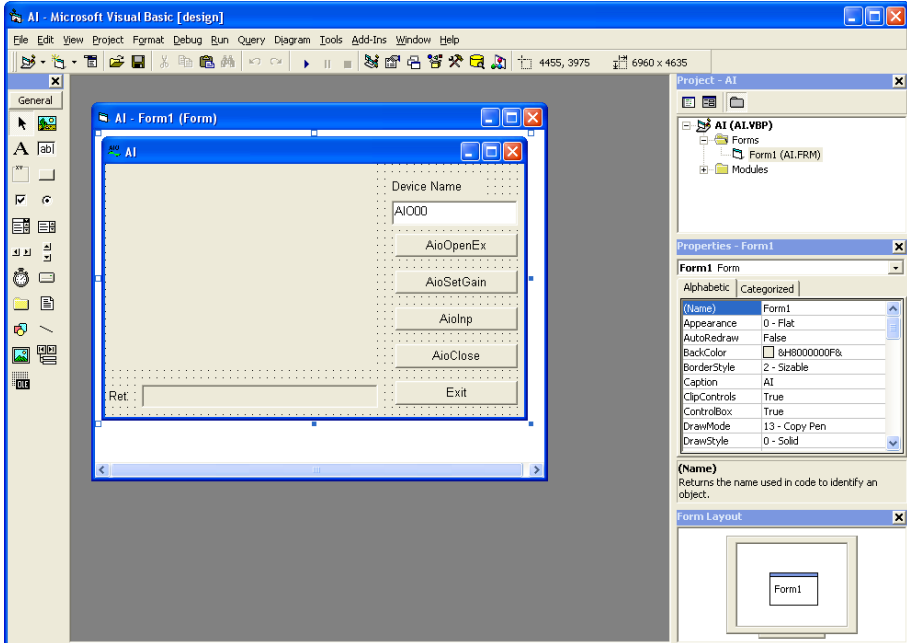

Running a Sample Program

- (1) Click on the [Start] button on the Windows taskbar.
- (2) From the Start Menu, select “Programs” – “CONTEC API-PAC(W32)” – “Aio” – “SAMPLE...”.
- (3) A sample program is invoked.

Sample Programs - Examples

Analog input

- AI : Uses AioInp to convert an analog signal only once and display the data.
- AIBack : Uses AioInpBack to perform memory-less board analog input.
- AIMemory : Uses AioInpBdMem to perform continuous conversion and AioReadBuf to acquire data from board memory (an example of using an external clock).
- AIInt : Infinite sampling example that uses AioInpBdMem for half/full interrupts and AioReadBuf to acquire data at interrupt events.
- AITimer : Infinite sampling example that uses AioInpBdMem to perform continuous conversion and AioReadBuf to acquire data at system timer events.
- AISync : Sample that uses AioInpBdMem and AioDO to perform simultaneous sampling of two memory-mounted boards.
- AioInp : Sample console application that uses AioOpenEx and AioInp.

Analog output

- AO : Uses AioOut to perform analog output once.
- AOBack : Uses AioOutBack to perform analog output at fixed intervals.
- AioOut : Sample console application that uses AioOpenEx and AioOut.

Digital input and output

- DIO : Uses AioDO and AioDI to perform digital input/output.

Counter

- Timer : Sample program using a timer. It uses the counter function to measure the lapse of time.
- Counter : Sample program using a counter. It uses the counter function to count external pulses.

The following sample program in Visual Basic is available.

- ANALOG : Versatile sample program using AioInp, AioInpBack, AioInpBdMem, AioOut, AioOutBack, AioDO, and AioDI

Using the Utility Program

Operation Check Tool

This program is a comprehensive operation check tool that can use all the features of the AioOpen, AioClose, AioSetRangeAioInp, AioInpBack, AioInpBdMem, AioOut, AioOutBack, AioDo, and AioDi functions.

Invoke the tool by selecting the Start Menu – “CONTEC API-PAC(W32)” – “AIO” – “SAMPLE Analog”.

[Main screen]

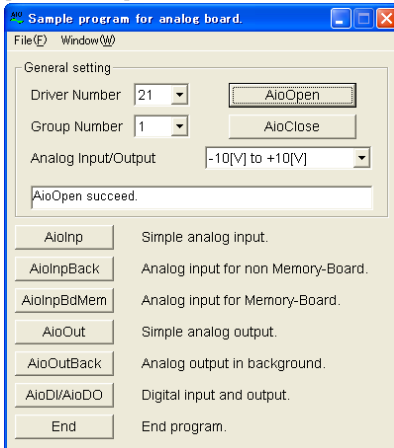

AioInp : Simple analog input

AioInpBack : Analog input for non Memory-Board

AioInpBdMem: Analog input for Memory-Board

AioOut : Simple analog output

AioOutBack : Analog output in background

AioDi/AioDo : Digital input and output

[Analog input]

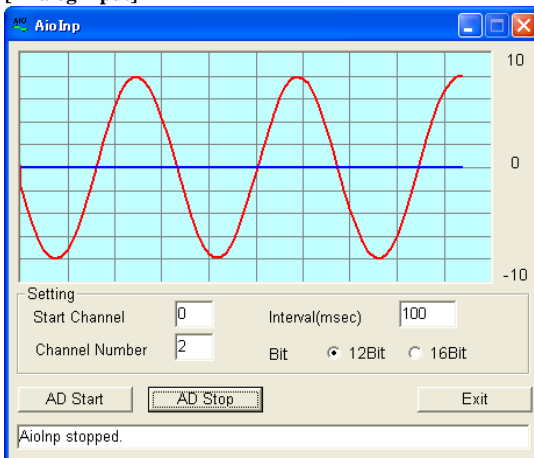

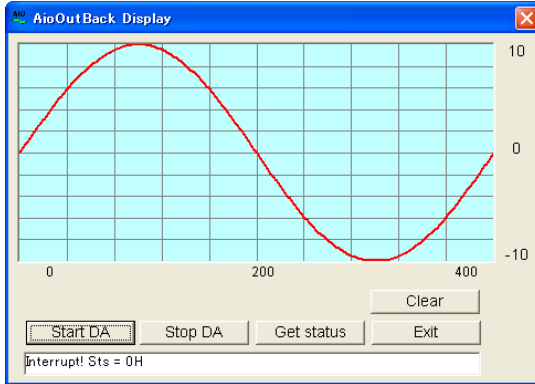
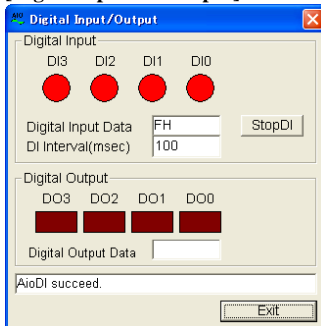
[Analog output]**[Digital input and output]**

Uninstalling the Driver Libraries

To uninstall API-PAC(W32), follow the procedure below.

- (1) Click on the [Start] button on the Windows taskbar. From the Start Menu, select “Settings” – “Control Panel”.
- (2) Double-click on “Add or Remove Programs” in the Control Panel.
- (3) Select "CONTEC API-AIO(WDM) driver" and "CONTEC API-AIO(WDM) VerX.XX (Development environment)" from the list of applications. Click the [Change or Remove Programs] button. Proceed with uninstalling by following the instructions that appear on the screen.

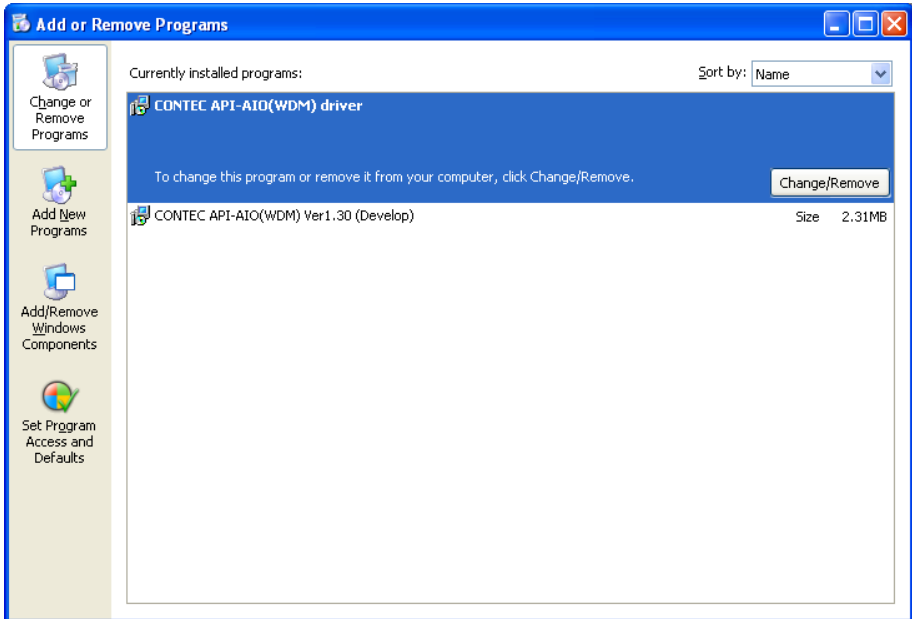

About Software for Linux

The Linux version of analog I/O function driver, API-AIO(LNX), provides functions that execute the following features:

- The analog input/output of a specified channel can be done.
- It is possible to operate as a set parameter to the analog input/output board is preserved by the default value, and the setting of the parameter doesn't exist.

For details, refer to the help file. The help file provides various items of information such as "Function Reference", "Sample Programs", and "FAQs". Use them for program development and troubleshooting.

Driver Software Install Procedure

The Linux version for digital I/O driver, API-AIO(LNX), is supplied as a compressed file /linux/aio/caioXXX.tgz on the bundled API-PAC(W32)CD-ROM. (Note: XXX represents the driver version.)

Mount the CD-ROM as shown below, copy the file to an arbitrary directory, and decompress the file to install the driver.

For details on using the driver, refer to readme.txt and the help file in HTML format extracted by installation.

To install the driver, log in as a superuser.

Decompression and setup procedure

```
# cd
# mount /dev/cdrom /mnt/cdrom           Mount the CD-ROM.
# cp /mnt/cdrom/linux/aio/caioXXX.tgz ./ Copy the compressed file.
# tar xvfz caioXXX.tgz                 Decompress the compressed file.
.....
# cd contec/caio
# make
                                           Compile the file.
.....
# make install                          Install.
.....
# cd config
# ./config                               Set up the board to be used.
..... Set as follows.....
# ./contec_aio_start.sh                 Start the driver.
# cd
```

Accessing the Help File

- (1) Invoke a web browser in your X-Window environment.
- (2) In the browser, open diohelp.htm in the contec/caio/help directory.

Using Sample Programs

Sample programs have been prepared for specific basic applications.

Sample programs for each language are contained in the contec/caio/samples directory. For compiling them, refer to the manual for the desired language.

Uninstalling the driver

To uninstall the driver, use the uninstall shell script contained in the contec/caio directory. For details, check the contents of the script.

6. About Hardware

This chapter provides hardware specifications and hardware-related supplementary information.

For detailed technical information

For further detailed technical information (“Technical Reference” including the information such as an I/O map, configuration register, etc.), visit the Contec's web site (<http://www.contec.com/support/>) to call for it.

Hardware specification

AD12-16(PCI)EV

Table 6.1. Specification < 1 / 2 >

Item	Specification
Analog input	
Isolated specification	Un-Isolated
Type	Single-Ended Input or Differential Input (Jumper setup)
Number of input channels	16ch (Single-Ended Input) 8ch (Differential Input)
Input range	Bipolar $\pm 10V$ Unipolar $0 \sim +10V$ (Set the input range using both of jumpers and software.)
Input gain	x 1, x 2, x 4, x 8
Absolute max. input voltage	$\pm 20V$
Input impedance	1M Ω or more
Resolution	12-bit
Non-Linearity error *1*2	$\pm 2LSB$ (When using the input gain x 1, x 2) $\pm 4LSB$ (When using the input gain x 4, x 8)
Conversion speed	10 μ sec/ch (Max.)
Buffer memory	16M Word FIFO or 16M Word RING (Software setup)
Conversion start trigger	Software/Input data comparison/TTL level external signal
Conversion stop trigger	Specified sampling data stored /Input data comparison/ TTL level external signal/Software
Analog output	
Isolated specification	Un-Isolated
Number of output channels	1ch
Output range	Bipolar $\pm 10V$ / Bipolar $\pm 5V$ / Unipolar $0 \sim +10V$ (Jumper setup)
Output current ability	$\pm 5mA$
Output impedance	1 Ω or less
Resolution	12-bit
Non-Linearity error *1	$\pm 1/2LSB$
Conversion speed	6 μ sec/ch (Max.)
Digital I/O	
Number of input channels	Un-Isolated input 4ch (TTL, Selection of a counter output is possible at a jumper.)
Number of output channels	Un-Isolated input 4ch (TTL, A counter control input and common use are possible at a jumper.)
Counter	
Counter device	i8254 equivalent
Counter clock	Internal (4MHz) or External signal

Table 6.1. Specification < 2 / 2 >

Item	Specification
I/O address	Any 32-byte boundary
Interrupt level	1 level use
Power consumption *3	+5V 1000 mA (Max.)
Operating condition	0 - 50°C, 10 - 90%RH (No condensation)
PCI bus specification	32-bit, 33MHz, Universal key shapes supported *4
Dimension (mm)	176.41(L) x 105.68(H)
Interface connectors	
CN1	D-SUB 37-Pin female connector #4-40UNC
CN2	16-pin Pin-header
Weight	150g

*1: When the environment temperature is near 0°C or 50°C, the non-linearity error may become larger.

*2: At the time of the source use of a signal which built in the high-speed operational amplifier.

*3: If an external device requires this AD12-16(PCI)EV board to supply +5VDC from the CN1 or CN2 connectors, the power consumption of this board will be bigger than what this specification has defined.

*4: This board requires +5V power supply from expansion slots (it does not operate in the environment of only +3.3V power supply).

Board Dimensions

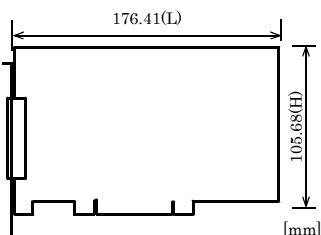

The standard outside dimension (L) is the distance from the end of the board to the outer surface of the slot cover.

AD16-16(PCI)EV

Table 6.2. Specification < 1 / 2 >

Item	Specification
Analog input	
Isolated specification	Un-Isolated
Type	Single-Ended Input or Differential Input (Jumper setup)
Number of input channels	16ch (Single-Ended Input) 8ch (Differential Input)
Input range	Bipolar $\pm 10V$, $\pm 5V$ or Unipolar $0 \sim +10V$, $0 \sim +5V$ (Jumper setup)
Absolute max. input voltage	$\pm 20V$
Input impedance	$1M\Omega$ or more
Resolution	16-bit
Non-Linearity error *1*2*3	$\pm 5LSB$
Conversion speed	10μ sec/ch (Max.)
Buffer memory	16M Word FIFO or 16M Word RING (Software setup)
Conversion start trigger	Software/Input data comparison/TTL level external signal
Conversion stop trigger	Specified sampling data stored /Input data comparison/ TTL level external signal/Software
Analog output	
Isolated specification	Un-Isolated
Number of output channel	1ch
Output range	Bipolar $\pm 10V$ / Unipolar $0 \sim +10V$ (Jumper setup)
Output current ability	$\pm 5mA$
Output impedance	1Ω or less
Resolution	16-bit
Non-Linearity error *1	$\pm 3LSB$
Conversion speed	10μ sec/ch (Max.)
Digital I/O	
Number of input channels	Un-Isolated input 4ch (TTL, Selection of a counter output is possible at a jumper.)
Number of output channels	Un-Isolated input 4ch (TTL, A counter control input and common use are possible at a jumper.)
Counter	
Counter device	i8254 equivalent
Counter clock	Internal (4MHz) or External signal

Table 6.2. Specification < 2 / 2 >

Item	Specification
I/O address	Any 32-byte boundary
Interrupt	1 level use
Power consumption *4	+5V 1000 mA (Max.)
Operating condition	0 - 50°C, 10 - 90%RH (No condensation)
PCI bus specification	32-bit, 33MHz, Universal key shapes supported *5
Dimension (mm)	176.41(L) x 105.68(H)
Interface connectors	
CN1	D-SUB 37-Pin female connector #4-40UNC
CN2	16-pin Pin-header
Weight	150g

- *1: When the environment temperature is near 0°C or 50°C, the non-linearity error may become larger.
- *2: At the time of the source use of a signal which built in the high-speed operational amplifier.
- *3: An error of about 0.02% of the maximum range value may occur with an un-isolated bipolar setting of ± 5 V or an un-isolated unipolar setting of 0 - +5 V.
- *4: If an external device requires this AD16-16(PCI)EV board to supply +5VDC from the CN1 or CN2 connectors, the power consumption of this board will be bigger than what this specification has defined.
- *5: This board requires +5V power supply from expansion slots (it does not operate in the environment of only +3.3V power supply).

Board Dimensions

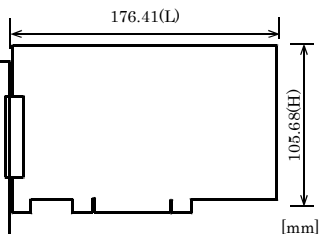

The standard outside dimension (L) is the distance from the end of the board to the outer surface of the slot cover.

AD12-16U(PCI)EV

Table 6.3. Specification < 1 / 2 >

Item	Specification
Analog input	
Isolated specification	Un-Isolated
Type	Single-Ended Input or Differential Input (Jumper setup)
Number of input channels	16ch (Single-Ended Input) 8ch (Differential Input)
Input range	Bipolar $\pm 10V$, $\pm 5V$, $\pm 2.5V$ or Unipolar $0 \sim +5V$, $0 \sim +10V$ (Jumper setup)
Absolute max. input voltage	$\pm 15V$
Input impedance	$1M\Omega$ or more
Resolution	12-bit
Non-Linearity error *1*2	$\pm 3LSB$
Conversion speed	1μ sec/ch (Max.)
Buffer memory	16M Word FIFO or 16M Word RING (Software setup)
Conversion start trigger	Software/Input data comparison/TTL level external signal
Conversion stop trigger	Specified sampling data stored /Input data comparison/ TTL level external signal/Software
Analog output	
Isolated specification	Un-Isolated
Number of output channel	1ch
Output range	Bipolar $\pm 10V$ / Bipolar $\pm 5V$ / Unipolar $0 \sim +10V$ (Jumper setup)
Output current ability	$\pm 5mA$
Output impedance	1Ω or less
Resolution	12-bit
Non-Linearity error *1	$\pm 1/2LSB$
Conversion speed	6μ sec/ch (Max.)
Digital I/O	
Number of input channels	Un-Isolated input 4ch (TTL, Selection of a counter output is possible at a jumper.)
Number of output channels	Un-Isolated input 4ch (TTL, A counter control input and common use are possible at a jumper.)
Counter	
Counter device	i8254 equivalent
Counter clock	Internal (4MHz) or External signal

Table 6.3. Specification < 2 / 2 >

Item	Specification
I/O address	Any 32-byte boundary
Interrupt	1 level use
Power consumption *3	+5V 1000 mA (Max.)
Operating condition	0 - 50°C, 10 - 90%RH (No condensation)
PCI bus specification	32-bit, 33MHz, Universal key shapes supported *4
Dimension (mm)	176.41(L) x 105.68(H)
Interface connectors	
CN1	D-SUB 37-Pin female connector #4-40UNC
CN2	16-pin Pin-header
Weight	150g

*1: When the environment temperature is near 0°C or 50°C, the non-linearity error may become larger.

*2: At the time of the source use of a signal which built in the high-speed operational amplifier.

*3: If an external device requires this AD12-16U(PCI)EV board to supply +5VDC from the CN1 or CN2 connectors, the power consumption of this board will be bigger than what this specification has defined.

*4: This board requires +5V power supply from expansion slots (it does not operate in the environment of only +3.3V power supply).

Board Dimensions

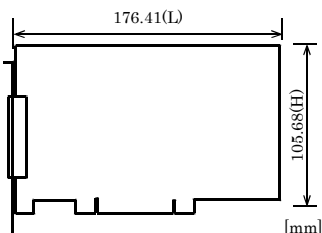

The standard outside dimension (L) is the distance from the end of the board to the outer surface of the slot cover.

AD16-16U(PCI)EV

Table 6.4. Specification < 1 / 2 >

Item	Specification
Analog input	
Isolated specification	Un-Isolated
Type	Single-Ended Input or Differential Input (Jumper setup)
Number of input channels	16ch (Single-Ended Input) 8ch (Differential Input)
Input range	Bipolar $\pm 10V$, $\pm 5V$ or Unipolar $0 \sim +10V$, $0 \sim +5V$ (Jumper setup)
Absolute max. input voltage	$\pm 15V$
Input impedance	1M Ω or more
Resolution	16-bit
Non-Linearity error *1	$\pm 3LSB$
Conversion speed	1 μ sec/ch (Max.)
Buffer memory	16M Word FIFO or 16M Word RING (Software setup)
Conversion start trigger	Software/Input data comparison/TTL level external signal
Conversion stop trigger	Specified sampling data stored /Input data comparison/ TTL level external signal/Software
Analog output	
Isolated specification	Un-Isolated
Number of output channel	1ch
Output range	Bipolar $\pm 10V$ / Unipolar $0 \sim +10V$ (Jumper setup)
Output current ability	$\pm 5mA$
Output impedance	1 Ω or less
Resolution	16-bit
Non-Linearity error *1	$\pm 3LSB$
Conversion speed	10 μ sec/ch (Max.)
Digital I/O	
Number of input channels	Un-Isolated input 4ch (TTL, Selection of a counter output is possible at a jumper.)
Number of output channels	Un-Isolated input 4ch (TTL, A counter control input and common use are possible at a jumper.)
Counter	
Counter device	i8254 equivalent
Counter clock	Internal (4MHz) or External signal

Table 6.4. Specification < 2 / 2 >

Item	Specification
I/O address	Any 32-byte boundary
Interrupt	1 level use
Power consumption *4	+5V 1000 mA (Max.)
Operating condition	0 - 50°C, 10 - 90%RH (No condensation)
PCI bus specification	32-bit, 33MHz, Universal key shapes supported *5
Dimension (mm)	176.41(L) x 105.68(H)
Interface connectors	
CN1	D-SUB 37-Pin female connector #4-40UNC
CN2	16-pin Pin-header
Weight	150g

- *1: When the environment temperature is near 0°C or 50°C, the non-linearity error may become larger.
- *2: At the time of the source use of a signal which built in the high-speed operational amplifier.
- *3: An error of about 0.02% of the maximum range value may occur with an un-isolated bipolar setting of ± 5 V or an un-isolated unipolar setting of 0 - +5 V.
- *4: If an external device requires this AD16-16U(PCDEV board to supply +5VDC from the CN1 or CN2 connectors, the power consumption of this board will be bigger than what this specification has defined.
- *5: This board requires +5V power supply from expansion slots (it does not operate in the environment of only +3.3V power supply).

Board Dimensions

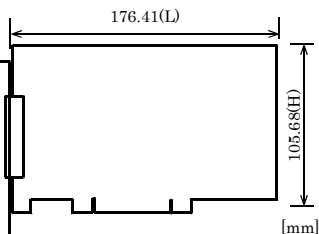

The standard outside dimension (L) is the distance from the end of the board to the outer surface of the slot cover.

Block Diagram

Figure 6.1 is a circuit block diagram of this board.

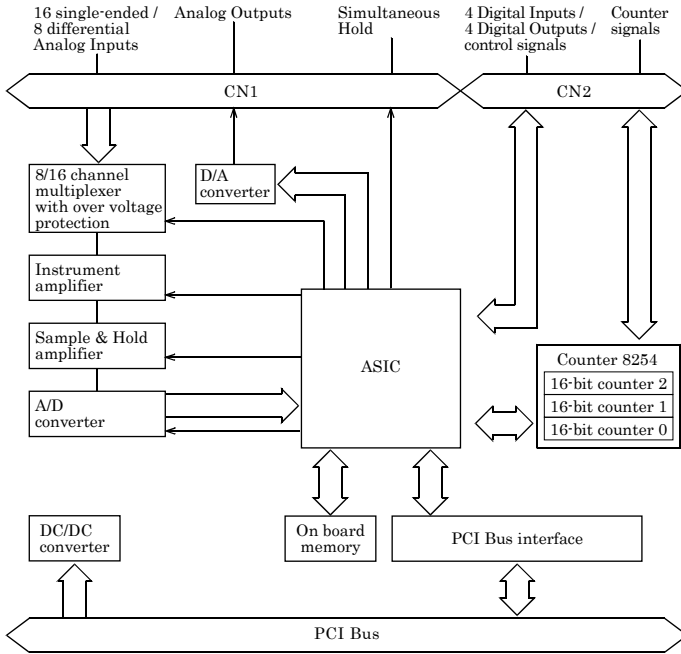

Figure 6.1. Block Diagram

Timing of Sampling Control Signals

There are timing chart diagrams and a table about sampling control signals as shown Fig.6.2 - 6.4 and Table 6.5.

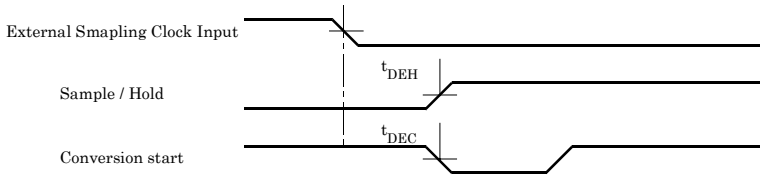

Figure 6.2. Timing Chart of External Sampling Clock

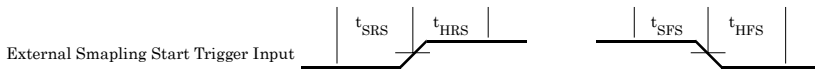

Figure 6.3. Timing Chart of External Sampling Start Trigger

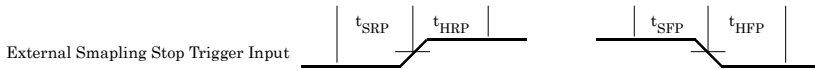

Figure 6.4. Timing Chart of External Sampling Stop Trigger

Table 6.5. Timing Table of External Control Signals

Parameter	Symbol	Typ.	Unit
Delay time from external sampling clock to first hold action	tDEH	100	nsec
Delay time from external sampling clock to first A/D start pulse	tDEC	100	nsec
Set up time of sampling start (Rising edge)	tSRS	100	nsec
Hold time of sampling start (Rising edge)	tHRS	100	nsec
Set up time of sampling start (Falling edge)	tSFS	100	nsec
Hold time of sampling start (Falling edge)	tHFS	100	nsec
Set up time of sampling stop (Rising edge)	tSRP	100	nsec
Hold time of sampling stop (Rising edge)	tHRP	100	nsec
Set up time of sampling stop (Falling edge)	tSFP	100	nsec
Hold time of sampling stop (Falling edge)	tHFP	100	nsec



CAUTION

All the model values are shown at the time of Table 6.5.

About Calibration

This board is calibrated before shipment.

Contact your retailer if the board does not provide its prescribed performance.

Differences between past analog E and this product

This product is a product that partially improves a past analog E series, and the upper compatibility goods of the analog E series. Therefore, the same usage as the E series can be basically done.

There are some differences in specifications as shown below.

Past E Series : AD12-16(PCI)E, AD16-16(PCI)E, AD12-16U(PCI)EH, AD16-16U(PCI)EH
 This product : AD12-16(PCI)EV, AD16-16(PCI)EV, AD12-16U(PCI)EV, AD16-16U(PCI)EV

AD12-16(PCI)EV and AD12-16(PCI)E

	AD12-16(PC)E	AD12-16(PC)EV
I/O address	Any 16-byte boundary	Any 32-byte boundary
Analog input range	Jumper setting	Jumper setting (The setting different from old goods)
Analog output range	Jumper setting	Jumper setting (The setting different from old goods)
Buffer memory	256K Word FIFO or 256K Word RING	16M Word FIFO or 16M Word RING *1
Power consumption	+5V 1100mA (Max.)	+5V 1000 mA (Max.)
Interrupt signal resource setting	Set to select whether to use jumper JP12	Automatically set by PC
PCI bus specification	32-bit, 33MHz, 5V key shapes supported	32-bit, 33MHz, Universal key shapes supported
Dimension (mm)	176.41(L) x 106.68(H)	176.41(L) x 105.68(H)

*1 It is necessary to correct the application because the capacity of the buffer memory is different when replacing it from old goods.

AD16-16(PCI)EV and AD16-16(PCI)E

	AD16-16(PC)E	AD16-16(PC)EV
I/O address	Any 16-byte boundary	Any 32-byte boundary
Analog input range	Jumper setting	Jumper setting (The setting different from old goods)
Analog output range	Jumper setting	Jumper setting (The setting different from old goods)
Buffer memory *1	256K Word FIFO or 256K Word RING	16M Word FIFO or 16M Word RING *1
Analog output non-linearity error	±2LSB	±3LSB
Power consumption	+5V 1100mA (Max.)	+5V 1000 mA (Max.)
Interrupt signal resource setting	Set to select whether to use jumper JP12	Automatically set by PC
PCI bus specification	32-bit, 33MHz, 5V key shapes supported	32-bit, 33MHz, Universal key shapes supported
Dimension (mm)	176.41(L) x 106.68(H)	176.41(L) x 105.68(H)

*1 It is necessary to correct the application because the capacity of the buffer memory is different when replacing it from old goods.

AD12-16U(PCI)EV and AD12-16U(PCI)EH

	AD12-16U(PC)EH	AD12-16U(PC)EV
Power consumption	+5V 1200mA (Max.)	+5V 1000 mA (Max.)
Dimension (mm)	176.41(L) x 106.68(H)	176.41(L) x 105.68(H)

AD16-16U(PCI)EV and AD16-16U(PCI)EH

	AD16-16U(PC)EH	AD16-16U(PC)EV
Power consumption	+5V 1400mA (Max.)	+5V 1000 mA (Max.)
Dimension (mm)	176.41(L) x 106.68(H)	176.41(L) x 105.68(H)

AD12-16(PCI)EV
AD16-16(PCI)EV
AD12-16U(PCI)EV
AD16-16U(PCI)EV
User's Guide

CONTEC CO., LTD.

July 2006 Edition

3-9-31, Himesato, Nishiyodogawa-ku, Osaka 555-0025, Japan

Japanese <http://www.contec.co.jp/>

English <http://www.contec.com/>

Chinese <http://www.contec.com.cn/>

No part of this document may be copied or reproduced in any form by any means without prior written consent of CONTEC CO., LTD. [07052006]

[10122005]

Management No. A-51-065

[07052006_rev2]

Parts No. LYFB451