

PC-HELPER

Digital I/O Board  
with Opto-Isolation for PCI

**PIO-32/32H(PCI)H**

User's Guide

CONTEC CO.,LTD.

---

# Check Your Package

---

Thank you for purchasing the CONTEC product.

The product consists of the items listed below.

Check, with the following list, that your package is complete. If you discover damaged or missing items, contact your retailer.

## Product Configuration List

- Board [PIO-32/32H(PCI)H] ...1
  - First step guide ... 1
  - CD-ROM \*1 [API-PAC(W32)] ...1
- \*1 The CD-ROM contains the driver software and User's Guide (this guide)

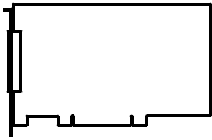

Board

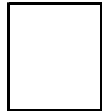

First step guide

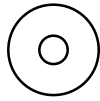

CD-ROM  
[API-PAC(W32)]

---

# Copyright

Copyright 2004 CONTEC CO., LTD. ALL RIGHTS RESERVED

No part of this document may be copied or reproduced in any form by any means without prior written consent of CONTEC CO., LTD.

CONTEC CO., LTD. makes no commitment to update or keep current the information contained in this document. The information in this document is subject to change without notice.

All relevant issues have been considered in the preparation of this document. Should you notice an omission or any questionable item in this document, please feel free to notify CONTEC CO., LTD.

Regardless of the foregoing statement, CONTEC assumes no responsibility for any errors that may appear in this document or for results obtained by the user as a result of using this product.

# Trademarks

MS, Microsoft, Windows, Windows NT and MS-DOS are trademarks of Microsoft Corporation. Other brand and product names are trademarks of their respective holder.

# Table of Contents

Check Your Package .....	i
Copyright .....	ii
Trademarks.....	ii
Table of Contents .....	iii

<b>1. BEFORE USING THE PRODUCT</b>	<b>1</b>
------------------------------------	----------

About the Board .....	1
Features .....	1
Support Software.....	2
Cable & Connector (Option).....	3
Accessories (Option).....	4
Customer Support.....	5
Web Site.....	5
Limited Three-Years Warranty .....	5
How to Obtain Service .....	5
Liability.....	5
Safety Precautions.....	6
Safety Information .....	6
Handling Precautions .....	7
Environment.....	8
Inspection .....	8
Storage .....	8
Disposal.....	8

<b>2. SETUP</b>	<b>9</b>
-----------------	----------

What is Setup?.....	9
Using the Board under Windows Using the Driver Library API-PAC(W32).....	9
Using the Board under Windows Using Software Other than the Driver Library API-PAC(W32).....	9
Using the Board under an OS Other than Windows.....	10
Step 1 Installing the Software .....	11
Starting the Install Program.....	11
Selecting the Digital I/O Driver .....	12
Executing the Installation.....	13
Step 2 Setting the Hardware.....	14
Parts of the Board and Factory Defaults .....	14
Setting the Board ID.....	15
Plugging the Board.....	16

Step 3 Installing the Hardware.....	17
Turning on the PC .....	17
Setting with the Found New Hardware Wizard.....	17
Step 4 Initializing the Software.....	20
Invoking API-TOOL Configuration.....	20
Updating the Settings .....	20
Step 5 Checking Operations with the Diagnosis Program .....	21
What is the Diagnosis Program? .....	21
Check Method .....	21
Using the Diagnosis Program .....	22
Setup Troubleshooting .....	25
Symptoms and Actions.....	25
If your problem cannot be resolved.....	25

<b>3.</b>	<b>EXTERNAL CONNECTION</b>	<b>27</b>
-----------	----------------------------	-----------

Using the On-board Connectors .....	27
Connecting a Device to a Connector .....	27
Connector Pin Assignment .....	28
Relationships between API-PAC(W32) Logical Ports/Bits and Connector Signal Pins.....	29
Connecting Input Signals .....	30
Input Circuit .....	30
Connecting a Switch.....	30
Connecting Output Signals.....	31
Output Circuit.....	31
Connection to the LED.....	32
Example of Connection to TTL Level Input .....	32
Connecting the Sink Type Output and Sink Output Support Input.....	33

<b>4.</b>	<b>FUNCTION</b>	<b>35</b>
-----------	-----------------	-----------

Data I/O Function.....	35
Data Input.....	35
Data Output .....	35
Monitoring Output Data .....	35
Digital Filter .....	36
Digital Filter Function Principle.....	36
Set Digital Filter Time.....	36
Interrupt Control Function .....	37
Disabling/enabling Interrupts .....	37
Selecting the Interrupt Edge .....	37
Clearing the Interrupt Status and Interrupt Signal.....	38

---

5.	ABOUT SOFTWARE	39
----	----------------	----

CD-ROM Directory Structure .....	39
About Software for Windows .....	40
Accessing the Help File.....	40
Using Sample Programs .....	41
Uninstalling the Driver Libraries .....	43
About Software for Linux .....	44
Driver Software Install Procedure.....	44
Accessing the Help File.....	45
Using Sample Programs .....	45
Uninstalling the driver.....	45

6.	ABOUT HARDWARE	47
----	----------------	----

Hardware specification.....	47
Block Diagram .....	49



# 1. Before Using the Product

This chapter provides information you should know before using the product.

## About the Board

This board is a PCI bus-compliant interface board for input/output of digital signals.

The board can input and output digital signals at 24 - 48VDC.

PIO-32/32H(PCI)H can input and output up to 32 channels.

Using the bundled driver library [API-PAC(W32)], you can create Windows application software for this board in your favorite programming language supporting Win32 API functions, such as Visual Basic or Visual C/C++.

## Features

- Corresponding to the high voltages (24 - 48VDC) I/O.
- A different external power supply can be used for each common pin as it is shared by 16 channels.
- The PCI bus (personal computer) and the I/O interface are isolated from each other by an opto-coupler, offering good noise immunity.
- You can use 32 signal channels of the input signals as interrupt inputs.  
You can also select the interrupt trigger edge of the input signal.
- The board has a digital filter feature to prevent noise or chatter from causing erroneous inputs.
- Up to 60VDC, 100mA per signal, max. output.
- Zener diode connected to output transistors for protection from surge voltage. Overcurrent protective device provided for every eight channels of output transistors.



## Support Software

You should use CONTEC support software according to your purpose and development environment.

### Driver Software Library **API-PAC(W32)** (Bundled)

API-PAC(W32) is the library software that provides the commands for CONTEC hardware products in the form of Windows standard Win32 API functions (DLL). It makes it easy to create high-speed application software taking advantage of the CONTEC hardware using various programming languages that support Win32 API functions, such as Visual Basic and Visual C/C++.

It can also be used by the installed diagnosis program to check hardware operations.

CONTEC provides download services to supply the updated drivers and differential files.

For details, read Help on the bundled CD-ROM or visit the CONTEC's Web site.

< Operating environment >

OS	Windows XP, 2000, Me, 98, etc..
Adaptation language	Visual C++, Visual Basic, Delphi, Builder, etc..
Others	Each piece of library software requires 50 megabytes of free hard disk space.

### Linux version of digital I/O driver **API-DIO(LNX)** (Supplied: Stored on the API-PAC(W32) CD-ROM)

This driver is used to control CONTEC digital I/O boards (PC cards) from within Linux.

You can control CONTEC I/O boards easily using the shared library used by gcc and Kylix, the device driver (module) for each kernel version, and the board (PC card) configuration program (config).

CONTEC provides download services to supply the updated drivers and differential files.

For details, read Help on the bundled CD-ROM or visit the CONTEC's Web site.

< Operating environment >

OS	RedHatLinux, TurboLinux, etc.. (For details on supported distributions, refer to Help available after installation.)
Adaptation language	gcc, Kylix
Others	Each piece of library software requires 3 megabytes of free hard disk space.

### Data acquisition VI library for LabVIEW **VI-DAQ** (Free download)

This is a VI library to use in National Instruments LabVIEW.

VI-DAQ is created with a function form similar to that of LabVIEW's Data Acquisition VI, allowing you to use various devices without complicated settings.

See <http://www.contec.com/vidaq/> for details and download of VI-DAQ.

## Cable & Connector (Option)

Shield Cable with 96-Pin Half-Pitch Connector at Both Ends (Mold Type)	: PCB96PS-0.5P (0.5m)
	: PCB96PS-1.5P (1.5m)
	: PCB96PS-3P (3m)
	: PCB96PS-5P (5m)
Flat Cable with 96-Pin Half-Pitch Connectors at Both Ends	: PCB96P-1.5 (1.5m)
	: PCB96P-3 (3m)
	: PCB96P-5 (5m)
Shield Cable with 96-Pin Half-Pitch Connector at One End (Mold Type)	: PCA96PS-0.5P (0.5m)
	: PCA96PS-1.5P (1.5m)
	: PCA96PS-3P (3m)
	: PCA96PS-5P (5m)
Flat Cable with 96-Pin Half-Pitch Connector at One End	: PCA96P-1.5 (1.5m)
	: PCA96P-3 (3m)
	: PCA96P-5 (5m)
Distribution Shield Cable with 96-Pin Half-Pitch Connector (96Pin→37Pin x 2)	: PCB96WS-1.5P (1.5m)
	: PCB96WS-3P (3m)
	: PCB96WS-5P (5m)
Distribution Flat Cable with 96-Pin Half-Pitch Connector (96Pin→37Pin x 2)	: PCB96W-1.5 (1.5m)
	: PCB96W-3 (3m)
	: PCB96W-5 (5m)
Connector with 96-Pin Half-Pitch Female Set(5 Pieces)	: CN5-H96F

## Accessories (Option)

Relay Terminal Unit for Crimping	:	EPD-96	*1
Terminal Unit for Cables	:	DTP-64(PC)	*1
Relay Terminal Unit for Crimping	:	EPD-37A	*2
Relay Terminal Unit for Crimping	:	EPD-37	*2
Converter Board (96-pin half to two 37-pin female D-SUB)	:	CCB-96	*3

\*1 A PCB96P or PCB96PS optional cable is required separately.

\*2 A PCB96W or PCB96WS optional cable is required separately.

\*3 Option cable PCB96P or PCB96PS, and the cable for 37-pin D-SUB are required separately.

\* Check the CONTEC's Web site for more information on these options.

## Customer Support

CONTEC provides the following support services for you to use CONTEC products more efficiently and comfortably.

### Web Site

Japanese <http://www.contec.co.jp/>  
English <http://www.contec.com/>  
Chinese <http://www.contec.com.cn/>

### Latest product information

CONTEC provides up-to-date information on products.

CONTEC also provides product manuals and various technical documents in the PDF.

### Free download

You can download updated driver software and differential files as well as sample programs available in several languages.

### Note! For product information

Contact your retailer if you have any technical question about a CONTEC product or need its price, delivery time, or estimate information.

## Limited Three-Years Warranty

CONTEC products are warranted by CONTEC CO., LTD. to be free from defects in material and workmanship for up to three years from the date of purchase by the original purchaser.

Repair will be free of charge only when this device is returned freight prepaid with a copy of the original invoice and a Return Merchandise Authorization to the distributor or the CONTEC group office, from which it was purchased.

This warranty is not applicable for scratches or normal wear, but only for the electronic circuitry and original products. The warranty is not applicable if the device has been tampered with or damaged through abuse, mistreatment, neglect, or unreasonable use, or if the original invoice is not included, in which case repairs will be considered beyond the warranty policy.

## How to Obtain Service

For replacement or repair, return the device freight prepaid, with a copy of the original invoice. Please obtain a Return Merchandise Authorization number (RMA) from the CONTEC group office where you purchased before returning any product.

\* No product will be accepted by CONTEC group without the RMA number.

## Liability

The obligation of the warrantor is solely to repair or replace the product. In no event will the warrantor be liable for any incidental or consequential damages due to such defect or consequences that arise from inexperienced usage, misuse, or malfunction of this device.

## Safety Precautions

Understand the following definitions and precautions to use the product safely.

### Safety Information

This document provides safety information using the following symbols to prevent accidents resulting in injury or death and the destruction of equipment and resources. Understand the meanings of these labels to operate the equipment safely.

⚠ DANGER	DANGER indicates an imminently hazardous situation which, if not avoided, will result in death or serious injury.
⚠ WARNING	WARNING indicates a potentially hazardous situation which, if not avoided, could result in death or serious injury.
⚠ CAUTION	CAUTION indicates a potentially hazardous situation which, if not avoided, may result in minor or moderate injury or in property damage.

## Handling Precautions

### DANGER

---

Do not use the product where it is exposed to flammable or corrosive gas. Doing so may result in an explosion, fire, electric shock, or failure.

---

### CAUTION

---

- There are switches and jumpers on the board that need to be set in advance.  
Be sure to check these before installing to the expansion slot.
  - Only set the switches and jumpers on the board to the specified settings.  
Otherwise, the board may malfunction, overheat, or cause a failure.
  - Do not strike or bend the board.  
Otherwise, the board may malfunction, overheat, cause a failure or breakage.
  - Do not touch the board's metal plated terminals (edge connector) with your hands.  
Otherwise, the board may malfunction, overheat, or cause a failure.  
If the terminals are touched by someone's hands, clean the terminals with industrial alcohol.
  - Do not install or remove the board to or from the expansion slot while the computer's power or expansion unit is turned on.  
Otherwise, the board may malfunction, overheat, or cause a failure.  
Be sure that the personal computer power is turned off.
  - Make sure that your PC or expansion unit can supply ample power to all the boards installed.  
Insufficiently energized boards could malfunction, overheat, or cause a failure.
  - The specifications of this product are subject to change without notice for enhancement and quality improvement.  
Even when using the product continuously, be sure to read the manual and understand the contents.
  - Do not modify the product. CONTEC will bear no responsibility for any problems, etc., resulting from modifying this product.
  - Regardless of the foregoing statements, CONTEC is not liable for any damages whatsoever (including damages for loss of business profits) arising out of the use or inability to use this CONTEC product or the information contained herein.
-

## Environment

Use this product in the following environment. If used in an unauthorized environment, the board may overheat, malfunction, or cause a failure.

Operating temperature

0 - 50°C

Operating humidity

10 - 90%RH (No condensation)

Corrosive gases

None

Floating dust particles

Not to be excessive

## Inspection

Inspect the product periodically as follows to use it safely.

- Check that the bus connector of the board and its cable have been plugged correctly.

- Check that the board has no dust or foreign matter adhering.

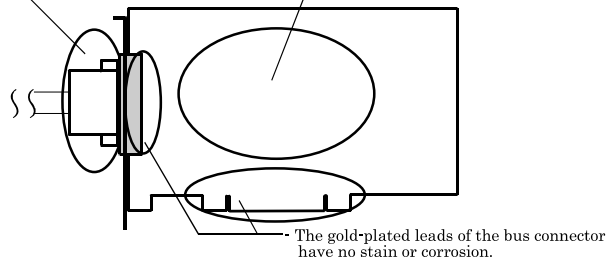

- The gold-plated leads of the bus connector have no stain or corrosion.

## Storage

When storing this product, keep it in its original packing form.

- (1) Put the board in the storage bag.
- (2) Wrap it in the packing material, then put it in the box.
- (3) Store the package at room temperature at a place free from direct sunlight, moisture, shock, vibration, magnetism, and static electricity.

## Disposal

When disposing of the product, follow the disposal procedures stipulated under the relevant laws and municipal ordinances.

## 2. Setup

This chapter explains how to set up the board.

### What is Setup?

Setup means a series of steps to take before the product can be used.

Different steps are required for software and hardware.

The setup procedure varies with the OS and software used.

### Using the Board under Windows

#### Using the Driver Library API-PAC(W32)

This section describes the setup procedure to be performed before you can start developing application programs for the board using the bundled CD-ROM “Driver Library API-PAC(W32)”.

Taking the following steps sets up the software and hardware. You can use the diagnosis program later to check whether the software and hardware function normally.

**Step 1 Installing the Software**

**Step 2 Setting the Hardware**

**Step 3 Installing the Hardware**

**Step 4 Initializing the Software**

**Step 5 Checking Operations with the Diagnosis Program**

If Setup fails to be performed normally, see the “Setup Troubleshooting” section at the end of this chapter.

### Using the Board under Windows

#### Using Software Other than the Driver Library API-PAC(W32)

For setting up software other than API-PAC(W32), refer to the manual for that software. See also the following parts of this manual as required.

**This chapter Step 2 Setting the Hardware**

**This chapter Step 3 Installing the Hardware**

**Chapter 3 External Connection**

**Chapter 6 About Hardware**



## Using the Board under an OS Other than Windows

For using the board under Linux, see the following parts of this manual.

**This chapter Step 2 Setting the Hardware**

**Chapter 3 External Connection**

**Chapter 5 About Software**

**Chapter 6 About Hardware**

For using the board under an OS such as MS-DOS other than Windows, see the following parts of this manual.

**This chapter Step 2 Setting the Hardware**

**Chapter 3 External Connection**

**Chapter 6 About Hardware**

## Step 1 Installing the Software

This section describes how to install the Driver libraries.

**Before installing the hardware on your PC, install the Driver libraries from the bundled API-PAC(W32) CD-ROM.**

The following description assumes the operating system as Windows XP. Although some user interfaces are different depending on the OS used, the basic procedure is the same.

### Starting the Install Program

- (1) Load the CD-ROM [API-PAC(W32)] on your PC.
- (2) The API-PAC(W32) Installer window appears automatically.  
If the panel does not appear, run (CD-ROM drive letter):\AUTORUN.exe.
- (3) Click on the [Install the drivers] button.

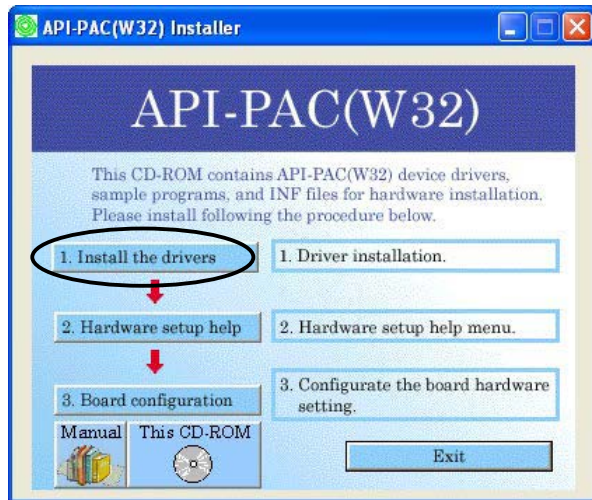

### ⚠ CAUTION

Before installing the software in Windows XP, 2000, or NT, log in as a user with administrator privileges.

## Selecting the Digital I/O Driver

- (1) The following dialog box appears to select “Driver Type” and “Install Type”.
- (2) Select “Digital I/O”.
- (3) Select “Driver, Help, etc... (Full install)”.
- (4) Click on the [Install] button.

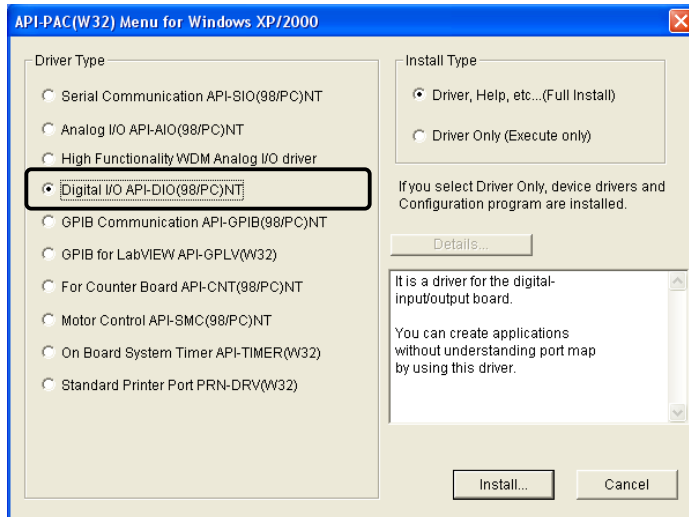

## Executing the Installation

- (1) Follow the on-screen instructions to proceed to install.
- (2) When the required files have been copied, the “Perform a hardware setup now” and “Show readme file” check boxes are displayed.

**When you are installing the software or hardware for the first time:**

1) Uncheck “Perform a hardware setup now”.

2) Click on the [Finish] button.

Go to Step 2 to set and plug the hardware.

\* When the hardware has already been installed:

Check the “Perform a hardware setup now” and then go to the Step 4 “Initializing the Software”.

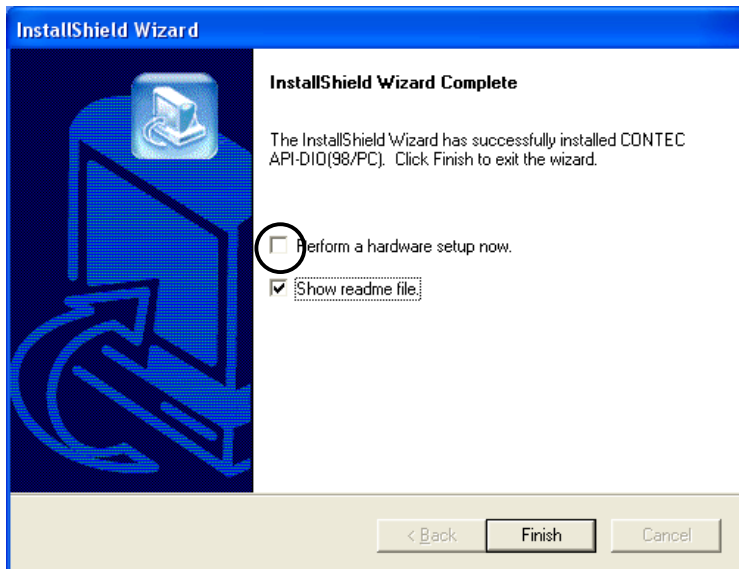

**You have now finished installing the software.**

## Step 2 Setting the Hardware

This section describes how to set the board and plug it on your PC.

The board has some switches and jumper to be preset.

Check the on-board switches and jumpers before plugging the board into an expansion slot.

The board can be set up even with the factory defaults untouched. You can change board settings later.

### Parts of the Board and Factory Defaults

Figure 2.1. shows the names of major parts on the board.

Note that the switch setting shown below is the factory default.

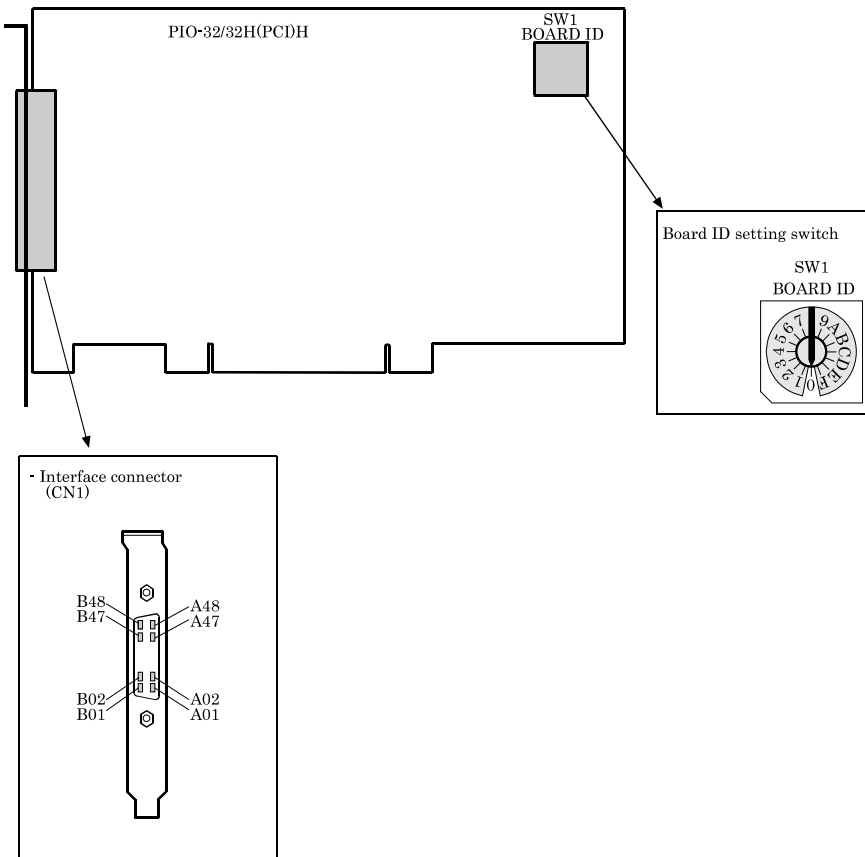

**Figure 2.1. Component Locations**

## Setting the Board ID

If you install two or more boards on one personal computer, assign a different ID value to each of the boards to distinguish them.

The board IDs can be set from 0 - Fh to identify up to sixteen boards.

If only one board is used, the original factory setting (Board ID = 0) should be used.

### Setting Procedure

To set the board ID, use the rotary switch on the board. Turn the SW1 knob to set the board ID as shown below.

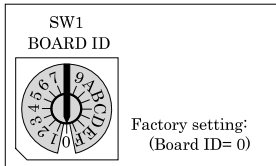

**Figure 2.2. Board ID Settings (SW1)**

## Plugging the Board

- (1) Before plugging the board, shut down the system, unplug the power cord of your PC.
- (2) Remove the cover from the PC so that the board can be mounted.
- (3) Plug the board into an expansion slot.
- (4) Attach the board bracket to the PC with a screw.
- (5) Put the cover back into place.



### Applicable PCI bus slots

PCI bus slots used in PCs have keys to prevent 5V and 3.3V PCI bus boards from being accidentally plugged into wrong bus slots. This board can be plugged into both of the 5V and 3.3V PCI bus slots.

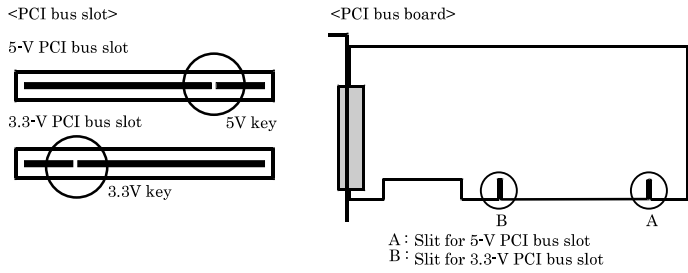

### ⚠ CAUTION

- Do not touch the board's metal plated terminals (edge connector) with your hands. Otherwise, the board may malfunction, overheat, or cause a failure. If the terminals are touched by someone's hands, clean the terminals with industrial alcohol.
- Do not install or remove the board to or from the slot while the computer's power or expansion unit is turned on. Otherwise, the board may malfunction, overheat, or cause a failure. Be sure that the personal computer power is turned off.
- Make sure that your PC or expansion unit can supply ample power to all the boards installed. Insufficiently energized boards could malfunction, overheat, or cause a failure.
- Power supply from the PCI bus slot at +5V is required.

## Step 3 Installing the Hardware

For using an expansion board under Windows, you have to let the OS detect the I/O addresses and interrupt level to be used by the board. The process is referred to as installing the hardware.

In the case of using two or more boards, make sure you install one by one with the Add New Hardware Wizard.

### Turning on the PC

Turn on the power to your PC.

#### ⚠ CAUTION

- The board cannot be properly installed unless the resources (I/O addresses and interrupt level) for the board can be allocated. Before attempting to install the board, first determine what PC resources are free to use.
- The resources used by each PCI bus board do not depend on the location of the PCI bus slot or the board itself. If you remove two or more boards that have already been installed and then remount one of them on the computer, it is unknown that which one of the sets of resources previously assigned to the two boards is assigned to the remounted board. In this case, you must check the resource settings.

### Setting with the Found New Hardware Wizard

- (1) The “Found New Hardware Wizard” will be started.

Select “Install from a list or specific location”, then click on the [Next] button.

**If you are using Windows NT 4.0, the “Found New Hardware Wizard” is not started.**

**Go to Step 4 “Initializing the Software”.**

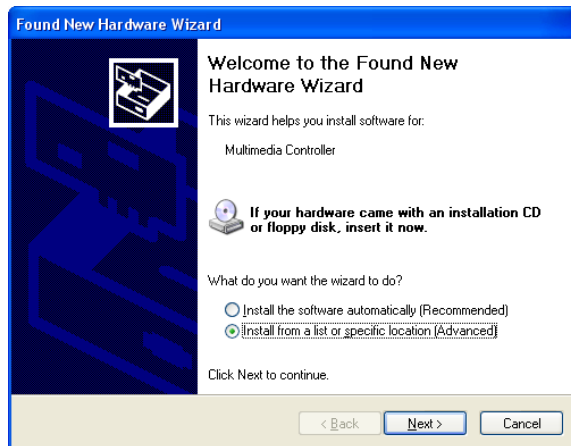



- (2) Specify that folder on the CD-ROM which contains the setup information (INF) file to register the board.

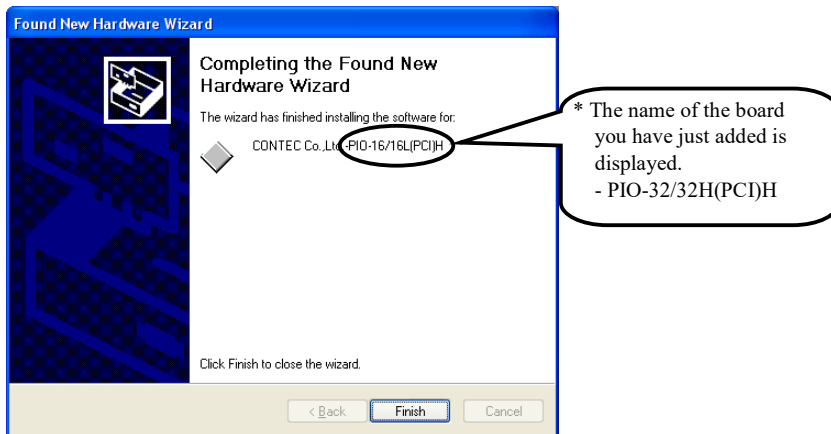

#### Source folder

The setup information (INF) file is contained in the following folder on the bundled CD-ROM.

Windows XP, 2000    \INF\Win2000\Dio\PCI  
 Windows Me, 98, 95    \INF\Win95\Dio\PCI

#### Example of specifying the folder for use under Windows XP

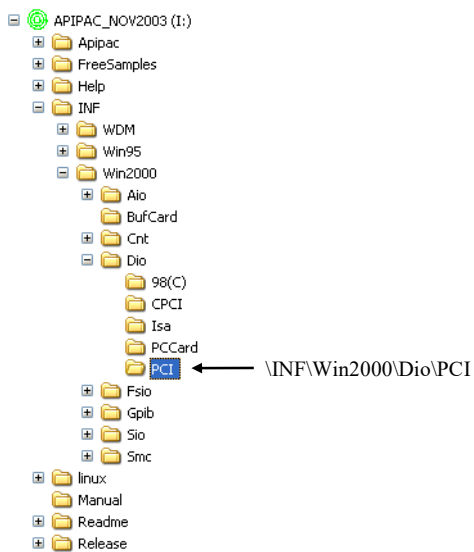

**⚠ CAUTION**

In Windows XP, the Hardware Wizard displays the following alert dialog box when you have located the INF file. This dialog box appears, only indicating that the relevant driver has not passed Windows Logo testing, and it can be ignored without developing any problem with the operation of the board.

**In this case, click on the [Continue Anyway] button.**

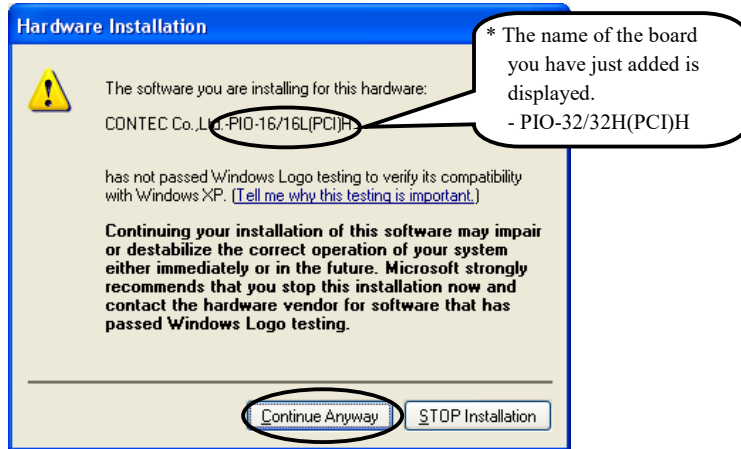

You have now finished installing the software.

## Step 4 Initializing the Software

The driver library requires the initial setting to recognize the execution environment. It is called the initialization of the Driver library.

### Invoking API-TOOL Configuration

- (1) Open the Start Menu, then select “Programs” – “CONTEC API-PAC(W32)” – “API-TOOL Configuration”.

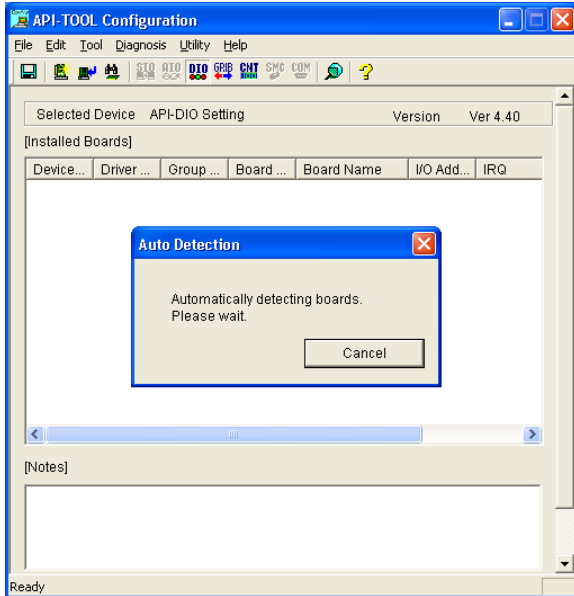

- (2) API-TOOL Configuration detects hardware automatically.  
The detected boards are listed.

### Updating the Settings

- (1) Select “Save settings to registry...” from the “File” menu.

**You have now finished installing the initial setting of Software.**

## Step 5 Checking Operations with the Diagnosis Program

Use the diagnosis program to check that the board and driver software work normally, thereby you can confirm that they have been set up correctly.

### What is the Diagnosis Program?

The diagnosis program diagnoses the states of the board and driver software.

It can also be used as a simple checker when an external device is actually connected.

Using the “Diagnosis Report” feature reports the driver settings, the presence or absence of the board, I/O status, and interrupt status.

### Check Method

Connect the board to a remote device to test the input/output and check the execution environment.

For this board, prepare an external power supply (24 - 48V).

To connect the external device, see Chapter 3 “External Connection”.

## Using the Diagnosis Program

### Starting the Diagnosis Program

Select the board in the API-TOOL Configuration windows, then run the Diagnosis Program. Follow the instructions on screen.

\* The name of the board you have just added is displayed.

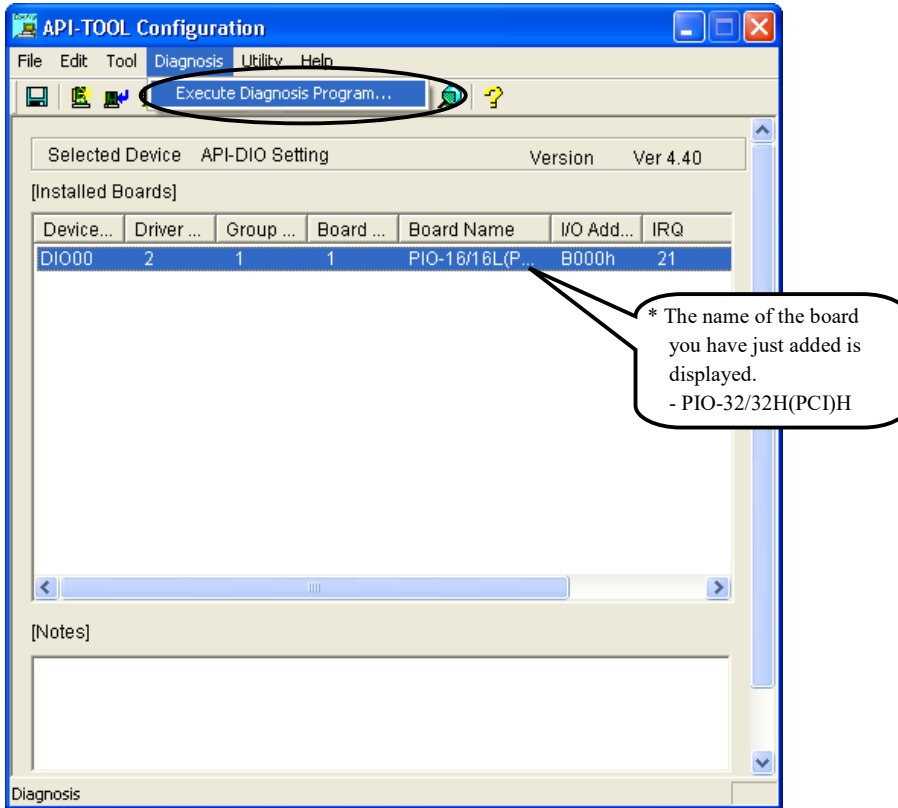

### Checking Digital Inputs and Outputs

The main panel of the Diagnosis Program appears.

You can check the current operation states of the board in the following boxes:

“Input Port” : Displays input values bit by bit at fixed time intervals.

“Output Port” : Mouse operation allows the data to output or display.

“Interrupt” : Displays the number of interrupts detected bit by bit.

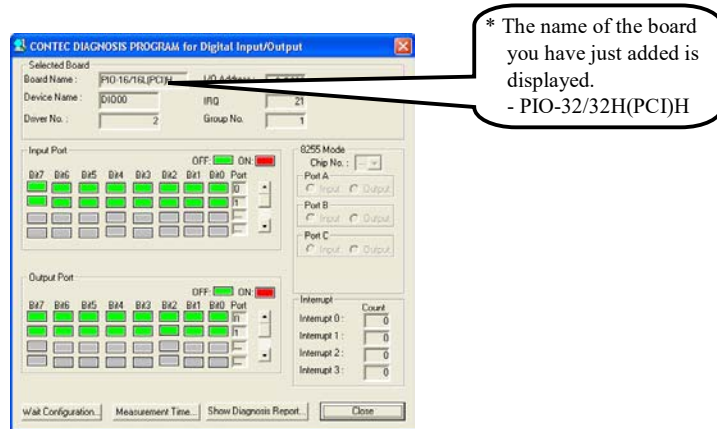

To use the wait time control feature, click on the [Wait Configuration] button. Use the feature when the wait time based on the DioWait or DioWaitEx function is not normal.

To use the function execution time measurement feature, click on the [Measurement Time] button. Enter the I/O start port and the number of ports, then press the measurement button. The time for each execution of a function will be measured.

Diagnosis Report

- (1) Clicking on the [Show Diagnosis Report] button displays detailed data such as board settings and the diagnosis results while saving them in text format.

The results are saved and displayed as a text file (DioRep.txt) in the install folder (Program Files\CONTEC\API-PAC(W32)).

The Diagnosis Program performs “board presence/absence check”, “driver file test”, “board setting test”, and so on.

**CAUTION**

Before executing diagnosis report output, unplug the cable from the board.

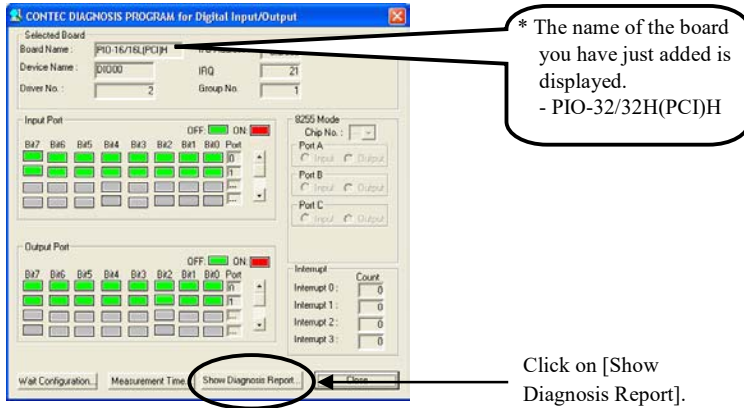

- (2) A diagnosis report is displayed as shown below.

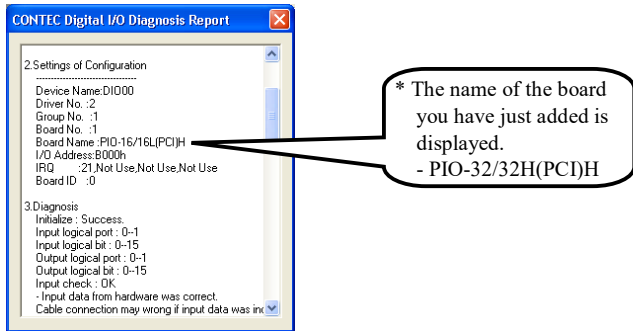

# Setup Troubleshooting

## Symptoms and Actions

The board cannot be initialized [Windows NT 4.0]

The driver may not yet be activated.

When using the board under an OS not compliant with Plug and Play, such as Windows NT 4.0, make sure that the [PnP OS] BIOS option has been set to [NO], [disable], or [Do not use]. If the option has been set to [Windows 95], for example, the board may not be detected normally. For details on BIOS settings, refer to the user's guide for your PC.

No output can be obtained.

Use API-TOOL Configuration to check whether the board name setting is wrong.

The board works with the Diagnosis Program but not with an application.

The Diagnosis Program is coded with API-TOOL functions. As long as the board operates with the Diagnosis Program, it is to operate with other applications as well. In such cases, review your program while paying attention to the following points:

- Check the arguments to functions and their return values.
- When the board is an isolated type, it has a time lag for its response between the output by a function and the actual output. Consider the execution intervals between functions.

The OS won't normally get started or detect the board. [Windows XP, 2000]

Turn off the power to your PC, then unplug the board. Restart the OS and delete the board settings of API-TOOL Configuration. Turn off the PC again, plug the board, and restart the OS. Let the OS detect the board and use API-TOOL Configuration to register board settings.

## If your problem cannot be resolved

Contact your retailer.





## 3. External Connection

This chapter describes the interface connectors on the board and the external I/O circuits. Check the information available here when connecting an external device.

### Using the On-board Connectors

#### Connecting a Device to a Connector

To connect an external device to this board, plug the cable from the device into the interface connector shown below.

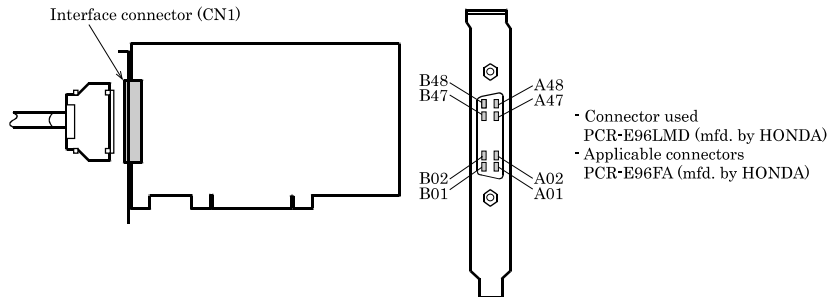
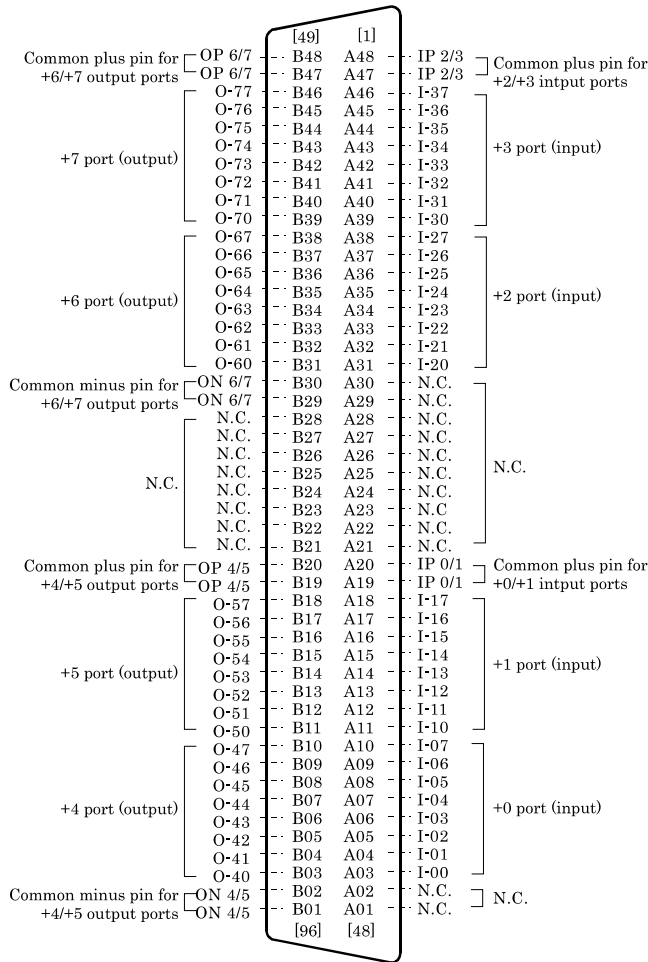

Figure 3.1. Interface Connector and Applicable Cable Connector

### Connector Pin Assignment



\* I-00 - I-37 can be used as interrupt signal.  
 The numbers in square brackets [ ] are pin numbers designated by  
 HONDA TSUSHIN KOGYO CO., LTD.

I-00 - I-37	32 input signal pins. Connect output signals from the external device to these pins.
O-40 - O-77	32 output signal pins. Connect these pins to the input signal pins of the external device.
IP 0/1 - IP 2/3	Connect the positive side of the external power supply. These pins are common to 16 input signal pins.
OP 4/5 - OP 6/7	Connect the positive side of the external power supply. These pins are common to 16 output signal pins.
ON 4/5 - ON 6/7	Connect the negative side of the external power supply. These pins are common to 16 output signal pins.
N.C.	This pin is left unconnected.

Figure 3.2. Pin Assignments of Interface Connector

## Relationships between API-PAC(W32) Logical Ports/Bits and Connector Signal Pins

The following table lists the relationships between the connector signal pins and the logical port/bit numbers used for I/O functions when applications are written with API-PAC(W32).

**Table 3.1. Logical Ports, Logical Bits, and Connector Signal Pins**

	D7	D6	D5	D4	D3	D2	D1	D0
Input Logical Ports0	I-07 [7]	I-06 [6]	I-05 [5]	I-04 [4]	I-03 [3]	I-02 [2]	I-01 [1]	I-00 [0]
Input Logical Ports1	I-17 [15]	I-16 [14]	I-15 [13]	I-14 [12]	I-13 [11]	I-12 [10]	I-11 [9]	I-10 [8]
Input Logical Ports2	I-27 [23]	I-26 [22]	I-25 [21]	I-24 [20]	I-23 [19]	I-22 [18]	I-21 [17]	I-20 [16]
Input Logical Ports3	I-37 [31]	I-36 [30]	I-35 [29]	I-34 [28]	I-33 [27]	I-32 [26]	I-31 [25]	I-30 [24]

	D7	D6	D5	D4	D3	D2	D1	D0
Output Logical Ports0	O-47 [7]	O-46 [6]	O-45 [5]	O-44 [4]	O-43 [3]	O-42 [2]	O-41 [1]	O-40 [0]
Output Logical Ports1	O-57 [15]	O-56 [14]	O-55 [13]	O-54 [12]	O-53 [11]	O-52 [10]	O-51 [9]	O-50 [8]
Output Logical Ports2	O-67 [23]	O-66 [22]	O-65 [21]	O-64 [20]	O-63 [19]	O-62 [18]	O-61 [17]	O-60 [16]
Output Logical Ports3	O-77 [31]	O-76 [30]	O-75 [29]	O-74 [28]	O-73 [27]	O-72 [26]	O-71 [25]	O-70 [24]

Note : I-xx represents an input signal; O-xx is an output signal.  
[xx] represents a logical bits.



### CAUTION

The logical port and logical bit numbers are virtual port and bit numbers that enable programming independent of board I/O addresses or board types.

For details, refer to API-DIO HELP available after installing API-PAC(W32).

## Connecting Input Signals

Connect the input signals to a device which can be current-driven, such as a switch or transistor output device.

The connection requires an external power supply to feed currents.

The board inputs the ON/OFF state of the current-driven device as a digital value.

### Input Circuit

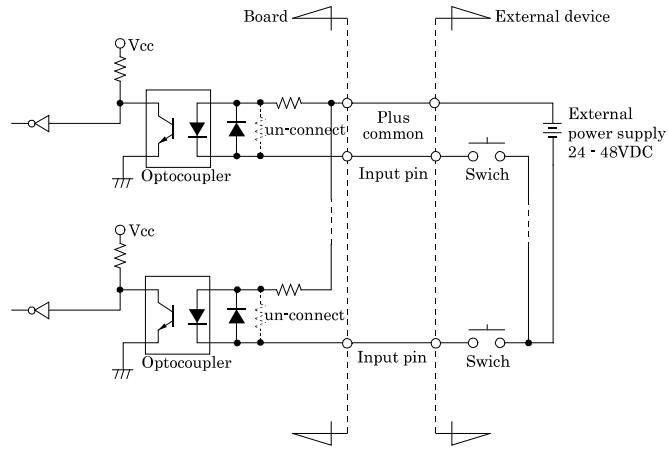

\* Input pin represents I-xx.

**Figure 3.3. Input Circuit**

The input circuits of interface blocks of the PIO-32/32H(PCI)H are illustrated in Figure 3.3.

The signal inputs are isolated by opto-couplers (ready to accept current sinking output signals). The board therefore requires an external power supply to drive the inputs. The power requirement for each input pin is about 3.2mA at 48VDC (about 1.6mA at 24VDC).

### Connecting a Switch

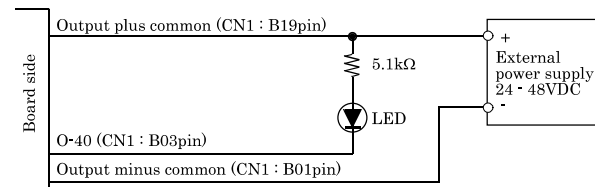

When "1" is output to a relevant bit, the corresponding LED comes on.

When "0" is output to the bit, in contrast, the LED goes out.

**Figure 3.4. An Example to use Input I-00**

## Connecting Output Signals

Connect the output signals to a current-driven controlled device such as a relay or LED.

The connection requires an external power supply to feed currents.

The board controls turning on/off the current-driven controlled device using a digital value.

### Output Circuit

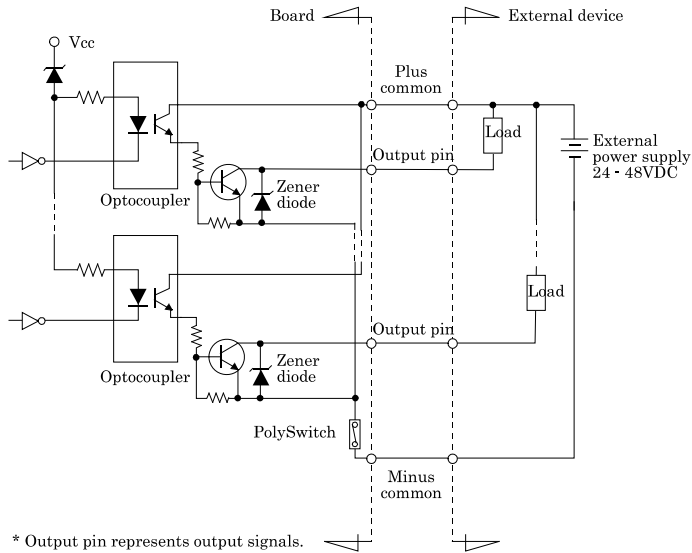

**Figure 3.5. Output Circuit**

The output circuits of interface blocks of the PIO-32/32H(PCI)H are illustrated in Figure 3.5. The signal output section is an opto-coupler isolated, open-collector output (current sink type). Driving the output section requires an external power supply.

The rated output current per channel is 100mA at maximum.

The output section can also be connected to a TTL level input as it uses a low-saturated transistor for output. The residual voltage (low-level voltage) between the collector and emitter with the output on is 0.5V or less at an output current within 50mA or at most 1.0V at an output current within 100mA.

A zener diode is connected to the output transistor for protection from surge voltages. A PolySwitch-based overcurrent protector is provided for every eight output transistors. When the overcurrent protector works, the output section of the board is temporarily disabled. If this is the case, turn off the power to the PC and the external power supply and wait for a few minutes, then turn them on back.



#### CAUTION

When the PC is turned on, all output are reset to OFF.

### Connection to the LED

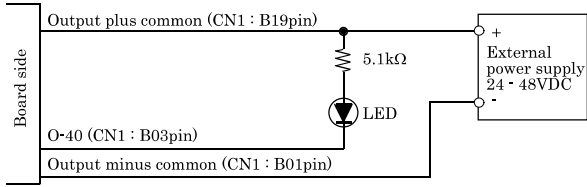

When "1" is output to a relevant bit, the corresponding LED comes on.  
 When "0" is output to the bit, in contrast, the LED goes out.

Figure 3.6. An Example to use Output O-40

### Example of Connection to TTL Level Input

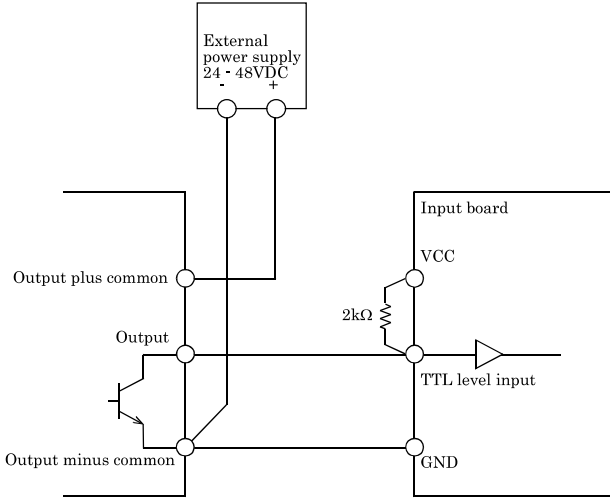
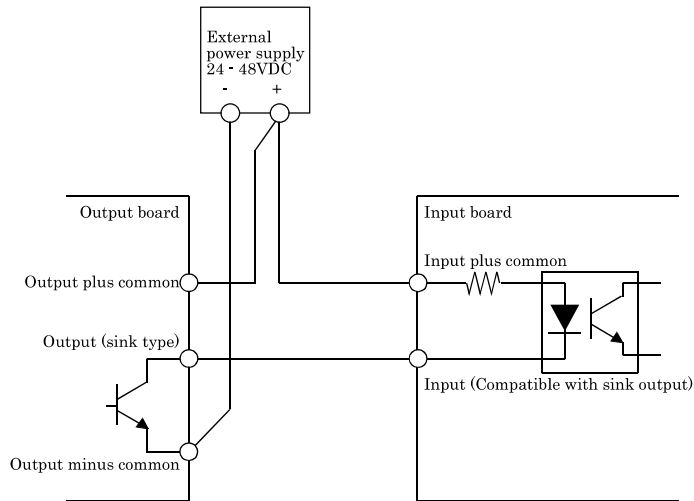

Figure 3.7. Connection Example of Output and TTL level Input Signal

## Connecting the Sink Type Output and Sink Output Support Input

The following example shows a connection between a sink type output (output board) and a sink output support input (input board). Refer to this connection example when you connect such boards to each other.



**Figure 3.8.** Example of Connecting the Sink Type Output and Sink Output Support Input





## 4. Function

This section describes the features of the board.

Each function described here can be easily set and executed by using the bundled API driver library.  
For details, refer to API-DIO HELP available after installation.

### Data I/O Function

#### Data Input

When input data is “ON”, “1” is input to the relevant bit.  
When the input data is “OFF”, in contrast, “0” is input to the relevant bit.

#### Data Output

When “1” is output to the relevant bit, the corresponding transistor is set to “ON”.  
When “0” is output to the relevant bit, in contrast, the corresponding transistor is set to “OFF”.



---

#### CAUTION

When the PC is turned on, all output are reset to 0 (OFF).

---

#### Monitoring Output Data

The PIO-32/32H(PCI)H can read the state of the data currently being output without affecting the output data.

## Digital Filter

Using this feature, the PIO-32/32H(PCI)H can apply a digital filter to every input pin, thereby preventing the input signal from being affected by noise or chattering.

### Digital Filter Function Principle

The digital filter checks the input signal level during the sampling time of the clock signal. When the signal level remains the same for the digital filter set time, the digital filter recognizes that signal as the input signal and changes the signal level of the PC.

If the signal level changes at a frequency shorter than the set time, therefore, the level change is ignored.

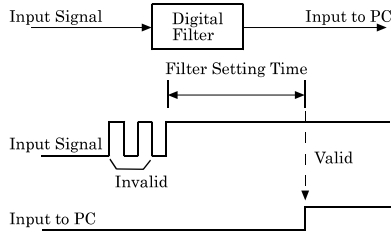

Figure 4.1. Digital Filter Function Principle

### Set Digital Filter Time

Set the digital filter time to 0 - 20 (14h).

Setting the digital filter time to 0 disables digital filtering. It is set to 0 when the power is turned on.

Figure 4.2 shows the relationships between the digital filter time and the setting data.

$$\text{Digital Filter Time[sec.]} = 2^n / (8 \times 10^6)$$

$$n: = \text{setting data}(0 - 20)$$

Setting Data (n)	Digital Filter Time	Setting Data (n)	Digital Filter Time	Setting Data (n)	Digital Filter Time
0 (00h)	The filter function is not used.	7 (07h)	16μsec	14 (0Eh)	2.048msec
1 (01h)	0.25μsec	8 (08h)	32μsec	15 (0Fh)	4.096msec
2 (02h)	0.5μsec	9 (09h)	64μsec	16 (10h)	8.192msec
3 (03h)	1μsec	10 (0Ah)	128μsec	17 (11h)	16.384msec
4 (04h)	2μsec	11 (0Bh)	256μsec	18 (12h)	32.768msec
5 (05h)	4μsec	12 (0Ch)	512μsec	19 (13h)	65.536msec
6 (06h)	8μsec	13 (0Dh)	1.024msec	20 (14h)	131.072msec

Figure 4.2. Digital Filter Time and Setting Data

### ⚠ CAUTION

- If you set the digital filter time, the filter applies to all input pins. You cannot apply the filter only to a specific input pin.
- Do not set a value outside the above range to the Setting Data as doing so can cause the board to malfunction.

## Interrupt Control Function

The PIO-32/32H(PCI)H can use all of the input signals as interrupt request signals.

The board can generate an interrupt request signal to the PC when the input signal changes from High to Low or from Low to High.

When the digital filter (described above) is used, interrupt requests are generated by input signals that have passed through the filter.

### Disabling/enabling Interrupts

Interrupt mask bits can be used to disable or enable the individual bits for interruptions.

Once a certain bit has been interrupt-disabled, no interrupt occurs even when the corresponding input signal changes its level.

To let interrupts occur, enable the corresponding interrupt mask bit for interruptions.



#### CAUTION

All of the interrupt mask bits are interrupt-disabled when the power is turned on.

---

### Selecting the Interrupt Edge

Interrupt edge select bits can be used to set the input logic for interruption bit by bit.

If you set an interrupt edge select bit to 0, an interrupt occurs when the input value to the corresponding bit changes from 0 to 1 (at the fall of the input signal from High to Low).

If you set an interrupt edge select bit to 1, an interrupt occurs when the input value to the corresponding bit changes from 1 to 0 (at the rise of the input signal from Low to High).



#### CAUTION

When the power is turned on, all of the interrupt edge select bits are set to 0 so that an interrupt occurs when the input value changes from 0 to 1 (at the fall of the input signal from High to Low).

---

## Clearing the Interrupt Status and Interrupt Signal

Interrupt status bits are used to identify the input signal bit being used for requesting an interrupt. When an interrupt status is input, the interrupt request signal and the interrupt status are cleared automatically.

### CAUTION

---

- All of the interrupt status bits are set to 0 when the power is turned on.
  - If an interrupt mask bit has been set to disable interrupts, the interrupt status bit is not set even when the input signal changes its level.
-

## 5. About Software

### CD-ROM Directory Structure

```

\
|—Autorun.exe           Installer Main Window
|  |—Readmej.html       Version information on each API-TOOL (Japanese)
|  |—Readmeu.html       Version information on each API-TOOL (English)
|  .
|  .
|  |—APIPAC             Each installer
|  |  |—AIO
|  |  |  |—DISK1
|  |  |  |—DISK2
|  |  |  |—.....
|  |  |  |—DISKN
|  |  |—AioWdm
|  |  |—CNT
|  |  |—DIO
|  |  |—.....
|  .
|  |—HELP              HELP file
|  |  |—Aio
|  |  |—Cnt
|  |  |—.....
|  .
|  |—INF               Each INF file for OS
|  |  |—WDM
|  |  |—Win2000
|  |  |—Win95
|  .
|  |—linux            Linux driver file
|  |  |—cnt
|  |  |—dio
|  |  |—.....
|  .
|  |—Readme           Readme file for each driver
|  .
|  |—Release          Driver file on each API-TOOL
|  |  |—API_NT        (For creation of a user-specific install program)
|  |  |—API_W95
|  .
|  |—UsersGuide       Hardware User's Guide(PDF files)

```

## About Software for Windows

The bundled CD-ROM “Driver Library API-PAC(W32)” contains the functions that provide the following features:

- Digital input/output of specified ports
- Hardware digital input/output of specified bits
- Hardware digital filtering that prevents chattering

For details, refer to the help file. The help file provides various items of information such as “Function Reference”, “Sample Programs”, and “FAQs”. Use them for program development and troubleshooting.

### Accessing the Help File

- (1) Click on the [Start] button on the Windows taskbar.
- (2) From the Start Menu, select “Programs” – “CONTEC API-PAC(W32)” – “Dio” – “API-DIO HELP” to display help information.

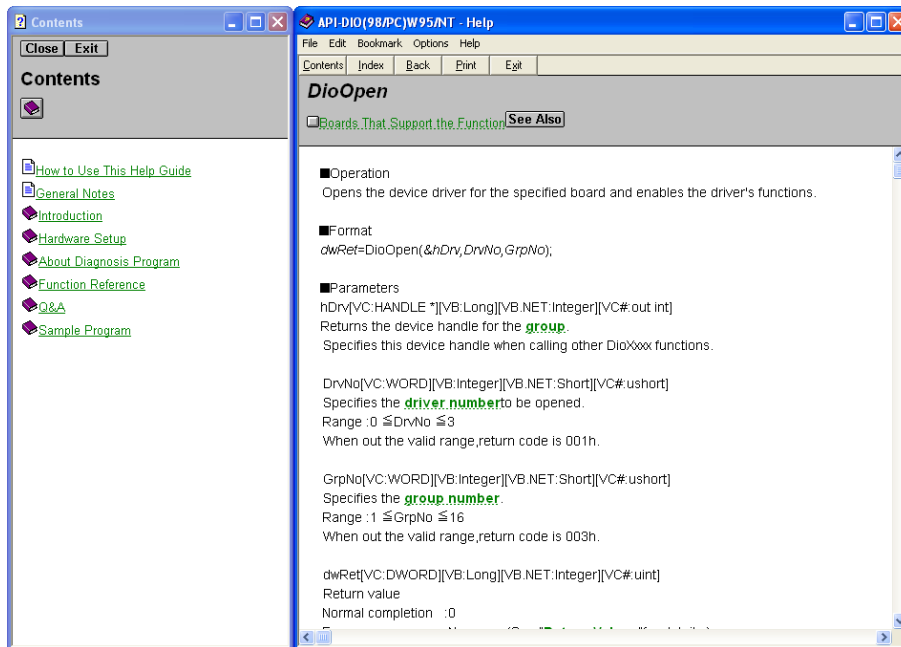

## Using Sample Programs

Sample programs have been prepared for specific basic applications.

To use each sample program, enter its driver number and group number set by API-TOOL Configuration in the DrvNo and GrpNo fields.

Use these sample programs as references for program development and operation check.

The sample programs are stored in \Program Files\CONTEC\API-PAC(W32)\Dio\Samples.

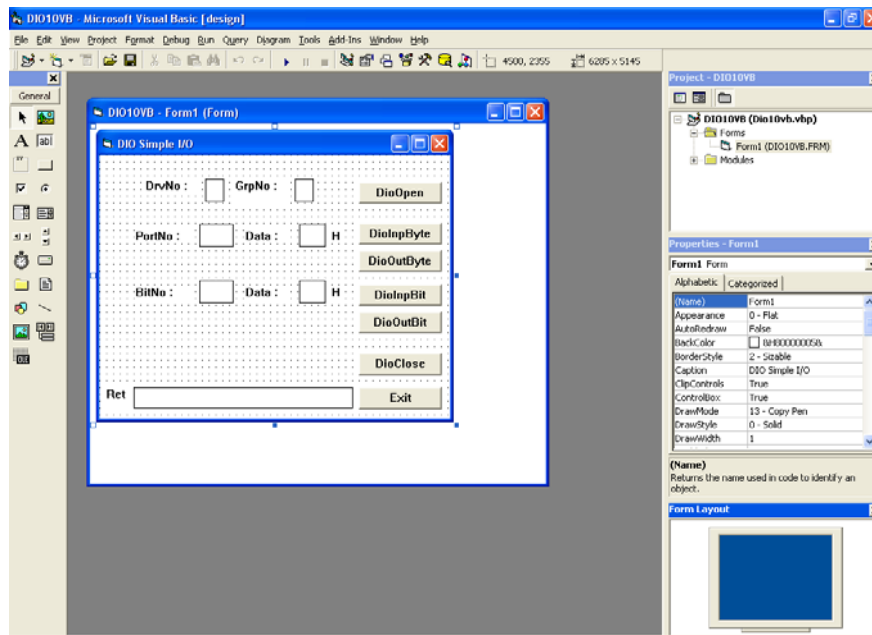

### Running a Sample Program

- (1) Click on the [Start] button on the Windows taskbar.
- (2) From the Start Menu, select “Programs” – “CONTEC API-PAC(W32)” – “Dio” – “SAMPLE...”.
- (3) A sample program is invoked.



Sample Programs - Examples

- Sample program 1 : Inputs digital data through a specified port.
- Sample program 2 : Outputs digital data through a specified port.
- Sample program 3 : Inputs/outputs digital data from/to a programmable board.
- Sample program 4 : Inputs digital data from a specified port in the background.
- Sample program 5 : Inputs/outputs digital data from/to a specified bit.
- Sample program 6 : Services interrupts of a specified board.
- Sample program 7 : Provides process control of a specified board.
- Sample program 8 : Performs trigger monitoring of a specified board.
- Sample program 9 : Inputs digital data through a specified port using BCD data.
- Sample program 10 : Executes digital input (simple functions) at specified bits through a specified port.
- Sample program 11 : Services interrupts of a specified board (using an extended function).
- Sample program (Console) : Inputs/outputs digital data through a specified port.

[Sample program 1]

[Sample program 2]

[Sample program 5]

[Sample program 9]

## Uninstalling the Driver Libraries

To uninstall API-PAC(W32), follow the procedure below.

- (1) Click on the [Start] button on the Windows taskbar. From the Start Menu, select “Settings” – “Control Panel”.
- (2) Double-click on “Add/Remove Programs” in the Control Panel.
- (3) Select “CONTEC API-DIO(98/PC)xx” from the application list displayed, then click on the [Add/Remove] button. Follow the on-screen instructions to uninstall the function libraries.

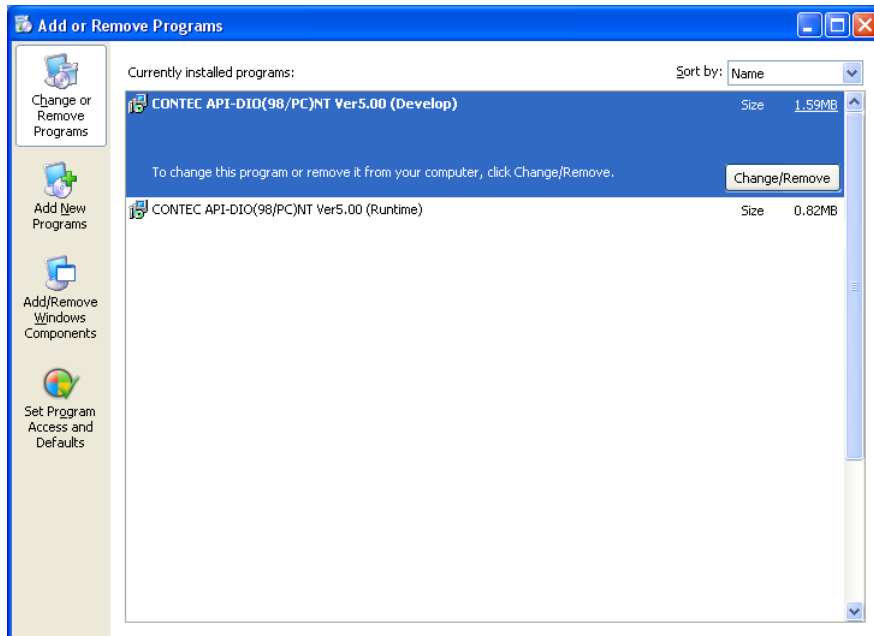

## About Software for Linux

The Linux version of digital I/O function driver, API-DIO(LNX), provides functions that execute the following features:

- Digital input/output of specified ports
- Digital input/output of specified bits
- Hardware digital filtering that prevents chattering

For details, refer to the help file. The help file provides various items of information such as “Function Reference”, “Sample Programs”, and “FAQs”. Use them for program development and troubleshooting.

## Driver Software Install Procedure

The Linux version for digital I/O driver, API-DIO(LNX), is supplied as a compressed file /linux/dio/cdioXXX.tgz on the bundled API-PAC(W32)CD-ROM. (Note: XXX represents the driver version.)

Mount the CD-ROM as shown below, copy the file to an arbitrary directory, and decompress the file to install the driver.

For details on using the driver, refer to readme.txt and the help file in HTML format extracted by installation.

To install the driver, log in as a superuser.

Decompression and setup procedure

```
# cd
# mount /dev/cdrom /mnt/cdrom           Mount the CD-ROM.
# cp /mnt/cdrom/linux/dio/cdioXXX.tgz ./ Copy the compressed file.
# tar xvfz cdioXXX.tgz                 Decompress the compressed file.
.....
# cd contec/cdio
# make                                 Compile the file.
.....
# make install                         Install.
.....
# cd config
# ./config                             Set up the board to be used.
..... Set as follows.....
# ./contec_dio_start.sh                Start the driver.
# cd
```

## Accessing the Help File

- (1) Invoke a web browser in your X-Window environment.
- (2) In the browser, open diohelp.htm in the contec/cdio/help directory.

## Using Sample Programs

Sample programs have been prepared for specific basic applications.

Sample programs for each language are contained in the contec/cdio/samples directory. For compiling them, refer to the manual for the desired language.

## Uninstalling the driver

To uninstall the driver, use the uninstall shell script contained in the contec/cdio directory. For details, check the contents of the script.



## 6. About Hardware

This chapter provides hardware specifications and hardware-related supplementary information.

### Hardware specification

Table 6.1. Specification < 1 / 2 >

Item	Specification	
<b>Input</b>		
Input format	Opto-isolated input (Compatible with current sink output)(Negative logic *1)	
Number of input signal channels	32 channels (all available for interrupts) (One common power supply per 16 channels)	
Input resistance	15kΩ	
Input ON current	1.36mA or more	
Input OFF current	0.16mA or less	
Interrupt	32 interrupt input signals are arranged into a single output of interrupt signal INTA. An interrupt is generated at the falling edge (HIGH-to-LOW transition) or rising edge (LOW-to-HIGH transition).	
Response time	200μsec within	
<b>Output</b>		
Output format	Opto-isolated open collector output (Compatible with current sink)(Negative logic *1)	
Number of output signal channels	32 channels (One common power supply per 16 channels)	
Output rating	Output voltage	60VDC (Max.)
	Output current	100mA (par channel) (Max.)
Residual voltage with output on	0.5V or less (Output current≤50mA), 1.0V or less (Output current≤100mA)	
Surge protector	Zener diode RD68FM(NEC) or the equivalence for it	
Response time	200μsec within	

**Table 6.1. Specification < 2 / 2 >**

Item	Specification
Common	
I/O address	8 bits x 32 ports
Interruption level	1 level use
Max. board count for connection	16 boards including the master board
Dielectric strength	500Vrms
External circuit power supply	24 - 48VDC(±10%)
Power consumption	5VDC 200mA(Max.)
Operating condition	0 - 50°C, 10 - 90%RH (No condensation)
Allowable distance of signal extension	Approx. 50m (depending on wiring environment)
PCI bus specification	32bit, 33MHz, Universal key shapes supported *2
Dimension (mm)	176.41 (L) x 105.68(H)
Weight	215g

\*1 Data "0" and "1" correspond to the High and Low levels, respectively.

\*2 This board requires power supply at +5V from an expansion slot (it does not work on a machine with a +3.3V power supply alone).

#### Board Dimensions

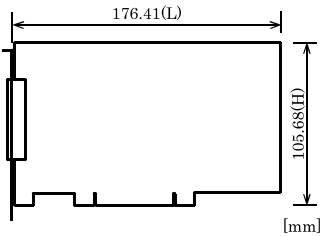

The standard outside dimension (L) is the distance from the end of the board to the outer surface of the slot cover.

## Block Diagram

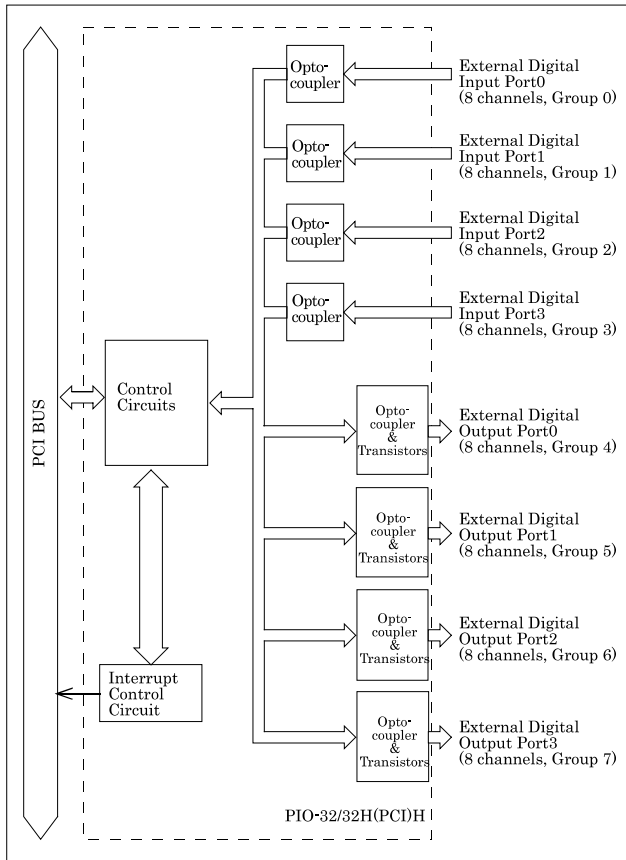

Figure 6.1. Block Diagram



# PIO-32/32H(PCI)H

## User's Guide

---

CONTEC CO., LTD.

April 2016 Edition

3-9-31, Himesato, Nishiyodogawa-ku, Osaka 555-0025, Japan

Japanese <http://www.contec.co.jp/>

English <http://www.contec.com/>

Chinese <http://www.contec.com.cn/>

No part of this document may be copied or reproduced in any form by any means without prior written consent of CONTEC CO., LTD. [04012016]

---

[08052004]

Management No. A-46-891

[04012016\_rev3]

Parts No. LYDW822