

PC-HELPER

Reverse-Common Digital I/O Board
with Opto-Isolation

PIO-32/32RL(PCI)H

User's Guide

CONTEC CO.,LTD.

Check Your Package

Thank you for purchasing the CONTEC product.

The product consists of the items listed below.

Check, with the following list, that your package is complete. If you discover damaged or missing items, contact your retailer.

Product Configuration List

- Board [PIO-32/32RL(PCI)H] ...1
 - First step guide ... 1
 - CD-ROM *1 [API-PAC(W32)] ...1
 - Warranty Certificate ...1
 - Serial number label...1
- *1 The CD-ROM contains the driver software and User's Guide (this guide)

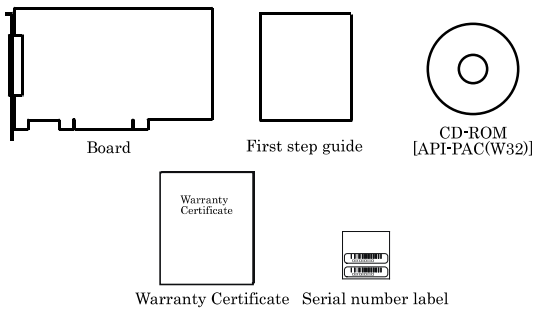

Copyright

Copyright 2013 CONTEC CO., LTD. ALL RIGHTS RESERVED

No part of this document may be copied or reproduced in any form by any means without prior written consent of CONTEC CO., LTD.

CONTEC CO., LTD. makes no commitment to update or keep current the information contained in this document. The information in this document is subject to change without notice.

All relevant issues have been considered in the preparation of this document. Should you notice an omission or any questionable item in this document, please feel free to notify CONTEC CO., LTD.

Regardless of the foregoing statement, CONTEC assumes no responsibility for any errors that may appear in this document or for results obtained by the user as a result of using this product.

Trademarks

MS, Microsoft, Windows, Windows NT and MS-DOS are trademarks of Microsoft Corporation. Other brand and product names are trademarks of their respective holder.

Table of Contents

Check Your Package.....	i
Copyright.....	ii
Trademarks.....	ii
Table of Contents.....	iii

1. BEFORE USING THE PRODUCT	1
------------------------------------	----------

About the Board.....	1
Features.....	1
Support Software.....	2
Cable & Connector (Option).....	3
Accessories (Option).....	4
Customer Support.....	5
Web Site.....	5
Limited Three-Years Warranty.....	5
How to Obtain Service.....	5
Liability.....	5
Safety Precautions.....	6
Safety Information.....	6
Handling Precautions.....	7
Environment.....	8
Inspection.....	8
Storage.....	8
Disposal.....	8

2. SETUP	9
-----------------	----------

What is Setup?.....	9
Using the Board under Windows Using the Driver Library API-PAC(W32).....	9
Using the Board under Windows Using Software Other than the Driver Library API-PAC(W32).....	9
Using the Board under an OS Other than Windows.....	10
Step 1 Installing the Software.....	11
About the driver to be used.....	11
Starting the Install Program.....	12
Select API-DIO(WDM).....	13
Select API-DIO(98/PC).....	14
Step 2 Setting the Hardware.....	16
Parts of the Board and Factory Defaults.....	16
Setting the Board ID.....	17
Plugging the Board.....	18
Step 3 Installing the Hardware.....	19

Turning on the PC.....	19
When Using API-DIO(WDM).....	19
When Using API-DIO(98/PC).....	22
Step 4 Initializing the Software.....	25
When Using API-DIO(WDM).....	25
When Using API-DIO(98/PC).....	27
Updating the Settings.....	27
Step 5 Checking Operations with the Diagnosis Program.....	28
What is the Diagnosis Program?.....	28
Check Method.....	28
Using the Diagnosis Program.....	29
Setup Troubleshooting.....	33
Symptoms and Actions.....	33
If your problem cannot be resolved.....	33

3.	EXTERNAL CONNECTION	35
-----------	----------------------------	-----------

Using the On-board Connectors.....	35
Connecting a Device to a Connector.....	35
Connector Pin Assignment.....	36
Relationships between API-PAC(W32) Logical Ports/Bits and Connector Signal Pins.....	37
Connecting Input Signals.....	38
Input Circuit.....	38
Connecting a Switch.....	38
Output Circuit.....	39
Output Circuit.....	39
Connection to the LED.....	40

4.	FUNCTION	41
-----------	-----------------	-----------

Data I/O Function.....	41
Data Input.....	41
Data Output.....	41
Monitoring Output Data.....	41
Digital Filter Function.....	42
Digital Filter Function Principle.....	42
Set Digital Filter Time.....	42
Interrupt Control Function.....	43
Disabling/enabling Interrupts.....	43
Selecting the Edge of input signals, at which to generate an interrupt.....	43
Clearing the Interrupt Status and Interrupt Signal.....	44

5.	ABOUT SOFTWARE	45
-----------	-----------------------	-----------

CD-ROM Directory Structure.....	45
---------------------------------	----

About Software for Windows.....	46
Accessing the Help File.....	46
Using Sample Programs.....	46
Uninstalling the Driver Libraries.....	48
About Software for Linux.....	51
Driver Software Install Procedure.....	51
Accessing the Help File.....	52
Using Sample Programs.....	52
Uninstalling the driver.....	52

6.	ABOUT HARDWARE	53
----	----------------	----

For detailed technical information.....	53
Hardware specification.....	53
Block Diagram.....	55

1. Before Using the Product

This chapter provides information you should know before using the product.

About the Board

This board is a PCI bus-compliant interface board for input/output of digital signals.

The board is a reverse-common typed and insulated digital input/output board and can input and output digital signals at 12 - 24VDC.

PIO-32/32RL(PCI)H can input and output up to 32 channels.

This product uses opto-coupler isolated input (ready to accept current sinking output signals) for input and opto-coupler isolated current sinking output for output.

Windows/Linux driver is bundled with this product.

Features

- A different external power supply can be used for each common pin as it is shared by 16 channels.
- The PCI bus (personal computer) and the I/O interface are isolated from each other by an opto-coupler, offering good noise immunity.
- You can use 32 signal channels of the input signals as interrupt inputs. You can also select the interrupt trigger edge of the input signal.
- The board has a digital filter feature to prevent wrong recognition of input signals from carrying noise or a chattering.
- Up to 35VDC, 100mA per signal, max. output.
- Zener diode connected to output transistors for protection from surge voltage. Overcurrent protective device provided for every eight channels of output transistors.

Support Software

You should use CONTEC support software according to your purpose and development environment.

Windows version of digital I/O driver **API-DIO(WDM) / API-DIO(98/PC)**

[Stored on the bundled CD-ROM driver library API-PAC(W32)]

The API-DIO(WDM) / API-DIO(98/PC) is the Windows version driver library software that provides products in the form of Win32 API functions (DLL). Various sample programs such as Visual Basic and Visual C++, etc and diagnostic program useful for checking operation is provided.

< Operating environment >

OS Windows 7, Vista, XP, Server 2003, 2000

Adaptation language Visual Basic, Visual C++, Visual C#, Delphi, C++ Builder

You can download the updated version from the CONTEC's Web site (<http://www.contec.com/apipac/>). For more details on the supported OS, applicable language and new information, please visit the CONTEC's Web site.

Linux version of digital I/O driver **API-DIO(LNX)**

[Stored on the bundled CD-ROM driver library API-PAC(W32)]

The API-DIO(LNX) is the Linux version driver software which provides device drivers (modules) by shared library and kernel version. Various sample programs of gcc are provided.

< Operating environment >

OS RedHatLinux, TurboLinux

(For details on supported distributions, refer to Help available after installation.)

Adaptation language gcc

You can download the updated version from the CONTEC's Web site (<http://www.contec.com/apipac/>). For more details on the supported OS, applicable language and new information, please visit the CONTEC's Web site.

Data acquisition VI library for LabVIEW **VI-DAQ** (Available for downloading (free of charge) from the CONTEC web site.)

This is a VI library to use in National Instruments LabVIEW.

VI-DAQ is created with a function form similar to that of LabVIEW's Data Acquisition VI, allowing you to use various devices without complicated settings.

See <http://www.contec.com/vidaq/> for details and download of VI-DAQ.

Cable & Connector (Option)

Shield Cable with 96-Pin Half-Pitch Connector at Both Ends (Mold Type)	: PCB96PS-0.5P (0.5m)
	: PCB96PS-1.5P (1.5m)
	: PCB96PS-3P (3m)
	: PCB96PS-5P (5m)
Shield Cable with 96-Pin Half-Pitch Connector at Both Ends	: PCB96PS-0.5 (0.5m)
	: PCB96PS-1.5 (1.5m)
	: PCB96PS-3 (3m)
	: PCB96PS-5 (5m)
Flat Cable with 96-Pin Half-Pitch Connectors at Both Ends	: PCB96P-1.5 (1.5m)
	: PCB96P-3 (3m)
	: PCB96P-5 (5m)
Shield Cable with 96-Pin Half-Pitch Connector at One End (Mold Type)	: PCA96PS-0.5P (0.5m)
	: PCA96PS-1.5P (1.5m)
	: PCA96PS-3P (3m)
	: PCA96PS-5P (5m)
Shield Cable with 96-Pin Half-Pitch Connector at One End	: PCA96PS-0.5 (0.5m)
	: PCA96PS-1.5 (1.5m)
	: PCA96PS-3 (3m)
	: PCA96PS-5 (5m)
Flat Cable with 96-Pin Half-Pitch Connector at One End	: PCA96P-1.5 (1.5m)
	: PCA96P-3 (3m)
	: PCA96P-5 (5m)
Distribution Shield Cable with 96-Pin Half-Pitch Connector (96Pin→37Pin x 2)	: PCB96WS-1.5P (1.5m)
	: PCB96WS-3P (3m)
	: PCB96WS-5P (5m)
Connector with 96-Pin Half-Pitch Female Set(5 Pieces)	: CN5-H96F

Accessories (Option)

Screw Terminal (M3 x 96P)	: EPD-96A *1*4
Screw Terminal (M3.5 x 96P)	: EPD-96 *1
Screw Terminal (M3 x 96)	: DTP-64A *1
Screw Terminal (M3 x 37P)	: EPD-37A *2*4
Screw Terminal (M3.5 x 37P)	: EPD-37 *2
Connection Conversion Board (96-Pin → 37-Pin x 2)	: CCB-96 *3

*1 A PCB96P or PCB96PS optional cable is required separately.

*2 A PCB96WS optional cable is required separately.

*3 Option cable PCB96P or PCB96PS, and the cable for 37-pin D-SUB are required separately.

*4 "Spring-up" type terminal is used to prevent terminal screws from falling off.

* Check the CONTEC's Web site for more information on these options.

Customer Support

CONTEC provides the following support services for you to use CONTEC products more efficiently and comfortably.

Web Site

Japanese <http://www.contec.co.jp/>
English <http://www.contec.com/>
Chinese <http://www.contec.com.cn/>

Latest product information

CONTEC provides up-to-date information on products.

CONTEC also provides product manuals and various technical documents in the PDF.

Free download

You can download updated driver software and differential files as well as sample programs available in several languages.

Note! For product information

Contact your retailer if you have any technical question about a CONTEC product or need its price, delivery time, or estimate information.

Limited Three-Years Warranty

CONTEC products are warranted by CONTEC CO., LTD. to be free from defects in material and workmanship for up to three years from the date of purchase by the original purchaser.

Repair will be free of charge only when this device is returned freight prepaid with a copy of the original invoice and a Return Merchandise Authorization to the distributor or the CONTEC group office, from which it was purchased.

This warranty is not applicable for scratches or normal wear, but only for the electronic circuitry and original products. The warranty is not applicable if the device has been tampered with or damaged through abuse, mistreatment, neglect, or unreasonable use, or if the original invoice is not included, in which case repairs will be considered beyond the warranty policy.

How to Obtain Service

For replacement or repair, return the device freight prepaid, with a copy of the original invoice. Please obtain a Return Merchandise Authorization number (RMA) from the CONTEC group office where you purchased before returning any product.

* No product will be accepted by CONTEC group without the RMA number.

Liability

The obligation of the warrantor is solely to repair or replace the product. In no event will the warrantor be liable for any incidental or consequential damages due to such defect or consequences that arise from inexperienced usage, misuse, or malfunction of this device.

Safety Precautions

Understand the following definitions and precautions to use the product safely.

Safety Information

This document provides safety information using the following symbols to prevent accidents resulting in injury or death and the destruction of equipment and resources. Understand the meanings of these labels to operate the equipment safely.

⚠ DANGER	DANGER indicates an imminently hazardous situation which, if not avoided, will result in death or serious injury.
⚠ WARNING	WARNING indicates a potentially hazardous situation which, if not avoided, could result in death or serious injury.
⚠ CAUTION	CAUTION indicates a potentially hazardous situation which, if not avoided, may result in minor or moderate injury or in property damage.

Handling Precautions

DANGER

Do not use the product where it is exposed to flammable or corrosive gas. Doing so may result in an explosion, fire, electric shock, or failure.

CAUTION

- There are switches and jumpers on the board that need to be set in advance.
Be sure to check these before installing to the expansion slot.
 - Only set the switches and jumpers on the board to the specified settings.
Otherwise, the board may malfunction, overheat, or cause a failure.
 - Do not strike or bend the board.
Otherwise, the board may malfunction, overheat, cause a failure or breakage.
 - Do not touch the board's metal plated terminals (edge connector) with your hands.
Otherwise, the board may malfunction, overheat, or cause a failure.
If the terminals are touched by someone's hands, clean the terminals with industrial alcohol.
 - Do not install or remove the board to or from the expansion slot while the computer's power or expansion unit is turned on.
Otherwise, the board may malfunction, overheat, or cause a failure.
Be sure that the personal computer power is turned off.
 - Make sure that your PC or expansion unit can supply ample power to all the boards installed.
Insufficiently energized boards could malfunction, overheat, or cause a failure.
 - The specifications of this product are subject to change without notice for enhancement and quality improvement.
Even when using the product continuously, be sure to read the manual and understand the contents.
 - Do not modify the product. CONTEC will bear no responsibility for any problems, etc., resulting from modifying this product.
 - Regardless of the foregoing statements, CONTEC is not liable for any damages whatsoever (including damages for loss of business profits) arising out of the use or inability to use this CONTEC product or the information contained herein.
-

Environment

Use this product in the following environment. If used in an unauthorized environment, the board may overheat, malfunction, or cause a failure.

Operating temperature

0 - 50°C

Operating humidity

10 - 90%RH (No condensation)

Corrosive gases

None

Floating dust particles

Not to be excessive

Inspection

Inspect the product periodically as follows to use it safely.

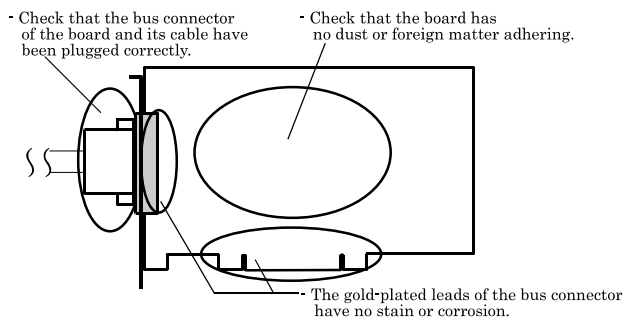

Storage

When storing this product, keep it in its original packing form.

- (1) Put the board in the storage bag.
- (2) Wrap it in the packing material, then put it in the box.
- (3) Store the package at room temperature at a place free from direct sunlight, moisture, shock, vibration, magnetism, and static electricity.

Disposal

When disposing of the product, follow the disposal procedures stipulated under the relevant laws and municipal ordinances.

2. Setup

This chapter explains how to set up the board.

What is Setup?

Setup means a series of steps to take before the product can be used.

Different steps are required for software and hardware.

The setup procedure varies with the OS and software used.

Using the Board under Windows

Using the Driver Library API-PAC(W32)

This section describes the setup procedure to be performed before you can start developing application programs for the board using the bundled CD-ROM “Driver Library API-PAC(W32)”.

Taking the following steps sets up the software and hardware. You can use the diagnosis program later to check whether the software and hardware function normally.

Step 1 Installing the Software

Step 2 Setting the Hardware

Step 3 Installing the Hardware

Step 4 Initializing the Software

Step 5 Checking Operations with the Diagnosis Program

If Setup fails to be performed normally, see the “Setup Troubleshooting” section at the end of this chapter.

Using the Board under Windows

Using Software Other than the Driver Library

API-PAC(W32)

For setting up software other than API-PAC(W32), refer to the manual for that software. See also the following parts of this manual as required.

This chapter Step 2 Setting the Hardware

This chapter Step 3 Installing the Hardware

Chapter 3 External Connection

Chapter 6 About Hardware

Using the Board under an OS Other than Windows

For using the board under Linux, see the following parts of this manual.

This chapter Step 2 Setting the Hardware

Chapter 3 External Connection

Chapter 5 About Software

Chapter 6 About Hardware

For using the board under an OS such as MS-DOS other than Windows, see the following parts of this manual.

This chapter Step 2 Setting the Hardware

Chapter 3 External Connection

Chapter 6 About Hardware

Step 1 Installing the Software

This section describes how to install the Driver libraries.

Before installing the hardware on your PC, install the Driver libraries from the bundled API-PAC (W32) CD-ROM.

The following description assumes the operating system as Windows XP. Although some user interfaces are different depending on the OS used, the basic procedure is the same.

About the driver to be used

Two digital I/O drivers are available : API-DIO(WDM) and API-DIO(98/PC).

API-DIO(WDM) is a new driver to perform digital I/O under Windows.

API-DIO(WDM) was developed to improve the conventional product version of API-DIO(98/PC) in the ease of use and functionality.

It is advisable to use API-DIO(WDM) for you to use an digital I/O device. API-DIO(WDM) will support new OS and devices in the future but will not support Windows NT 4.0, Windows 95, ISA bus.

Use API-DIO(98/PC) if your operating environment contains such an unsupported piece of software or hardware.

Check the following selection guide to easily select the driver to be used.

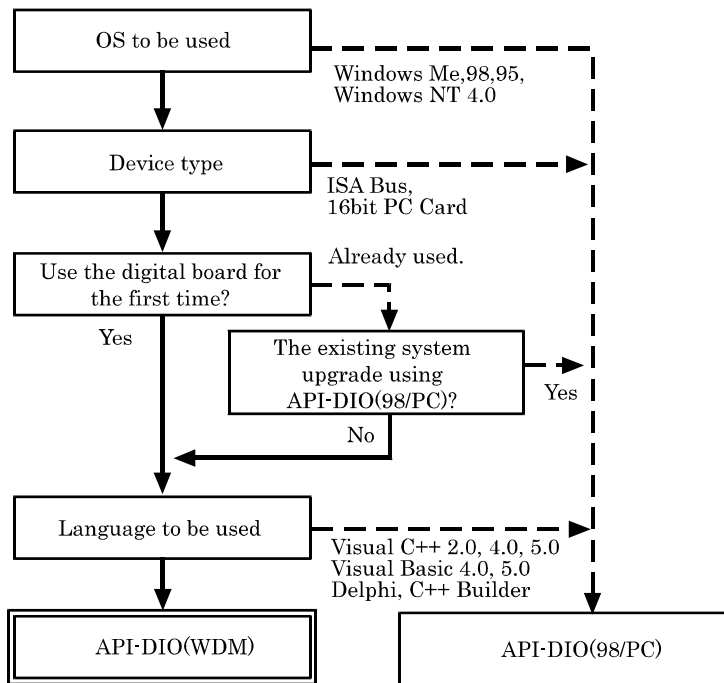

Starting the Install Program

- (1) Load the CD-ROM [API-PAC(W32)] on your PC.
- (2) The API-PAC(W32) Installer window appears automatically.
If the panel does not appear, run (CD-ROM drive letter):\AUTORUN.exe.
- (3) Click on the [Install Development or Execution Environment] button.

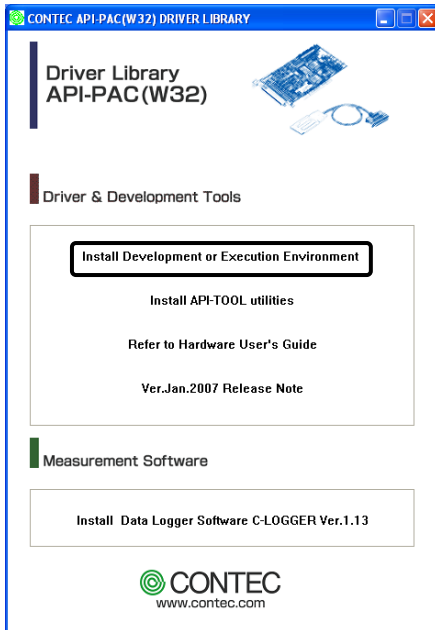

* When using the Windows 7, Vista, driver is automatically installed.

CAUTION

Before installing the software in Windows 7, Vista, XP, Server 2003 and 2000, log in as a user with administrator privileges.

Select API-DIO(WDM)

Selecting API-DIO(WDM)

- (1) The following dialog box appears to select “Driver to install” and “Install option”, “Usage of driver library”.
- (2) Select the "Advanced Digital I/O driver".
- (3) Click on the [Install] button.

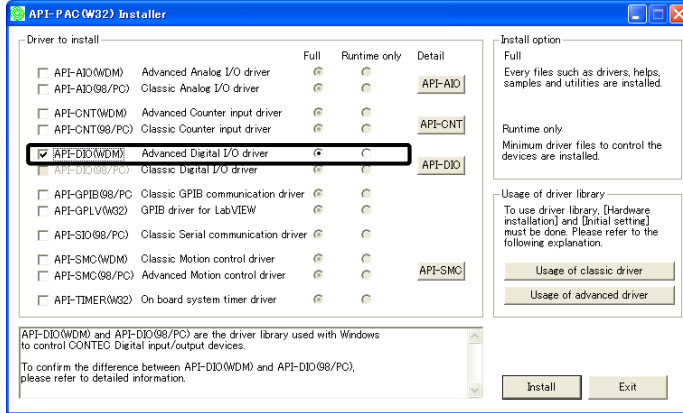

- * Clicking the [API-DIO] button displays detailed information about API-DIO(WDM) and API-DIO(98/PC).

Run the installation

- (1) Complete the installation by following the instructions on the screen.
- (2) The Readme file appears when the installation is complete.

Select API-DIO(98/PC)

Selecting API-DIO(98/PC)

- (1) The following dialog box appears to select “Driver to install” and “Install option”, “Usage of driver library”.
- (2) Select “Classic Digital I/O driver”.
- (3) Click on the [Install] button.

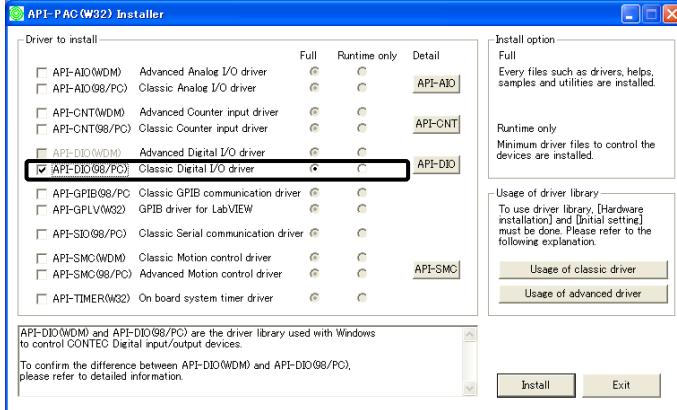

- * Clicking on the [API-DIO] button displays detailed information on API-DIO(WDM), API-DIO(98/PC).

Executing the Installation

- (1) **Follow the on-screen instructions to proceed to install.**
- (2) When the required files have been copied, the “Perform a hardware setup now(API-TOOL Configuration)” and “Showreadme file” check boxes are displayed.

When you are installing the software or hardware for the first time:

1) Uncheck “Perform a hardware setup now”.

2) Click on the [Finish] button.

Go to Step 2 to set and plug the hardware.

* When the hardware has already been installed:

Check “Perform a hardware setup now(API-TOOL Configuration)”, then go to Step 4 “Initializing the Software”.

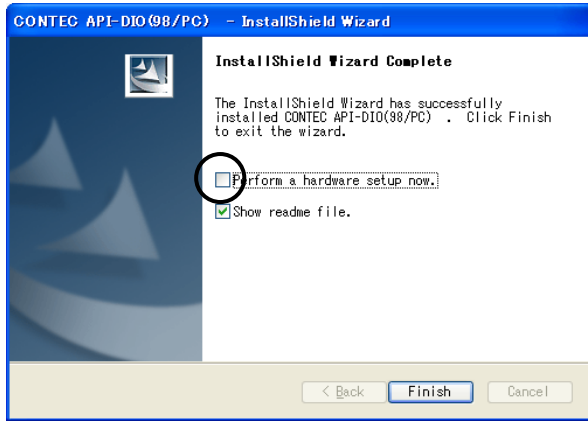

You have now finished installing the software.

Step 2 Setting the Hardware

This section describes how to set the board and plug it on your PC.

The board has some switches and jumper to be preset.

Check the on-board switches and jumpers before plugging the board into an expansion slot.

The board can be set up even with the factory defaults untouched. You can change board settings later.

Parts of the Board and Factory Defaults

Figure 2.1. shows the names of major parts on the board.

Note that the switch setting shown below is the factory default.

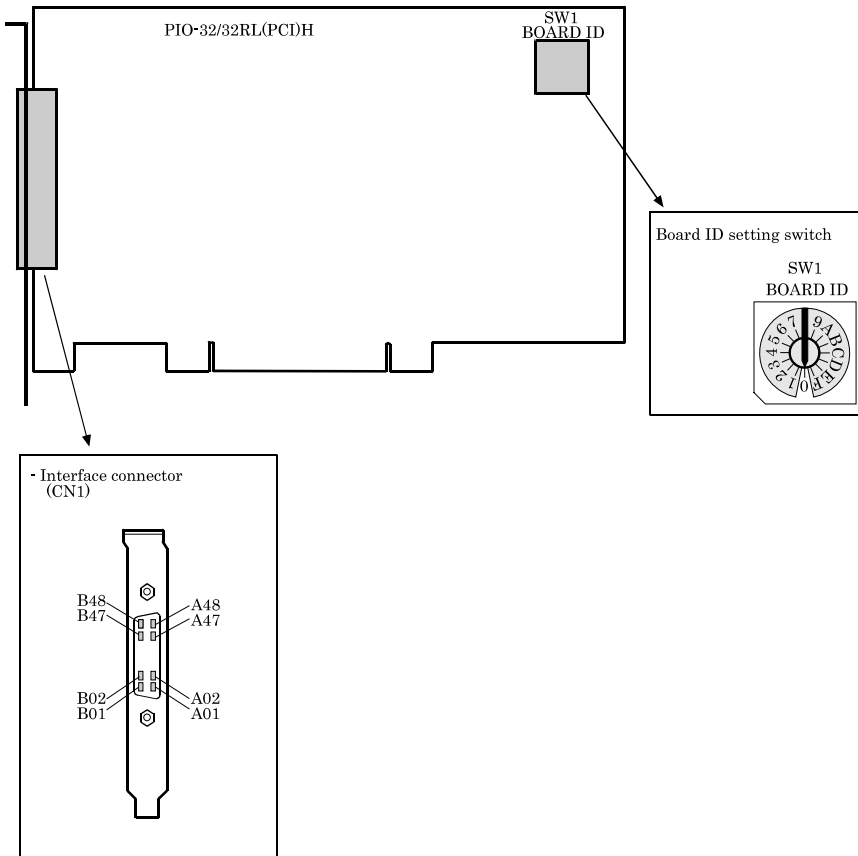

Figure 2.1. Component Locations

Setting the Board ID

If you install two or more boards on one personal computer, assign a different ID value to each of the boards to distinguish them.

The board IDs can be set from 0 - Fh to identify up to sixteen boards.

If only one board is used, the original factory setting (Board ID = 0) should be used.

Setting Procedure

To set the board ID, use the rotary switch on the board. Turn the SW1 knob to set the board ID as shown below.

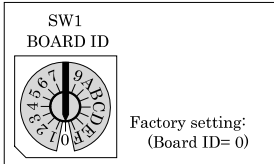

Figure 2.2. Board ID Settings (SW1)

Plugging the Board

- (1) Before plugging the board, shut down the system, unplug the power cord of your PC.
- (2) Remove the cover from the PC so that the board can be mounted.
- (3) Plug the board into an expansion slot.
- (4) Attach the board bracket to the PC with a screw.
- (5) Put the cover back into place.



Applicable PCI bus slots

PCI bus slots used in PCs have keys to prevent 5V and 3.3V PCI bus boards from being accidentally plugged into wrong bus slots. This board can be plugged into both of the 5V and 3.3V PCI bus slots.

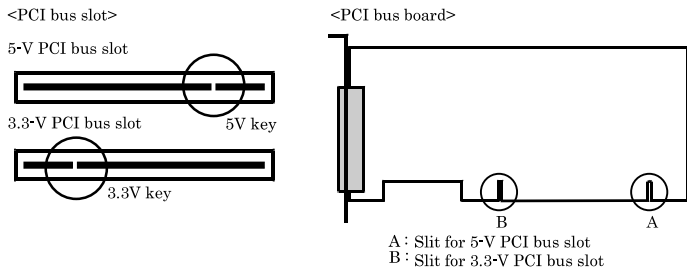

CAUTION

- Do not touch the board's metal plated terminals (edge connector) with your hands. Otherwise, the board may malfunction, overheat, or cause a failure. If the terminals are touched by someone's hands, clean the terminals with industrial alcohol.
- Do not install or remove the board to or from the slot while the computer's power or expansion unit is turned on. Otherwise, the board may malfunction, overheat, or cause a failure. Be sure that the personal computer power is turned off.
- Make sure that your PC or expansion unit can supply ample power to all the boards installed. Insufficiently energized boards could malfunction, overheat, or cause a failure.
- Power supply from the PCI bus slot at +5V is required.

Step 3 Installing the Hardware

For using an expansion board under Windows, you have to let the OS detect the I/O addresses and interrupt level to be used by the board. The process is referred to as installing the hardware.

In the case of using two or more boards, make sure you install one by one with the Found New Hardware Wizard.

Turning on the PC

Turn on the power to your PC.

CAUTION

- The board cannot be properly installed unless the resources (I/O addresses and interrupt level) for the board can be allocated. Before attempting to install the board, first determine what PC resources are free to use.
- The resources used by each PCI bus board do not depend on the location of the PCI bus slot or the board itself. If you remove two or more boards that have already been installed and then remount one of them on the computer, it is unknown that which one of the sets of resources previously assigned to the two boards is assigned to the remounted board. In this case, you must check the resource settings.

When Using API-DIO(WDM)

(1) The “Found New Hardware Wizard” will be started.



Select “No, not this time” and then click the “Next” button.

- (2) When “Multimedia Controller” is displayed, select “Install from a list or specific location [Advanced]” and then specify that folder on the CD-ROM which contains the setup information (INF) file to register the board.



When the model name of hardware is displayed, select “Install the software automatically [Recommended]” and then click on the “Next” button.

Source folder

The setup information (INF) file is contained in the following folder on the bundled CD-ROM.

Windows 7 [64, 32bit], Vista [64, 32bit], XP [64, 32bit],

Server 2003 [64, 32bit], 2000 \INF\Wdm\Dio

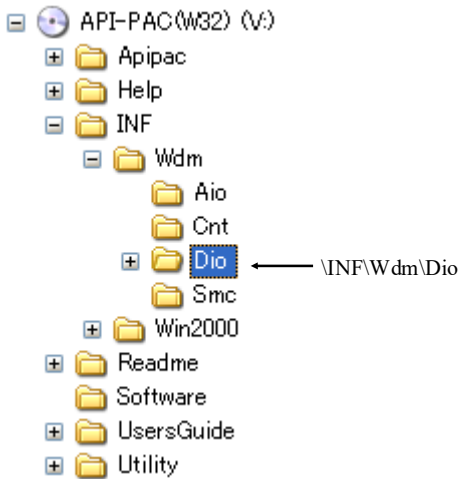



You have now finished installing the hardware.

When Using API-DIO(98/PC)

(1) The “FoundNewHardware Wizard” will be started.



Select “No, not this time” and then click the “Next” button.

(2) Select “Install from a list or specific location[Advanced]” and then click the “Next” button.

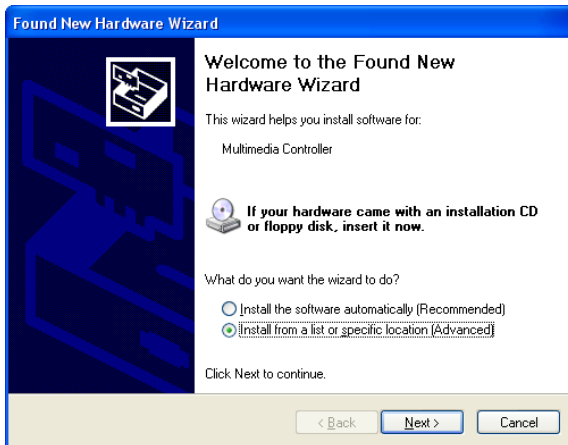

- (3) Specify that folder on the CD-ROM which contains the setup information (INF) file to register the board.

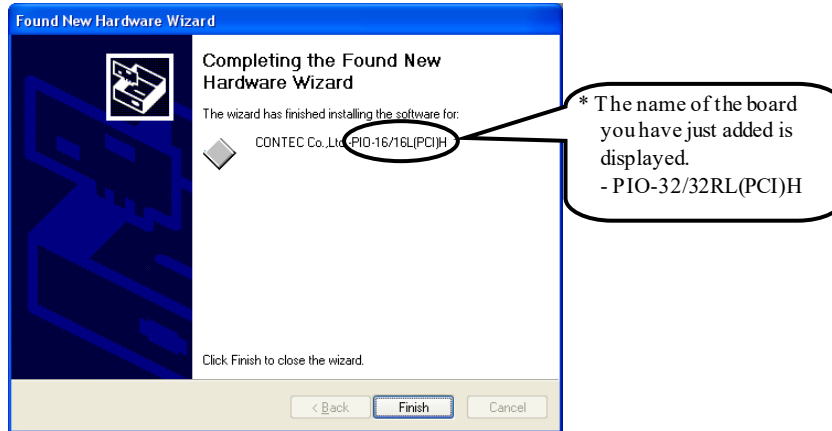

Source folder

The setup information (INF) file is contained in the following folder on the bundled CD-ROM.

Windows 7 [32bit], Vista [32bit], XP [32bit],
Server 2003 [32bit], 2000 \INF\Win2000\Dio\PCI

Example of specifying the folder for use under Windows XP

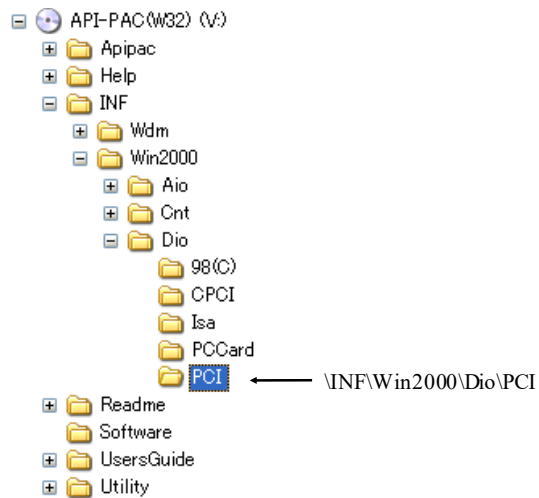

CAUTION

In Windows XP, the Hardware Wizard displays the following alert dialog box when you have located the INF file. This dialog box appears, only indicating that the relevant driver has not passed Windows Logo testing, and it can be ignored without developing any problem with the operation of the board.

In this case, click on the [Continue Anyway] button.

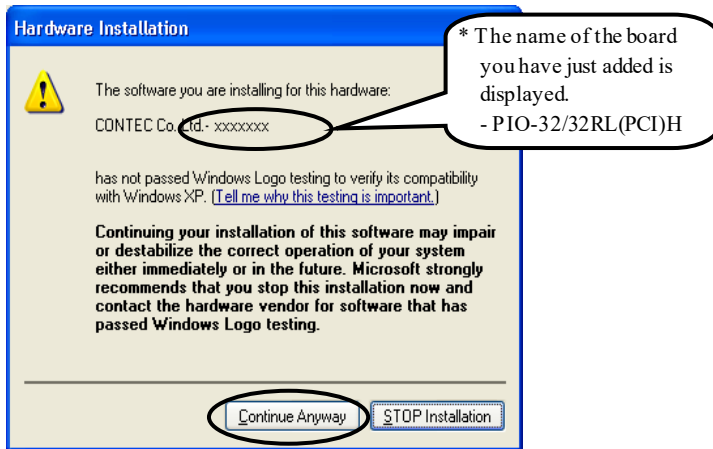

You have now finished installing the software.

Step 4 Initializing the Software

The driver library requires the initial setting to recognize the execution environment. It is called the initialization of the Driver library.

When Using API-DIO(WDM)

API-DIO(WDM) is initialized automatically during hardware installation. Therefore, if you want to use it with its initial settings, you can skip the setting procedure described in Step 4. To change the device name, follow the setting procedure shown below.

Setting the device name

- (1) Run Device Manager. From [My Computer] - [Control Panel], select [System] and then select the [Device Manager] tab.
(You can also open Device Manager by right clicking on My Computer and selecting Properties.)

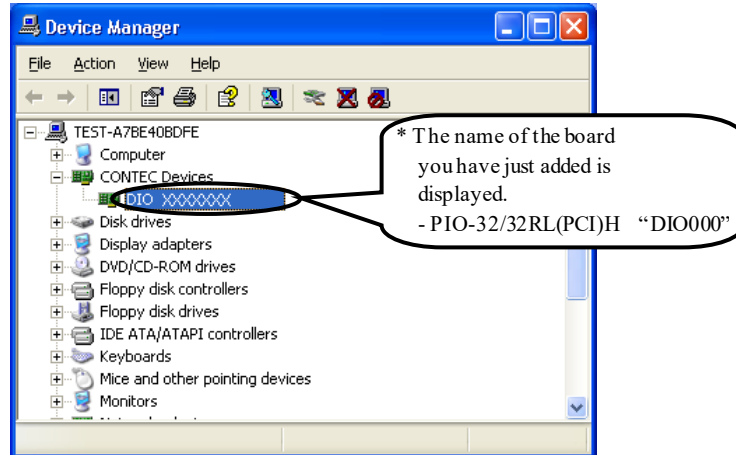

- (2) The installed hardware appears under the CONTEC Devices node. Open the CONTEC Devices node and select the device you want to setup (the device name should appear highlighted). Click [Properties].

- (3) The property page for the device opens.
Enter the device name in the common settings tab page and then click [OK].
The device name you set here is used later when programming.

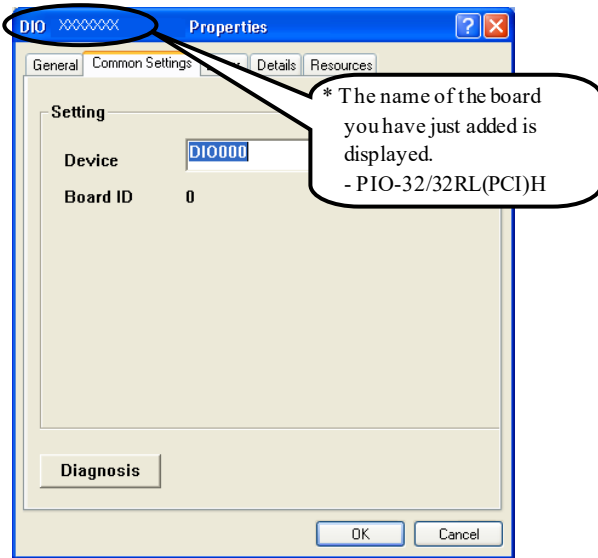

- * The initial device name that appears is a default value. You can use this default name if you wish.
- * Make sure that you do not use the same name for more than one device.

You have now finished installing the initial setting of Software.

When Using API-DIO(98/PC)

- (1) Open the Start Menu, then select “Programs” – “CONTEC API-PAC(W32)” – “API-TOOL Configuration”.

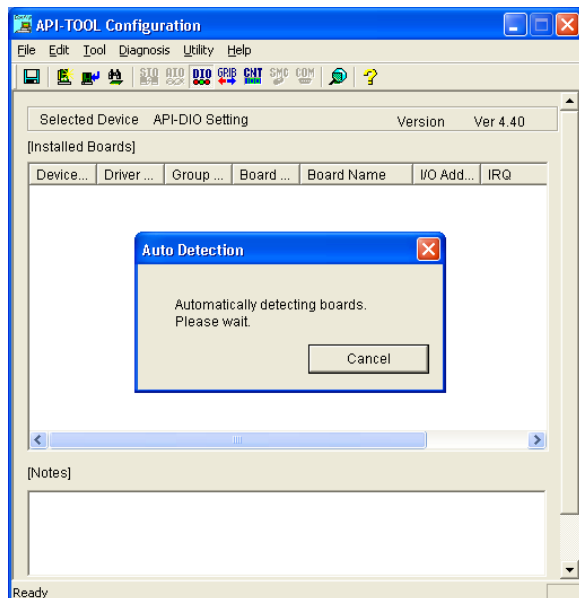

- (2) API-TOOL Configuration detects hardware automatically.
The detected boards are listed.

Updating the Settings

- (1) Select “Save settings to registry...” from the “File” menu.

You have now finished installing the initial setting of Software.

Step 5 Checking Operations with the Diagnosis Program

Use the diagnosis program to check that the board and driver software work normally, thereby you can confirm that they have been set up correctly.

What is the Diagnosis Program?

The diagnosis program diagnoses the states of the board and driver software.

It can also be used as a simple checker when an external device is actually connected.

Using the “Diagnosis Report” feature reports the driver settings, the presence or absence of the board, I/O status, and interrupt status.

Check Method

Connect the board to a remote device to test the input/output and check the execution environment.

For this board, prepare an external power supply (12 - 24V).

To connect the external device, see Chapter 3 “External Connection”.

Using the Diagnosis Program

Starting the Diagnosis Program for Use of API-DIO(WDM)

Click the [Diagnosis] button on the device property page to start the diagnosis program.

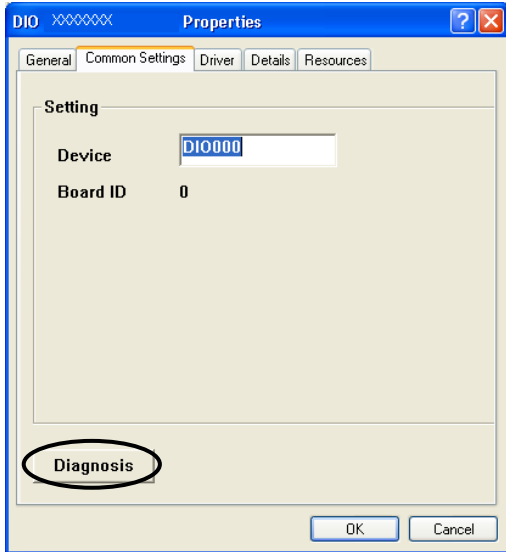

Starting the Diagnosis Program for Use of API-DIO(98/PC)

Select the board in the API-TOOL Configuration windows, then run the Diagnosis Program. Follow the instructions on screen.

* The name of the board you have just added is displayed.

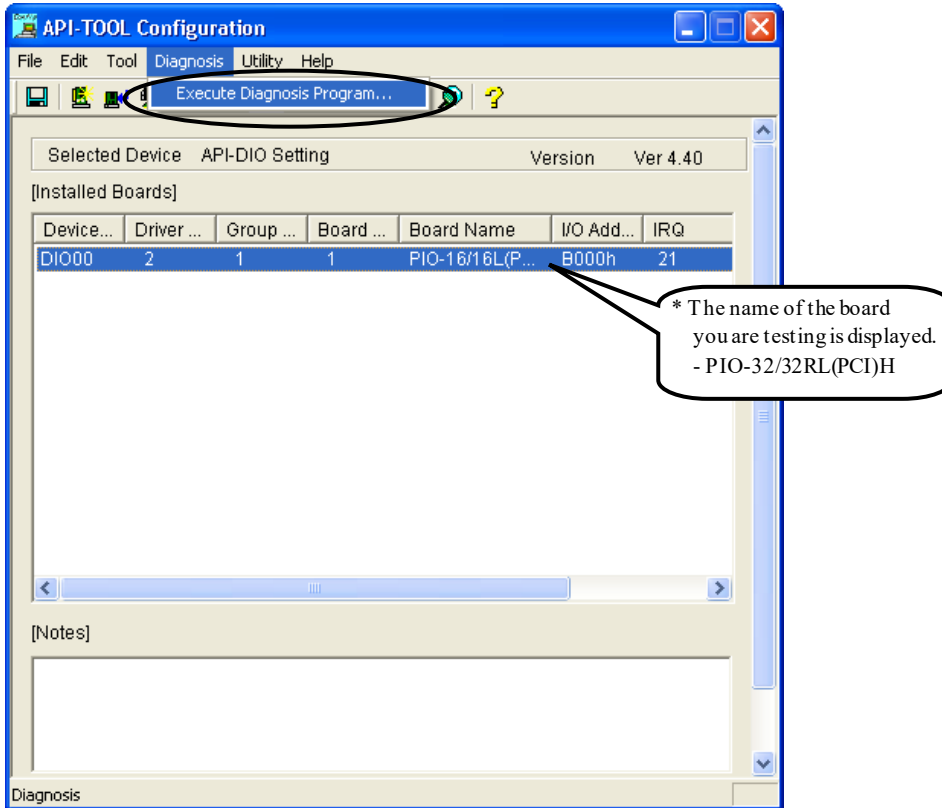

Checking Digital Inputs and Outputs

The main panel of the Diagnosis Program appears.

You can check the current operation states of the board in the following boxes:

“Input Port” : Displays input values bit by bit at fixed time intervals.

“Output Port” : Mouse operation allows the data to output or display.

“Interrupt” : Displays the number of interrupts detected bit by bit.

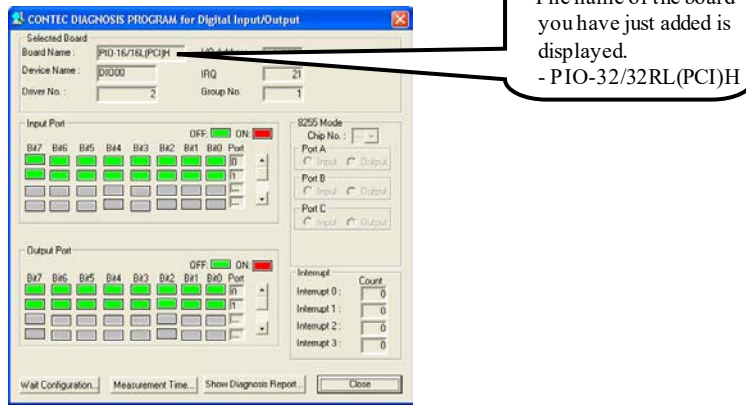

To use the wait time control feature, click on the [Wait Configuration] button. Use the feature when the wait time based on the Dio Wait or Dio WaitEx function is not normal.

To use the function execution time measurement feature, click on the [Measurement Time] button. Enter the I/O start port and the number of ports, then press the measurement button. The time for each execution of a function will be measured.

Diagnosis Report

- (1) Clicking on the [Show Diagnosis Report] button displays detailed data such as board settings and the diagnosis results while saving them in text format.

The results are saved and displayed as a text file (DioRep.txt) in the install folder (Program Files\CONTEC\API-PAC(W32)).

The Diagnosis Program performs “board presence/absence check”, “driver file test”, “board setting test”, and so on.

⚠ CAUTION

Before executing diagnosis report output, unplug the cable from the board.

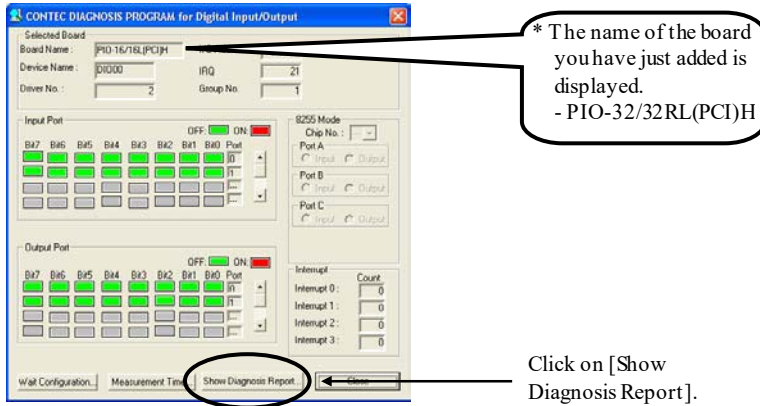

Click on [Show Diagnosis Report].

- (2) A diagnosis report is displayed as shown below.

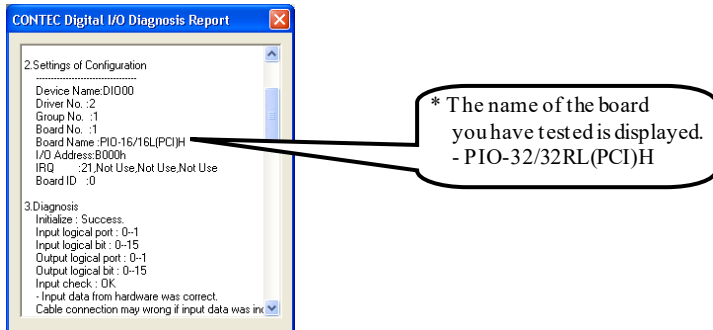

Setup Troubleshooting

Symptoms and Actions

The board cannot be initialized [Windows NT 4.0]

The driver may not yet be activated.

When using the board under an OS not compliant with Plug and Play, such as Windows NT 4.0, make sure that the [PnP OS] BIOS option has been set to [NO], [disable], or [Do not use]. If the option has been set to [Windows 95], for example, the board may not be detected normally. For details on BIOS settings, refer to the user's guide for your PC.

No output can be obtained.

Use API-TOOL Configuration to check whether the board name setting is wrong.

The board works with the Diagnosis Program but not with an application.

The Diagnosis Program is coded with API-TOOL functions. As long as the board operates with the Diagnosis Program, it is to operate with other applications as well. In such cases, review your program while paying attention to the following points:

- Check the arguments to functions and their return values.
- When the board is an isolated type, it has a time lag for its response between the output by a function and the actual output. Consider the execution intervals between functions.

The OS won't normally get started or detect the board.

[Windows 7, Vista, XP, Server 2003, 2000]

Turn off the power to your PC, then unplug the board. Restart the OS and delete the board settings of API-TOOL Configuration. Turn off the PC again, plug the board, and restart the OS. Let the OS detect the board and use API-TOOL Configuration to register board settings.

If your problem cannot be resolved

Contact your retailer.

3. External Connection

This chapter describes the interface connectors on the board and the external I/O circuits. Check the information available here when connecting an external device.

Using the On-board Connectors

Connecting a Device to a Connector

To connect an external device to this board, plug the cable from the device into the interface connector shown below.

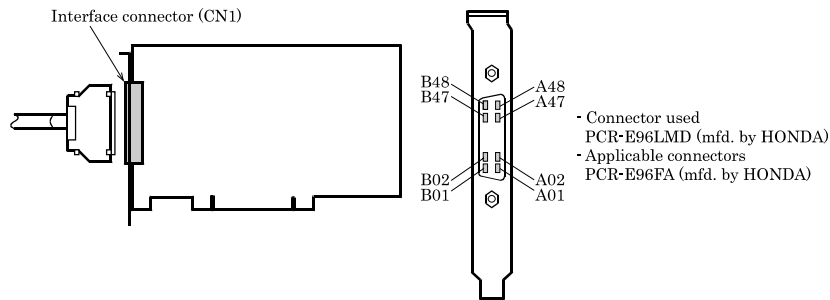

* Please refer to chapter 1 for more information on the supported cable and accessories.

Figure 3.1. Interface Connector and Applicable Cable Connector

Connector Pin Assignment

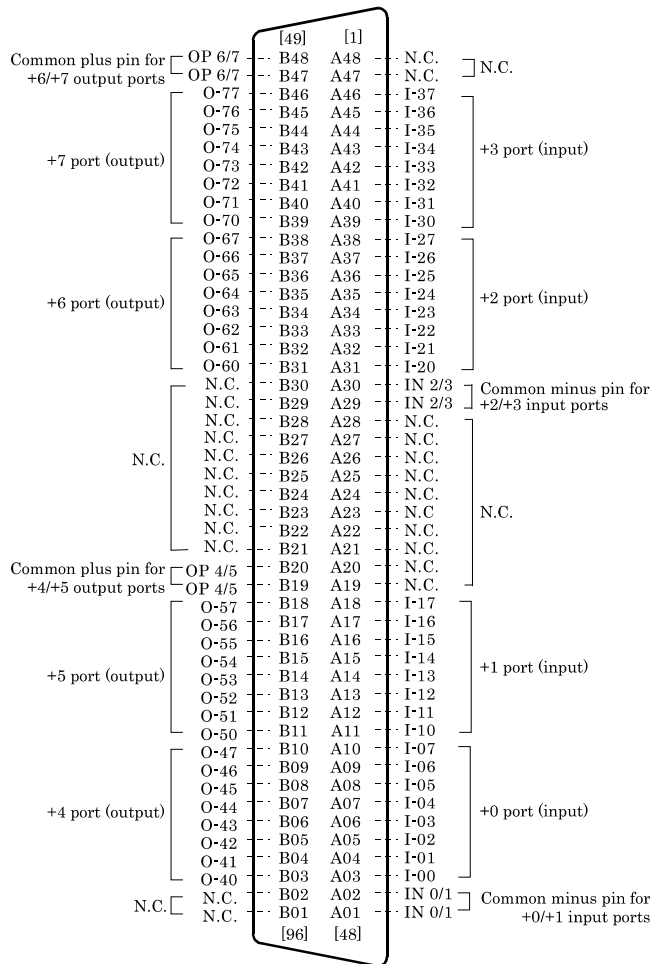

* I-00 - I-37 can be used as interrupt signal.

The numbers in square brackets [] are pin numbers designated by HONDA TSUSHIN KOGYO CO., LTD.

I-00 - I-37	32 input signal pins. Connect output signals from the external device to these pins.
O-40 - O-77	32 output signal pins. Connect these pins to the input signal pins of the external device.
OP 4/5 - OP 6/7	Connect the positive side of the external power supply. These pins are common to 16 output signal pins.
IP 0/1 - IP 2/3	Connect the positive side of the external power supply. These pins are common to 16 input signal pins.
N.C.	This pin is left unconnected.

Figure 3.2. Pin Assignments of Interface Connector

Relationships between API-PAC(W32) Logical Ports/Bits and Connector Signal Pins

The following table lists the relationships between the connector signal pins and the logical port/bit numbers used for I/O functions when applications are written with API-PAC(W32).

Table 3.1. Logical Ports, Logical Bits, and Connector Signal Pins

	D7	D6	D5	D4	D3	D2	D1	D0
Input Logical Ports0	I-07 [7]	I-06 [6]	I-05 [5]	I-04 [4]	I-03 [3]	I-02 [2]	I-01 [1]	I-00 [0]
Input Logical Ports1	I-17 [15]	I-16 [14]	I-15 [13]	I-14 [12]	I-13 [11]	I-12 [10]	I-11 [9]	I-10 [8]
Input Logical Ports2	I-27 [23]	I-26 [22]	I-25 [21]	I-24 [20]	I-23 [19]	I-22 [18]	I-21 [17]	I-20 [16]
Input Logical Ports3	I-37 [31]	I-36 [30]	I-35 [29]	I-34 [28]	I-33 [27]	I-32 [26]	I-31 [25]	I-30 [24]

	D7	D6	D5	D4	D3	D2	D1	D0
Output Logical Ports0	O-47 [7]	O-46 [6]	O-45 [5]	O-44 [4]	O-43 [3]	O-42 [2]	O-41 [1]	O-40 [0]
Output Logical Ports1	O-57 [15]	O-56 [14]	O-55 [13]	O-54 [12]	O-53 [11]	O-52 [10]	O-51 [9]	O-50 [8]
Output Logical Ports2	O-67 [23]	O-66 [22]	O-65 [21]	O-64 [20]	O-63 [19]	O-62 [18]	O-61 [17]	O-60 [16]
Output Logical Ports3	O-77 [31]	O-76 [30]	O-75 [29]	O-74 [28]	O-73 [27]	O-72 [26]	O-71 [25]	O-70 [24]

Note : I-xx represents an input signal; O-xx is an output signal.
[xx] represents a logical bit.

CAUTION

The logical port and logical bit numbers are virtual port and bit numbers that enable programming independent of board I/O addresses or board types.

For details, refer to API-DIO HELP available after installing API-PAC(W32).

Connecting Input Signals

Connect the input signals to a device which can be current-driven, such as a switch or transistor output device.

The connection requires an external power supply to feed currents.

The board inputs the ON/OFF state of the current-driven device as a digital value.

Input Circuit

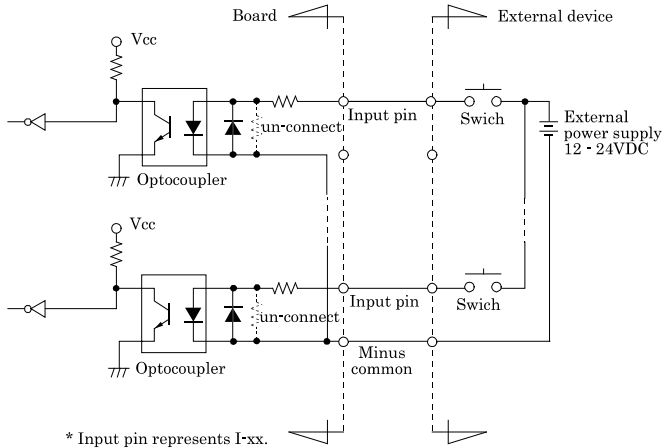
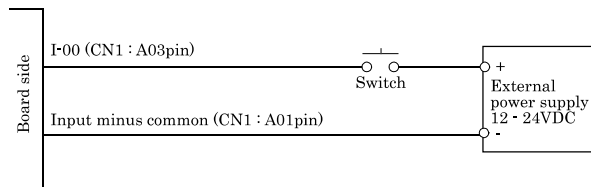

Figure 3.3. Input Circuit

The input circuits of interface blocks of the PIO-32/32RL(PCI)H are illustrated in Figure 3.3.

The signal inputs are isolated by opto-couplers (corresponding to the current source output). The board therefore requires an external power supply to drive the inputs. The power requirement for each input pin is about 5.1 mA at 24VDC (about 2.6mA at 12VDC).

Connecting a Switch



When the switch is ON, the corresponding bit contains 1.

When the switch is OFF, by contrast, the bit contains 0.

Figure 3.4. An Example to use Input I-00

Output Circuit

Connect the output signals to a current-driven controlled device such as a relay or LED.

The connection requires an external power supply to feed currents.

The board controls turning on/off the current-driven controlled device using a digital value.

Output Circuit

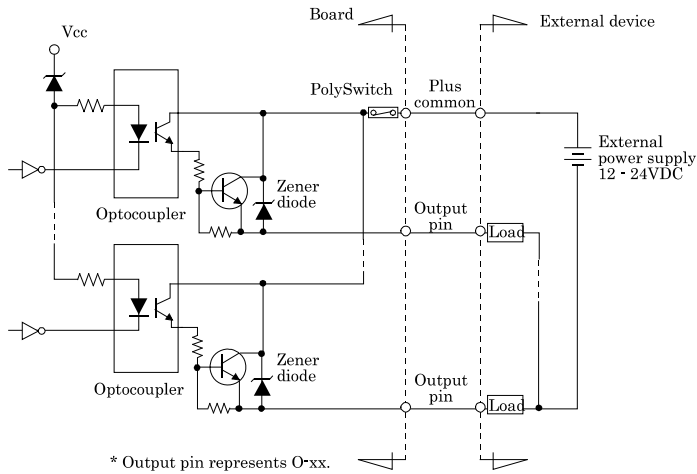

Figure 3.5. Output Circuit

The output circuits of interface blocks of the PIO-32/32RL(PCI)H are illustrated in Figure 3.5. The signal output section is an opto-coupler isolated, current source output type. Driving the output section requires an external power supply.

The rated output current per channel is 100mA at maximum.

A zener diode is connected to the output transistor for protection from surge voltages. A PolySwitch-based overcurrent protector is provided for every eight output transistors. When the overcurrent protector works, the output section of the board is temporarily disabled. If this is the case, turn off the power to the PC and the external power supply and wait for a few minutes, then turn them on back.



CAUTION

When the PC is turned on, all output are reset to OFF.

Connection to the LED

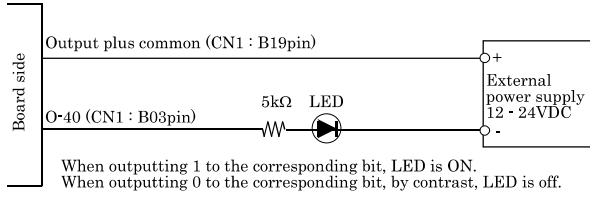

Figure 3.6. An Example to use Output O-40

4. Function

This section describes the features of the board.

Each function described here can be easily set and executed by using the bundled API driver library.
For details, refer to API-DIO HELP available after installation.

Data I/O Function

Data Input

When input data is “ON”, “1” is input to the relevant bit.

When the input data is “OFF”, in contrast, “0” is input to the relevant bit.

Data Output

When “1” is output to the relevant bit, the corresponding transistor is set to “ON”.

When “0” is output to the relevant bit, in contrast, the corresponding transistor is set to “OFF”.



CAUTION

When the PC is turned on, all output are reset to 0 (OFF).

Monitoring Output Data

The PIO-32/32RL(PCI)H can read the state of the data currently being output without affecting the output data.

Digital Filter Function

Using this feature, the PIO-32/32RL(PCI)H can apply a digital filter to every input pin, thereby preventing wrong recognition of input signals from being affected by noise or chattering.

Digital Filter Function Principle

The digital filter checks the input signal level during the sampling time of the clock signal. When the signal level remains the same for the digital filter set time, the digital filter recognizes that signal as the input signal and changes the signal level of the PC.

If the signal level changes at a frequency shorter than the set time, therefore, the level change is ignored.

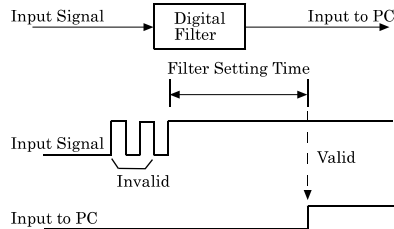

Figure 4.1. Digital Filter Function Principle

Set Digital Filter Time

Set the digital filter time to 0 - 20 (14h).

Setting the digital filter time to 0 disables digital filtering. It is set to 0 when the power is turned on.

Figure 4.2 shows the relationships between the digital filter time and the setting data.

$$\text{Digital Filter Time}[\text{sec.}] = 2^n / (8 \times 10^6)$$

$$n: = \text{setting data}(0 - 20)$$

Setting Data (n)	Digital Filter Time	Setting Data (n)	Digital Filter Time	Setting Data (n)	Digital Filter Time
0 (00h)	The filter function is not used.	7 (07h)	16μsec	14 (0Eh)	2.048msec
1 (01h)	0.25μsec	8 (08h)	32μsec	15 (0Fh)	4.096msec
2 (02h)	0.5μsec	9 (09h)	64μsec	16 (10h)	8.192msec
3 (03h)	1μsec	10 (0Ah)	128μsec	17 (11h)	16.384msec
4 (04h)	2μsec	11 (0Bh)	256μsec	18 (12h)	32.768msec
5 (05h)	4μsec	12 (0Ch)	512μsec	19 (13h)	65.536msec
6 (06h)	8μsec	13 (0Dh)	1.024msec	20 (14h)	131.072msec

Figure 4.2. Digital Filter Time and Setting Data

⚠ CAUTION

- If you set the digital filter time, the filter applies to all input pins. You cannot apply the filter only to a specific input pin.
- Do not set a value outside the above range to the Setting Data as doing so can cause the board to malfunction.

Interrupt Control Function

The PIO-32/32RL(PCI)H can use all of the input signals as interrupt request signals.

The board can generate an interrupt request signal to the PC when the input signal change from High to Low or from Low to High.

When the digital filter (described above) is used, interrupt requests are generated by input signals that have passed through the filter.

Disabling/enabling Interrupts

Interrupt mask bits can be used to disable or enable the individual bits for interruptions.

Once a certain bit has been interrupt-disabled, no interrupt occurs even when the corresponding input signal changes its level.

To let interrupts occur, enable the corresponding interrupt mask bit for interruptions.



CAUTION

All of the interrupt mask bits are interrupt-disabled when the power is turned on.

Selecting the Edge of input signals, at which to generate an interrupt

The input signal edge selection bit can be used to set the input logic for interruption bit by bit.

If you set an input signal edge selection bit to 0, an interrupt occurs when the input value to the corresponding bit changes from 0 to 1 (at the fall of the input signal from High to Low).

If you set an input signal edge selection bit to 1, an interrupt occurs when the input value to the corresponding bit changes from 1 to 0 (at the rise of the input signal from Low to High).



CAUTION

All of the input signal edge selection bits are set to 0 when the power is turned on.

Clearing the Interrupt Status and Interrupt Signal

Interrupt status bits are used to identify the input signal bit being used for requesting an interrupt. When an interrupt status is input, the interrupt request signal and the interrupt status are cleared automatically.

CAUTION

- All of the interrupt status bits are set to 0 when the power is turned on.
 - If an interrupt mask bit has been set to disable interrupts, the interrupt status bit is not set even when the input signal changes its level.
-

5. About Software

CD-ROM Directory Structure

```

\
|—Autorun.exe           Installer Main Window
|  |—Readmej.html       Version information on each API-TOOL (Japanese)
|  |—Readmeu.html       Version information on each API-TOOL (English)
|  .
|  |—APIPAC             Each installer
|  |  |—AIO
|  |  |  |—DISK1
|  |  |  |—DISK2
|  |  |  |—.....
|  |  |  |—DISKN
|  |  |—AioWdm
|  |  |—CNT
|  |  |—DIO
|  |  |—.....
|  .
|  |—HELP               HELP file
|  |  |—Aio
|  |  |—Cnt
|  |  |—.....
|  .
|  |—INF                Each INF file for OS
|  |  |—WDM
|  |  |—Win2000
|  |  |—Win95
|  .
|  |—linux              Linux driver file
|  |  |—cnt
|  |  |—dio
|  |  |—.....
|  .
|  |—Readme             Readme file for each driver
|  .
|  |—Release            Driver file on each API-TOOL
|  |  |—API_NT          (For creation of a user-specific install program)
|  |  |—API_W95
|  .
|  |—UsersGuide         Hardware User's Guide(PDF files)

```

About Software for Windows

The bundled CD-ROM “Driver Library API-PAC(W32)” contains the functions that provide the following features:

- Digital input/output of specified ports
- Hardware digital input/output of specified bits
- Hardware digital filtering that prevents chattering

For details, refer to the help file. The help file provides various items of information such as “Function Reference”, “Sample Programs”, and “FAQs”. Use them for program development and troubleshooting.

Accessing the Help File

- (1) Click on the [Start] button on the Windows taskbar.
- (2) Using the API-DIO(WDM), from the Start Menu, select “Programs” – “CONTEC API-PAC(W32)” – “DIOWDM” - “API-DIO(WDM)HELP” to display help information.
- (3) Using the API-DIO(98/PC), from the Start Menu, select “Programs” – “CONTEC API-PAC(W32)” – “Dio” - “API-DIO HELP” to display help information.

Using Sample Programs

Sample programs have been prepared for specific basic applications.

For the API-DIO(WDM), The sample programs are stored in

\Program Files\CONTEC\API-PAC(W32)\DIOWDM\Sample.

For the API-DIO(98/PC), The sample programs are stored in

\Program Files\CONTEC\API-PAC(W32)\Dio\Samples.

To use each sample program, enter its driver number and group number set by API-TOOL Configuration in the DrvNo and GrpNo fields.

Use these sample programs as references for program development and operation check.

Running a Sample Program

- (2) For the API-DIO(WDM), from the Start Menu, select “Programs” – “CONTEC API-PAC(W32)” – “DIOWDM” – “SAMPLE...”.
- (3) For the API-DIO(98/PC), from the Start Menu, select “Programs” – “CONTEC API-PAC(W32)” – “Dio” – “SAMPLE...”.
- (4) A sample program is invoked.

Sample Programs - Examples

API-DIO(WDM) sample program

- Simple I/O sample program : Input digital data through a specified port.
- Multi ports/bits I/O sample program : Input digital data through a specified multi ports/bits.
- Trigger monitoring sample program : Monitoring rising/falling trigger through a specified board.
- Interrupt sample program : Services interrupts of a specified board.

API-DIO(98/PC) sample program

- Sample program 1 : Inputs digital data through a specified port.
- Sample program 2 : Outputs digital data through a specified port.
- Sample program 3 : Inputs/outputs digital data from/to a programmable board.
- Sample program 4 : Inputs digital data from a specified port in the background.
- Sample program 5 : Inputs/outputs digital data from/to a specified bit.
- Sample program 6 : Services interrupts of a specified board.
- Sample program 7 : Provides process control of a specified board.
- Sample program 8 : Performs trigger monitoring of a specified board.
- Sample program 9 : Inputs digital data through a specified port using BCD data.
- Sample program 10 : Executes digital input (simple functions) at specified bits through a specified port.
- Sample program 11 : Services interrupts of a specified board (using an extended function).
- Sample program (Console): Inputs/outputs digital data through a specified port.

Uninstalling the Driver Libraries

The method used to uninstall API-PAC(W32) differs depending on which OS you are using. Follow the procedure given below.

Uninstall procedure for Windows 7 and Windows Vista

< Uninstalling the device driver >

1. Run Device Manager. From [My Computer] - [Control Panel], select [System] and then select the [Device Manager] tab.
(You can also open Device Manager by right clicking on My Computer and selecting Properties.)
2. All of the hardware that uses the API-TOOL(WDM) driver is registered under the CONTEC Devices tree.
Open the device tree, select the hardware to uninstall, and then right-click the hardware.
From the popup menu, select [Uninstall].

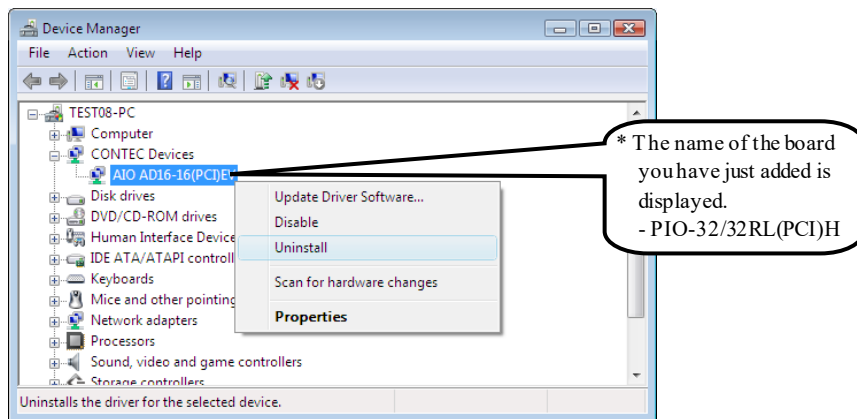

3. A dialog box opens asking you to confirm whether to uninstall. Select the [Delete the driver software for this device] checkbox, and then click [OK].

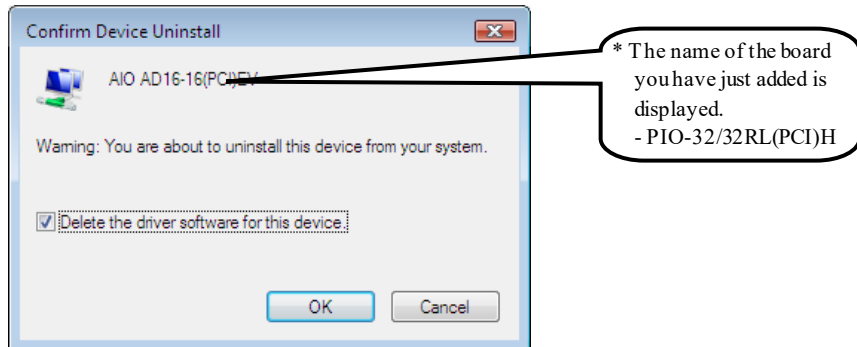

< Uninstall the development environment >

Use [My Computer] - [Control Panel] - [Add and Remove Applications] to uninstall the development environment.

Select [CONTEC API-*** (WDM) VerX.XX (development environment)] and then click [Uninstall].

* "***" contains the driver category name (AIO, CNT, DIO, SMC, etc.).

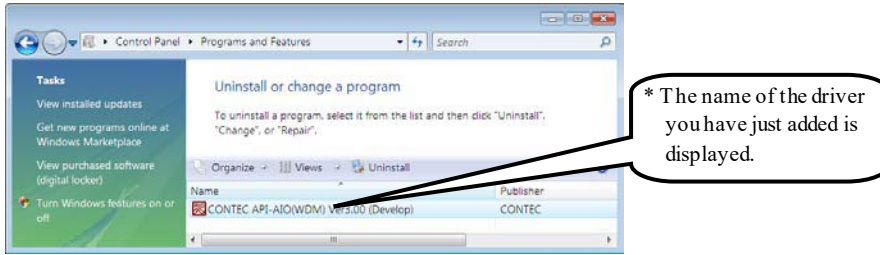

Uninstall procedure for Windows XP and Windows 2003 Server

< Uninstall the device driver >

Use [My Computer] - [Control Panel] - [Add and Remove Applications] to uninstall the device driver.

Select [Windows driver package - CONTEC (***)] and then click [Change/Remove].

* "***" contains the driver category name (caio, ccnt, cdio, csmc, etc.).

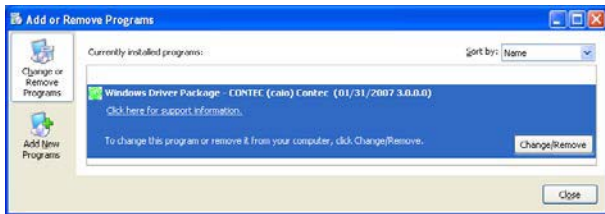

< Uninstall the development environment >

Use [My Computer] - [Control Panel] - [Add and Remove Applications] to uninstall the development environment.

Select [CONTEC API-*** (WDM) VerX.XX (development environment)] and then click [Change/Remove].

* "***" contains the driver category name (AIO, CNT, DIO, SMC, etc.).

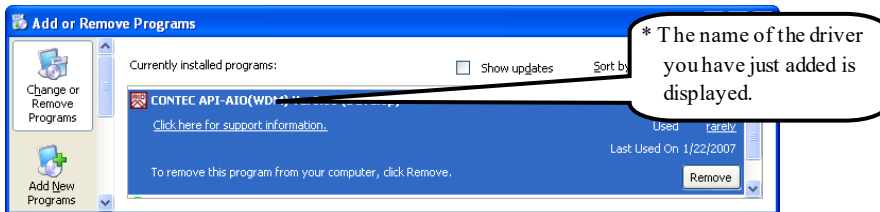

Uninstall procedure for Windows Me

< Uninstall the device driver >

Use [My Computer] - [Control Panel] - [Add and Remove Applications] to uninstall the device driver. Select [CONTEC API-*** (WDM) driver] and then click [Add and Remove Applications].

* "***" contains the driver category name (AIO, CNT, DIO, SMC, etc.).

< Uninstall the development environment >

Use [My Computer] - [Control Panel] - [Add and Remove Applications] to uninstall the development environment.

Select [CONTEC API-*** (WDM) VerX.XX (development environment)] and then click [Add and Remove Applications].

* "***" contains the driver category name (AIO, CNT, DIO, SMC, etc.).

Uninstall procedure for Windows 98, 98SecondEdition

< Uninstall the device driver >

Use [My Computer] - [Control Panel] - [Add and Remove Applications] to uninstall the device driver. Select [CONTEC API-*** (WDM) driver] and then click [Add and Remove Applications].

* "***" contains the driver category name (AIO, CNT, DIO, SMC, etc.).

< Uninstall the development environment >

Use [My Computer] - [Control Panel] - [Add and Remove Applications] to uninstall the development environment.

Select [CONTEC API-*** (WDM) VerX.XX (development environment)] and then click [Add and Remove Applications].

* "***" contains the driver category name (AIO, CNT, DIO, SMC, etc.).

About Software for Linux

The Linux version of digital I/O function driver, API-DIO(LNX), provides functions that execute the following features:

- Digital input/output of specified ports
- Digital input/output of specified bits
- Hardware digital filtering that prevents chattering

For details, refer to the help file. The help file provides various items of information such as “Function Reference”, “Sample Programs”, and “FAQs”. Use them for program development and troubleshooting.

Driver Software Install Procedure

The Linux version for digital I/O driver, API-DIO(LNX), is supplied as a compressed file /linux/dio/cdioXXX.tgz on the bundled API-PAC(W32)CD-ROM. (Note: XXX represents the driver version.)

Mount the CD-ROM as shown below, copy the file to an arbitrary directory, and decompress the file to install the driver.

For details on using the driver, refer to readme.txt and the help file in HTML format extracted by installation.

To install the driver, log in as a superuser.

Decompression and setup procedure

```
# cd
# mount /dev/cdrom /mnt/cdrom           Mount the CD-ROM.
# cp /mnt/cdrom/linux/dio/cdioXXX.tgz ./ Copy the compressed file.
# tar xvfz cdioXXX.tgz                 Decompress the compressed file.
.....
# cd contec/cdio
# make
                                     Compile the file.
.....
# make install                         Install.
.....
# cd config
# ./config                             Set up the board to be used.
..... Set as follows.....
# ./contec_dio_start.sh                Start the driver.
# cd
```

Accessing the Help File

- (1) Invoke a web browser in your X-Window environment.
- (2) In the browser, open diohelp.htm in the the contec/cdio/help directory.

Using Sample Programs

Sample programs have been prepared for specific basic applications.

Sample programs for each language are contained in the contec/cdio/samples directory. For compiling them, refer to the manual for the desired language.

Uninstalling the driver

To uninstall the driver, use the uninstall shell script contained in the contec/cdio directory. For details, check the contents of the script.

6. About Hardware

This chapter provides hardware specifications and hardware-related supplementary information.

For detailed technical information

For further detailed technical information (“Technical Reference” including the information such as an I/O map, configuration register, etc.), visit the Contec's web site (<http://www.contec.com/support/>) to call for it.

Hardware specification

Table 6.1. Specification <1/2>

Item	Specification	
Input		
Input format	Opto-isolated input (corresponding to the current source output)(Positive logic *1)	
Number of input signal channels	32 channels (all available for interrupts) (One common power supply per 16 channels)	
Input resistance	4.7k Ω	
Input ON current	2.0mA or more	
Input OFF current	0.16mA or less	
Interrupt	32 interrupt input signals are arranged into a single output of interrupt signal INTA. An interrupt is generated at the falling edge (HIGH-to-LOW transition) or rising edge (LOW-to-HIGH transition).	
Response time	200 μ sec within	
Output		
Output format	Opto-isolated (Compatible with current source output)(Positive logic *1)	
Number of output signal channels	32 channels (One common power supply per 16 channels)	
Output rating	Output voltage	12 - 24VDC(\pm 10%)
	Output current	100mA (par channel) (Max.)
Maximum voltage drop at ON	1.5V or less	
Surge protector	Zener diode RD47FM(NEC) or the equivalence for it	
Response time	200 μ sec within	

Table 6.1. Specification <2/2>

Item	Specification
Common	
I/O address	8 bits x 32 ports
Interruption level	1 level use
Max. board count for connection	16 boards including the master board
Dielectric strength	500Vrms
External circuit power supply	12 - 24VDC ($\pm 10\%$)
Power consumption	5VDC 200mA (Max.)
Operating condition	0 - 50°C, 10 - 90%RH(No condensation)
Allowable distance of signal extension	Approx. 50m (depending on wiring environment)
Bus specification	PCI (32bit, 33MHz, Universal key shapes supported *2)
Dimension (mm)	176.41(L) x 105.68(H)
Weight	215g

*1 Data "0" and "1" correspond to the Low and High levels, respectively.

*2 This board requires power supply at +5V from an expansion slot (it does not work on a machine with a +3.3V power supply alone).

Board Dimensions

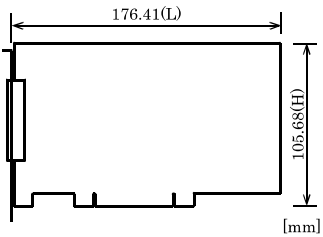

The standard outside dimension (L) is the distance from the end of the board to the outer surface of the slot cover.

Block Diagram

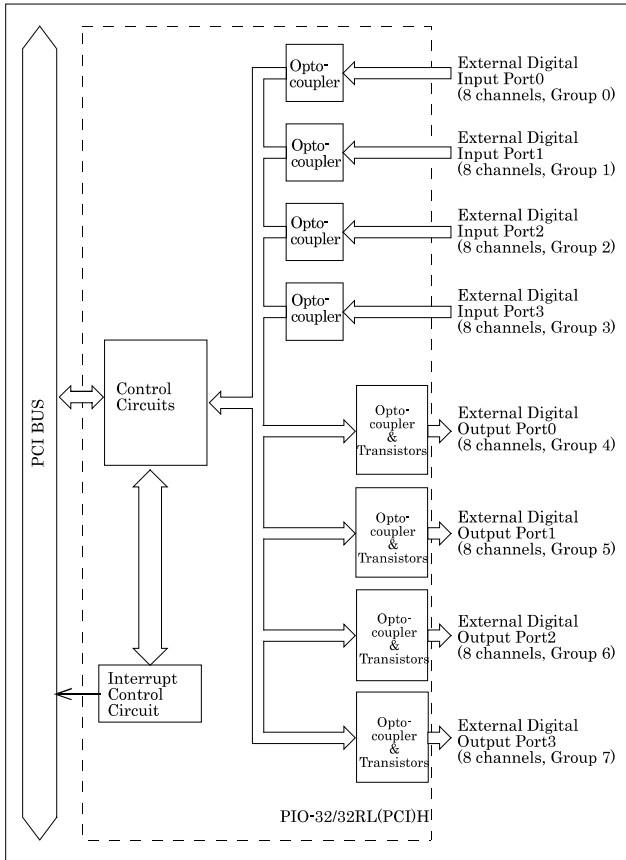

Figure 6.1. Block Diagram

PIO-32/32RL(PCI)H

User's Guide

CONTEC CO., LTD.

March 2016 Edition

3-9-31, Himesato, Nishiyodogawa-ku, Osaka 555-0025, Japan

Japanese <http://www.contec.co.jp/>

English <http://www.contec.com/>

Chinese <http://www.contec.com.cn/>

No part of this document may be copied or reproduced in any form by any means without prior written consent of CONTEC CO., LTD. [03302016]

[08052004]

Management No. A-46-893

[03302016_rev5]

Parts No. LYDW844