

PC-HELPER

Digital I/O Board with Opto-Isolation
for PCI

PIO-32/32B(PCI)V

User's Guide

CONTEC CO., LTD.

Check Your Package

Thank you for purchasing the CONTEC product.

The product consists of the items listed below.

Check, with the following list, that your package is complete. If you discover damaged or missing items, contact your retailer.

Product Configuration List

- PIO-32/32B(PCI)V ...1
- First step guide ...1
- Disk *1 [API-PAC(W32)] ...1
- Warranty Certificate ...1
- Serial Number Label ...1

*1 The bundled disk contains the driver software and User's Guide (this guide)

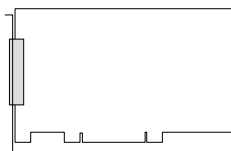

Board

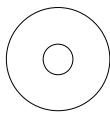

Disk
[API-PAC(W32)]



First step guide



Warranty Certificate



Serial Number Label

Copyright

Copyright 2005 CONTEC CO., LTD. ALL RIGHTS RESERVED

No part of this document may be copied or reproduced in any form by any means without prior written consent of CONTEC CO., LTD.

CONTEC CO., LTD. makes no commitment to update or keep current the information contained in this document. The information in this document is subject to change without notice.

All relevant issues have been considered in the preparation of this document. Should you notice an omission or any questionable item in this document, please feel free to notify CONTEC CO., LTD.

Regardless of the foregoing statement, CONTEC assumes no responsibility for any errors that may appear in this document nor for results obtained by the user as a result of using this product.

Trademarks

MS, Microsoft, Windows, Windows NT and MS-DOS are trademarks of Microsoft Corporation. Other brand and product names are trademarks of their respective holder.

Table of Contents

Check Your Package	i
Copyright	ii
Trademarks	ii
Table of Contents.....	iii

1. BEFORE USING THE PRODUCT	1
------------------------------------	----------

About the Board	1
Features.....	1
Support Software.....	3
Cable & Connector (Option).....	4
Accessories (Option).....	5
Customer Support	6
Web Site	6
Limited Three-Years Warranty	6
How to Obtain Service	6
Liability.....	6
Safety Precautions.....	7
Safety Information.....	7
Handling Precautions	8
Environment.....	9
Inspection	9
Storage	9
Disposal	9

2. SETUP	11
-----------------	-----------

What is Setup?.....	11
Using the Board under Windows Using the Driver Library API-PAC(W32)	11
Using the Board under an OS Other than Windows	11
Step 1 Installing the Software.....	12
About the driver to be used	12
Select API-DIO(WDM)	14
Step 2 Setting the Hardware	15
Parts of the Board and Factory Defaults	15
Setting the Board ID.....	16
Selecting Power Supply	17
Plugging the Board.....	18
Step 3 Installing the Hardware	19
Turning on the PC	19
Found New Hardware Wizard Setting	20

Step 4 Initializing the Software.....	21
Step 5 Operation Checks.....	23
Check Method.....	23
Setup Troubleshooting	26
Symptoms and Actions	26

3. EXTERNAL CONNECTION	27
-------------------------------	-----------

Using the On-board Connectors.....	27
Connecting a Device to a Connector.....	27
Connector Pin Assignment	28
Relationships between API-PAC(W32) Logical Ports/Bits and Connector Signal Pins.....	30
Connecting Input Signals.....	31
Input Circuit.....	31
Connecting a Switch	32
Connecting Output Signals.....	33
Output Circuit	33
Connection to the LED	34
Example of Connection to TTL Level Input	34
Connecting the Sink Type Output and Sink Output Support Input.....	35

4. FUNCTION	37
--------------------	-----------

Data I/O Function	37
Data Input.....	37
Data Output	37
Monitoring Output Data	37
Digital Filter Function.....	38
Digital Filter Function Principle.....	38
Set Digital Filter Time	38
Interrupt Control Function.....	39
Disabling/enabling Interrupts.....	39
Selecting the Edge of input signals, at which to generate an interrupt.....	39
Clearing the Interrupt Status and Interrupt Signal.....	39

5. ABOUT SOFTWARE	41
--------------------------	-----------

About Software for Windows.....	41
Accessing the Help File.....	41
Using Sample Programs	42
Uninstalling the Driver Libraries.....	43
About Software for Linux	44
Driver Software Install Procedure	44
Accessing the Help File.....	45
Using Sample Programs	45

Uninstalling the driver 45

6. ABOUT HARDWARE 47

Hardware specifications 47

Block Diagram 49

Differences between the PIO-32/32B(PCI)V and PIO-32/32B(PCI)H..... 50

1. Before Using the Product

This chapter provides information you should know before using the product.

About the Board

This board is a PCI bus-compliant interface board for input/output of digital signals.

It can be inputted by switch and relay.

PIO-32/32B(PCI)V can input and output up to 32 channels.

And this board is the equivalent of PIO-32/32B(PCI)H. For the detail, please refer to the chapter 6 Differences between PIO32/32B(PCI)H and PIO32/32B(PCI)V.

Using the bundled driver library package [API-PAC(W32)], you can create Windows application software for this board in your favorite programming language supporting Win32 API functions, such as Visual Basic or Visual C/C++.

Features

- Opto-coupler isolated input (compatible with current sink output) and opto-coupler isolated open-collector output (current sink type)

This product has the opto-coupler isolated input 32channels (compatible with current sink output) whose response speed is 200 μ sec and opto-coupler isolated open-collector output 32channels (current sink type). Common terminal provided per 16channels, capable of supporting a different external power supply. Supporting driver voltages of 12 - 24 VDC for I/O.

- Opto-coupler bus isolation

As the PC is isolated from the input and output interfaces by opto-couplers, this product has excellent noise performance.

- Power for opto-coupler operation (12VDC 240mA) supplied internally

As the power to run the opto-couplers is supplied internally, no external power supply is required. The use of jumpers allows you to decide whether you want to use the internal or external power supply for every 16 points.

- You can use all of the input signals as interrupt request signals.

You can use all of the input signals as interrupt request signals and also disable or enable the interrupt in bit units and select the edge of the input signals, at which to generate an interrupt.

- Windows/Linux compatible driver libraries are attached.

Using the attached driver library API-PAC(W32) makes it possible to create applications of Windows/Linux. In addition, a diagnostic program by which the operations of hardware can be checked is provided.

- This product has a digital filter to prevent wrong recognition of input signals from carrying noise or a chattering.

This product has a digital filter to prevent wrong recognition of input signals from carrying noise or a chattering. All input terminals can be added a digital filter, and the setting can be performed by software.

- The output circuit, has a built-in Zener diode and the overcurrent protection circuit of the surge voltage protection.

Zener diodes are connected to the output circuits to protect against surge voltages. In addition, the output circuit, it attaches the overcurrent protection circuit at the output 8-channel unit. The output rating is max. 35VDC, 100mA per channel.

- LabVIEW is supported by a plug-in of dedicated library.

Using the dedicated library makes it possible to make a LabVIEW application.

Support Software

You should use CONTEC support software according to your purpose and development environment.

Windows version of digital I/O driver **API-DIO(WDM)/API-DIO(98/PC)**

[Stored on the bundled disk driver library API-PAC(W32)]

The API-DIO(WDM) is the Windows version driver library software that provides products in the form of Win32 API functions (DLL). Various sample programs such as Visual Basic and Visual C++, etc and diagnostic program *1useful for checking operation is provided.

For more details on the supported OS, applicable language and new information, please visit the CONTEC's Web site.

Linux version of digital I/O driver **API-DIO(LNX)**

[Stored on the bundled disk driver library API-PAC(W32)]

The API-DIO(LNX) is the Linux version driver software which provides device drivers (modules) by shared library and kernel version. Various sample programs of gcc are provided.

For more details on the supported OS, applicable language and new information, please visit the CONTEC's Web site.

LabVIEW-support data acquisition library **DAQfast for LabVIEW**

(Available for downloading (free of charge) from the CONTEC web site.)

This is a data collection library to use in the LabVIEW by National Instruments. With Polymorphic VI, our design enables a LabVIEW user to operate seamlessly. Our aim is that the customers to perform easily, promptly what they wish to do.

For more details on the library and download of DAQfast for LabVIEW, please visit the CONTEC's Web site.

Data acquisition library for LabVIEW **VI-DAQ** (Available for downloading (free of charge) from the CONTEC web site.)

This is a VI library to use in National Instruments LabVIEW.

VI-DAQ is created with a function form similar to that of LabVIEW's Data Acquisition VI, allowing you to use various devices without complicated settings.

For more details on the library and download of VI-DAQ, please visit the CONTEC's Web site.

Cable & Connector (Option)

Shield Cable with 96-Pin Half-Pitch Connector at Both Ends (Mold Type)

- : PCB96PS-0.5P (0.5m)
- : PCB96PS-1.5P (1.5m)
- : PCB96PS-3P (3m)
- : PCB96PS-5P (5m)

Flat Cable with 96-Pin Half-Pitch Connectors at Both Ends

- : PCB96P-1.5 (1.5m)
- : PCB96P-3 (3m)

Shield Cable with 96-Pin Half-Pitch Connector at One End (Mold Type)

- : PCA96PS-0.5P (0.5m)
- : PCA96PS-1.5P (1.5m)
- : PCA96PS-3P (3m)
- : PCA96PS-5P (5m)

Flat Cable with 96-Pin Half-Pitch Connector at One End

- : PCA96P-1.5 (1.5m)
- : PCA96P-3 (3m)

Distribution Shield Cable with 96-Pin Half-Pitch Connector (96Pin→37Pin x 2)

- : PCB96WS-1.5P (1.5m)
- : PCB96WS-3P (3m)
- : PCB96WS-5P (5m)

Accessories (Option)

Screw Terminal	: EPD-96A *1
Screw Terminal	: EPD-96 *1
Digital I/O 64CH Series Terminal Panel	: DTP-64A *1
Signal Monitor for Digital I/O(64Bits)	: CM-64L *1
Screw Terminal	: EPD-37A *2
Screw Terminal	: EPD-37 *2
Signal Monitor for Digital I/O	: CM-32L *2
Connection Conversion Board (96-Pin → 37-Pin x 2)	: CCB-96 *3

*1 A PCB96P or PCB96PS optional cable is required separately.

*2 A PCB96W or PCB96WS optional cable is required separately.

*3 Option cable PCB96P or PCB96PS, and the cable for 37-pin D-SUB are required separately.

* Check the CONTEC's Web site for more information on these options.

Customer Support

CONTEC provides the following support services for you to use CONTEC products more efficiently and comfortably.

Web Site

<https://www.contec.com/>

Latest product information

CONTEC provides up-to-date information on products.

CONTEC also provides product manuals and various technical documents in the PDF.

Free download

You can download updated driver software and differential files as well as sample programs available in several languages.

Note! For product information

Contact your retailer if you have any technical question about a CONTEC product or need its price, delivery time, or estimate information.

Limited Three-Years Warranty

CONTEC Interface boards are warranted by CONTEC CO., LTD. to be free from defects in material and workmanship for up to three years from the date of purchase by the original purchaser.

Repair will be free of charge only when this device is returned freight prepaid with a copy of the original invoice and a Return Merchandise Authorization to the distributor or the CONTEC group office, from which it was purchased.

This warranty is not applicable for scratches or normal wear, but only for the electronic circuitry and original boards. The warranty is not applicable if the device has been tampered with or damaged through abuse, mistreatment, neglect, or unreasonable use, or if the original invoice is not included, in which case repairs will be considered beyond the warranty policy.

How to Obtain Service

For replacement or repair, return the device freight prepaid, with a copy of the original invoice. Please obtain a Return Merchandise Authorization Number (RMA) from the CONTEC group office where you purchased before returning any product.

* No product will be accepted by CONTEC group without the RMA number.

Liability

The obligation of the warrantor is solely to repair or replace the product. In no event will the warrantor be liable for any incidental or consequential damages due to such defect or consequences that arise from inexperienced usage, misuse, or malfunction of this device.

Safety Precautions

Understand the following definitions and precautions to use the product safely.

Safety Information

This document provides safety information using the following symbols to prevent accidents resulting in injury or death and the destruction of equipment and resources. Understand the meanings of these labels to operate the equipment safely.

⚠ DANGER	DANGER indicates an imminently hazardous situation which, if not avoided, will result in death or serious injury.
⚠ WARNING	WARNING indicates a potentially hazardous situation which, if not avoided, could result in death or serious injury.
⚠ CAUTION	CAUTION indicates a potentially hazardous situation which, if not avoided, may result in minor or moderate injury or in property damage.

Handling Precautions

DANGER

Do not use the product where it is exposed to flammable or corrosive gas. Doing so may result in an explosion, fire, electric shock, or failure.

CAUTION

- There are switches and jumpers on the board that need to be set in advance. Be sure to check these before installing the board.
 - Only set the switches and jumpers on the board to the specified settings. Otherwise, the board may malfunction, overheat, or cause a failure.
 - Do not strike or bend the board. Doing so could damage the board. Otherwise, the board may malfunction, overheat, cause a failure or breakage.
 - Do not touch the board's metal plated terminals (edge connector) with your hands. Otherwise, the board may malfunction, overheat, or cause a failure. If the terminals are touched by someone's hands, clean the terminals with industrial alcohol.
 - Do not install or remove the board to or from the slot while the computer's power is turned on. Otherwise, the board may malfunction, overheat, or cause a failure. Doing so could cause trouble. Be sure that the personal computer or the I/O expansion unit power is turned off.
 - Make sure that your PC or expansion unit can supply ample power to all the boards installed. Insufficiently energized boards could malfunction, overheat, or cause a failure.
 - The specifications of this product are subject to change without notice for enhancement and quality improvement. Even when using the product continuously, be sure to read the manual and understand the contents.
 - Do not modify the product. CONTEC will bear no responsibility for any problems, etc., resulting from modifying this product.
 - Regardless of the foregoing statements, CONTEC is not liable for any damages whatsoever (including damages for loss of business profits) arising out of the use or inability to use this CONTEC product or the information contained herein.
-

Environment

Use this product in the following environment. If used in an unauthorized environment, the board may overheat, malfunction, or cause a failure.

Operating temperature

0 - 50°C

Operating humidity

10 - 90%RH (No condensation)

Corrosive gases

None

Floating dust particles

Not to be excessive

Inspection

Inspect the product periodically as follows to use it safely.

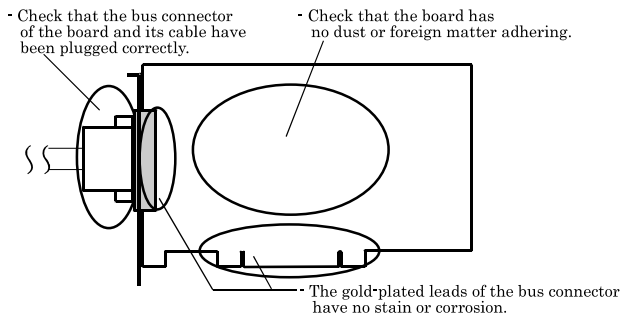

Storage

When storing this product, keep it in its original packing form.

- (1) Put the board in the storage bag.
- (2) Wrap it in the packing material, then put it in the box.
- (3) Store the package at room temperature at a place free from direct sunlight, moisture, shock, vibration, magnetism, and static electricity.

Disposal

When disposing of the product, follow the disposal procedures stipulated under the relevant laws and municipal ordinances.

2. Setup

This chapter explains how to set up the board.

What is Setup?

Setup means a series of steps to take before the product can be used.

Different steps are required for software and hardware.

The setup procedure varies with the OS and software used.

Using the Board under Windows

Using the Driver Library API-PAC(W32)

This section describes the setup procedure to be performed before you can start developing application programs for the board using the bundled disk “Driver Library API-PAC(W32)”.

Taking the following steps sets up the software and hardware. You can use the diagnosis program later to check whether the software and hardware function normally.

Step 1 Installing the Software

Step 2 Setting the Hardware

Step 3 Installing the Hardware

Step 4 Initializing the Software

Step 5 Operation Checks

If Setup fails to be performed normally, see the “Setup Troubleshooting” section at the end of this chapter.

Using the Board under an OS Other than Windows

For using the board under an OS other than Windows, see the following parts of this user’s guide.

This chapter Step 2 Setting the Hardware

Chapter 3 External Connection

Chapter 6 About Hardware

Step 1 Installing the Software

This section describes how to install the Driver libraries.

Before installing the hardware in a PC, install "Driver Library API-PAC(W32)" from the bundled media or download and install the latest edition of this software from the CONTEC web site.

Although some user interfaces are different depending on the OS used, the basic procedure is the same.

About the driver to be used

Two Digital I/O drivers are available : API-DIO(WDM) and API-DIO(98/PC).

When using this product, use the advanced digital I/O driver "API-DIO(WDM)". The following information is focused on setting up API-DIO(WDM).

If API-DIO(98/PC) using existing systems continue to use API-DIO(98/PC).

Please note that the API-DIO(98/PC) does not support Windows 8 or later, and the 64-bit OS.

Use the API-DIO(98/PC)

If you are installing from disk attachments, select "all" from the "Installer" later in this chapter and starts the execution environment and development environment packages installer

Please see the Help folder in the installed hardware installation instructions please see reference in help disk attachments or downloaded from CONTEC's Web site development environment.

Furthermore, that applies to the default step 4 software described below, see config.chm folder installed execution environment

Starting the Install Program

- (1) Load the bundled disk [API-PAC(W32)] on your PC.
- (2) The API-PAC(W32) Installer window appears automatically.
If the panel does not appear, run (drive letter):\AUTORUN.exe.
- (3) Click on the [Install Development or Execution Environment] button.

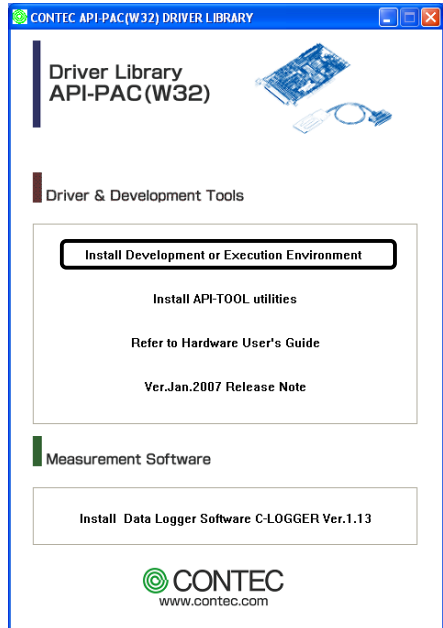

⚠ CAUTION

Before installing the software in Windows 2000 or later, log in as a user with administrator privileges.

Select API-DIO(WDM)

Selecting API-DIO(WDM)

- (1) The following dialog box appears to select “Driver to install” and “Install option”, “Usage of driver library”.
- (2) Select the "Advanced Digital I/O driver".
- (3) Click on the [Install] button.

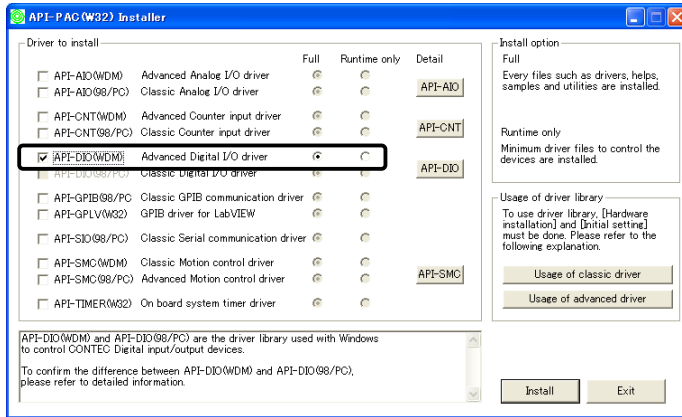

- * Clicking the [API-DIO] button under the “Detail” displays detailed information about API-DIO(WDM) and API-DIO(98/PC).

Run the installation

- (1) Complete the installation by following the instructions on the screen.
- (2) The Readme file appears when the installation is complete.

Step 2 Setting the Hardware

This section describes how to set the board and plug it on your PC.

The board has some switches and jumper to be preset.

Check the on-board switches and jumpers before plugging the board into an expansion slot.

The board can be set up even with the factory defaults untouched. You can change board settings later.

Parts of the Board and Factory Defaults

Figure 2.1. shows the names of major parts on the board.

Note that the switch setting shown below is the factory default.

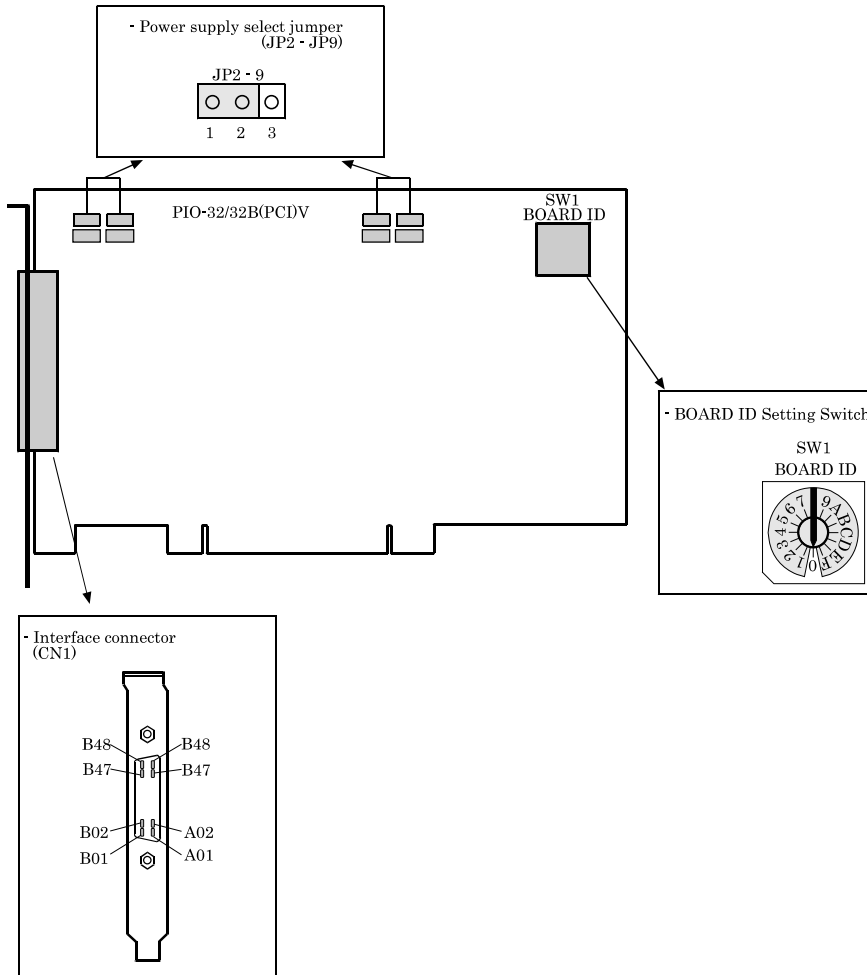

Figure 2.1. Component Locations

Setting the Board ID

If you install two or more boards on one personal computer, assign a different ID value to each of the boards to distinguish them.

The board IDs can be set from 0 - Fh to identify up to sixteen boards.

If only one board is used, the original factory setting (Board ID = 0) should be used.

Setting Procedure

To set the board ID, use the rotary switch on the board. Turn the SW1 knob to set the board ID as shown below.

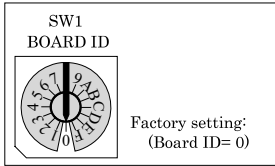

Figure 2.2. Board ID Settings (SW1)

Selecting Power Supply

















The photo-insulation circuits need power supply isolated from the PC system. This board equips an on board isolated power supply (12VDC, 250mA) for driving photo-insulation circuits. You can select to use this internal power supply or use an external power supply for driving the photo-insulation circuits in unit of two ports (16 channels) per common.

⚠ CAUTION

- When the internal power supply is used, the input section of this board consumes up to 80mA current maximum and the output channel switching section consumes up to 60mA current maximum. Note that the output current that can be supplied to the external device is therefore 110mA maximum in case you use internal power supply for all the input and output channels.
- The both internal and external supply must not be used simultaneously. Or the supply will be broken down.

Setting method

Jumpers JP2 - JP9 are used to select the power supply for photo-insulation circuits. Refer following table for details.

	Use Interna Power	Use External Power
+0 port (Input)	JP2 	JP2 
+1 port (Input)	JP3  1 2 3	JP3  1 2 3
+2 port (Input)	JP4 	JP4 
+3 port (Input)	JP5  1 2 3	JP5  1 2 3
+4 port (Output)	JP6 	JP6 
+5 port (Output)	JP7  1 2 3	JP7  1 2 3
+6 port (Output)	JP8 	JP8 
+7 port (Output)	JP9  1 2 3	JP9  1 2 3

* Factory setting

Notes : These jumpers must be set in pairs.

Figure 2.3. Power Supply Selecting

Plugging the Board

- (1) Before plugging the board, shut down the system, unplug the power cord of your PC.
- (2) Remove the cover from the PC so that the board can be mounted.
- (3) Plug the board into an expansion slot.
- (4) Attach the board bracket to the PC with a screw.
- (5) Put the cover back into place.



Applicable PCI bus slots

PCI bus slots used in PCs have keys to prevent 5V and 3.3V PCI bus boards from being accidentally plugged into wrong bus slots. This board can be plugged into both of the 5V and 3.3V PCI bus slots.

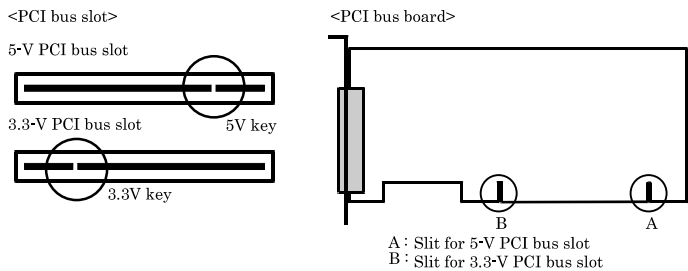

⚠ CAUTION

- Do not touch the board's metal plated terminals (edge connector) with your hands. Otherwise, the board may malfunction, overheat, or cause a failure. If the terminals are touched by someone's hands, clean the terminals with industrial alcohol.
- Do not install or remove the board to or from the slot while the computer's power is turned on. Otherwise, the board may malfunction, overheat, or cause a failure. Doing so could cause trouble. Be sure that the personal computer or the I/O expansion unit power is turned off.
- Make sure that your PC or expansion unit can supply ample power to all the boards installed. Insufficiently energized boards could malfunction, overheat, or cause a failure.
- Power supply from the PCI bus slot at +5V is required.

Step 3 Installing the Hardware

For using an expansion board under Windows, you have to let the OS detect the I/O addresses and interrupt level to be used by the board. The process is referred to as installing the hardware.

In the case of using two or more boards, make sure you install one by one with the Add New Hardware Wizard.

Turning on the PC

Turn on the power to your PC.

CAUTION

- The board cannot be properly installed unless the resources (I/O addresses and interrupt level) for the board can be allocated. Before attempting to install the board, first determine what PC resources are free to use.
 - The resources used by each board do not depend on the location of the PCI bus slot or the board itself. If you remove two or more boards that have already been installed and then remount one of them on the computer, it is unknown that which one of the sets of resources previously assigned to the two boards is assigned to the remounted board. In this case, you must check the resource settings.
-

Found New Hardware Wizard Setting

Depending on the OS that you use, the installation process may start automatically without starting the wizard. In this situation, proceed to "Step 4 Initializing the Software" section at the end of this chapter.

Performing installations on various operating systems

Help files containing the methods to follow in performing installations on different Windows operating systems are included on the bundled disk, so refer to the files in the following folder.

\\Help\Hwinst\Eng\ApiTool.chm

(1) The "Found New Hardware Wizard" will be started.



Select "No, not this time" and then click the "Next" button.

(2) When the model name of hardware is displayed, select "Install the software automatically [Recommended]" and then click on the "Next" button.

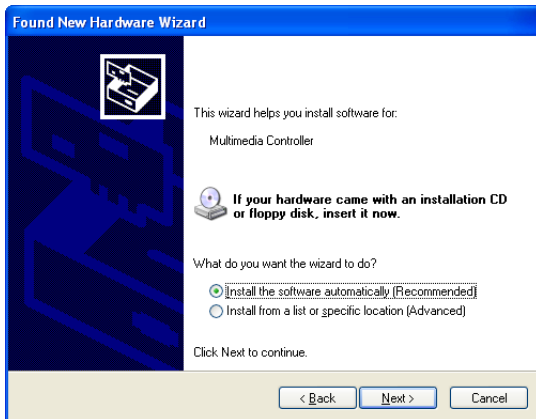

The device is automatically installed, and processing is completed.
You have now finished installing the initial setting of Hardware.

Step 4 Initializing the Software

The driver library requires the initial setting to recognize the execution environment. It is called the initialization of the Driver library.

This software is initialized automatically during hardware installation. Therefore, if you want to use it with its initial settings, you can skip the setting procedure described in Step 4. To change the device name, follow the setting procedure shown below.

Setting the device name

- (1) Run Device Manager. From [My Computer] - [Control Panel], select [System] and then select the [Device Manager] tab.
(You can also open Device Manager by right clicking on My Computer and selecting Properties.)

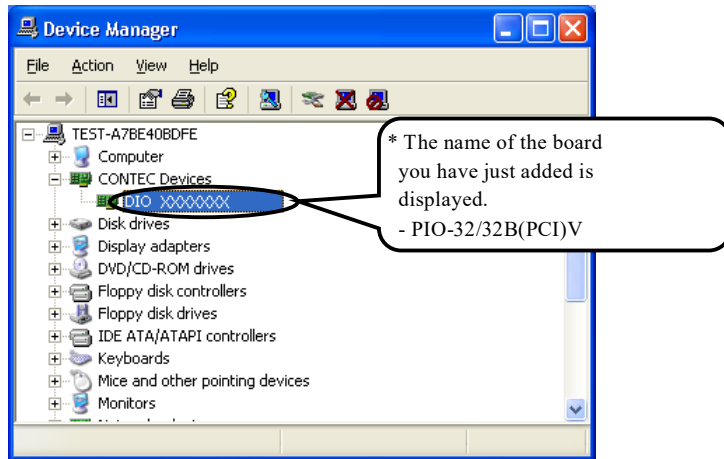

- (2) The installed hardware appears under the CONTEC Devices node. Open the CONTEC Devices node and select the device you want to setup (the device name should appear highlighted). Click [Properties].

- (3) The property page for the device opens.
Enter the device name in the common settings tab page and then click [OK].
The device name you set here is used later when programming.

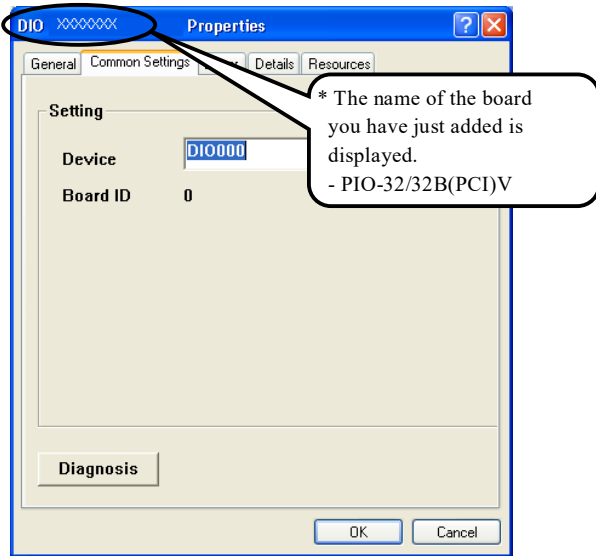

- * The initial device name that appears is a default value. You can use this default name if you wish.
- * Make sure that you do not use the same name for more than one device.

You have now finished installing the initial setting of Software.

Step 5 Operation Checks

You must make sure that the board and driver software operate normally. By taking this step, you can make sure that the board has been set up correctly.

Check Method

Connect the board to a remote device to test the input/output and check the execution environment.

Set the board in the default factory.

To connect an external device, see Chapter 3 “External Connection”.

Starting the Diagnosis Program

Open the “Properties” page of the device that was used for the software initialization, and press the [Diagnosis] button.

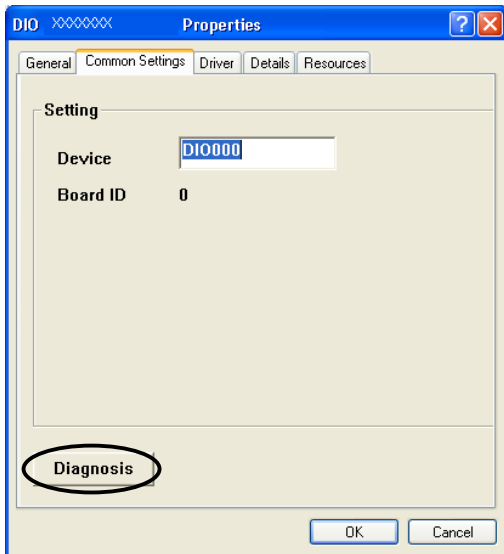

Checking Digital Inputs and Outputs

The main panel of the Diagnosis Program appears.

You can check the current operation states of the board in the following boxes:

- “Input Port” : Displays input values bit by bit at fixed time intervals.
- “Output Port” : Mouse operation allows the data to output or display.
- “Interrupt” : Displays the number of interrupts detected bit by bit.

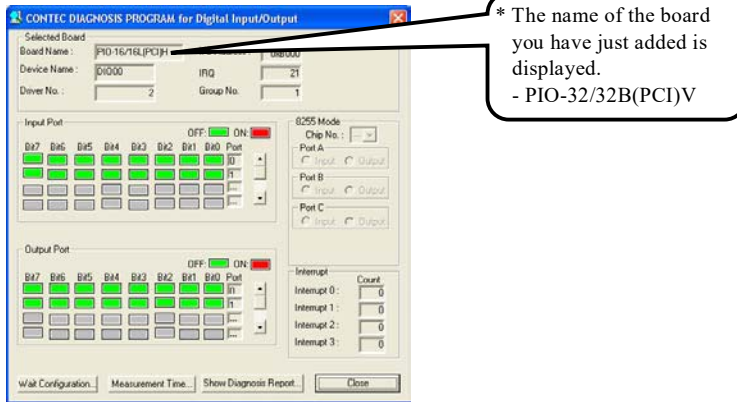

To use the function execution time measurement feature, click on the [Measurement Time] button.

Enter the I/O start port and the number of ports, then press the measurement button. The time for each execution of a function will be measured.

Diagnosis Report

- (1) Clicking on the [Show Diagnosis Report] button displays detailed data such as board settings and the diagnosis results while saving them in text format.
The Diagnosis Program performs “board presence/absence check”, “driver file test”, “board setting test”, and so on.

⚠ CAUTION

Before executing diagnosis report output, unplug the cable from the board.

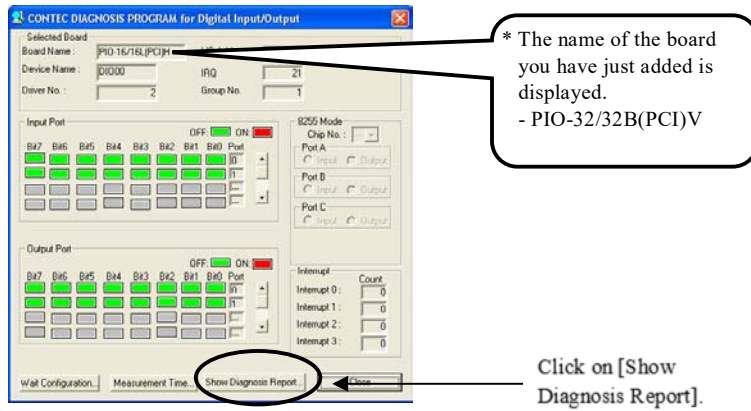

- (2) A diagnosis report is displayed as shown below.

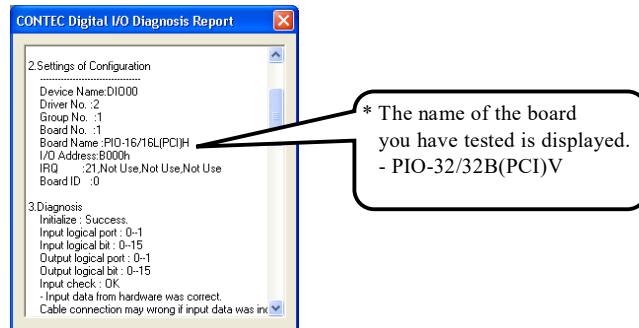

Setup Troubleshooting

Symptoms and Actions

The board works with the Diagnosis Program but not with an application.

The Diagnosis Program has been created using the driver API functions. If the board works with the Diagnosis Program, it will work with other applications. Review the program, paying attention to the following points.

- Check the return values of functions.
- Refer to the source code of sample program.

Refer to the “Troubleshooting” in API-TOOL(WDM) HELP (APITOOOL.chm)

3. External Connection

This chapter describes the interface connectors on the board and the external I/O circuits.

Check the information available here when connecting an external device.

Using the On-board Connectors

Connecting a Device to a Connector

To connect an external device to this board, plug the cable from the device into the interface connector (CN1).

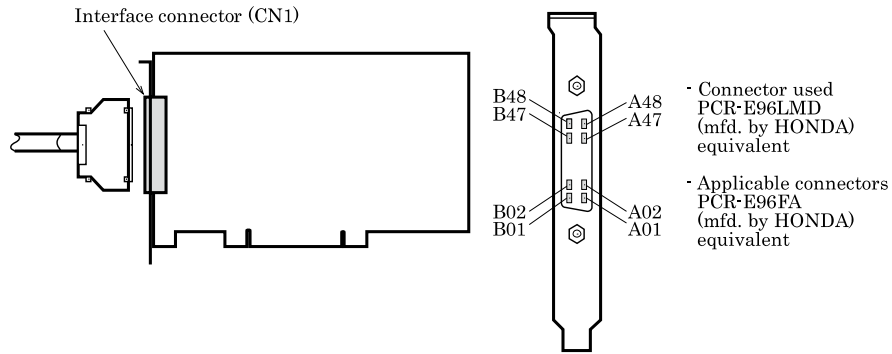
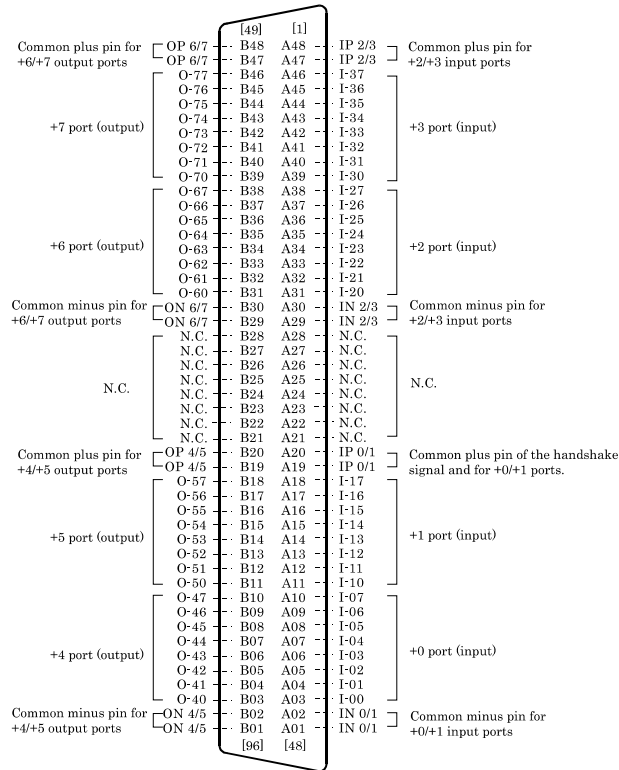

Figure 3.1. Connecting the Interface Connector

Connector Pin Assignment

Pin Assignments of Interface Connector <PIO-32/32B(PCI)V>



I-00 - I-37	32 input signal pins. Connect output signals from the external device to these pins.
O-40 - O-77	32 output signal pins. Connect these pins to the input signal pins of the external device.
IP 0/1, IP 2/3	When the external power supply is selected, its positive side is connected to these pins. When the internal power supply is used, these pins output power at +12 V. These pins are common to 16 input signal pins.
IN 0/1, IN 2/3	When the external power supply is selected, its negative side is connected to this pin. When the internal power supply is selected, this pin serves as the ground. These pins are common to 16 input signal pins.
OP 4/5, OP 6/7	When the external power supply is selected, its positive side is connected to these pins. When the internal power supply is used, these pins output power at +12 V. These pins are common to 16 input signal pins.
ON 4/5, ON 6/7	When the external power supply is selected, its negative side is connected to this pin. When the internal power supply is selected, this pin serves as the ground. These pins are common to 16 input signal pins.
N.C.	This pin is left unconnected.

Figure 3.2. Pin Assignments of Interface Connector < PIO-32/32B(PCI)V >

Pin Assignments of Optional Connector PCB96WS and CCB-96

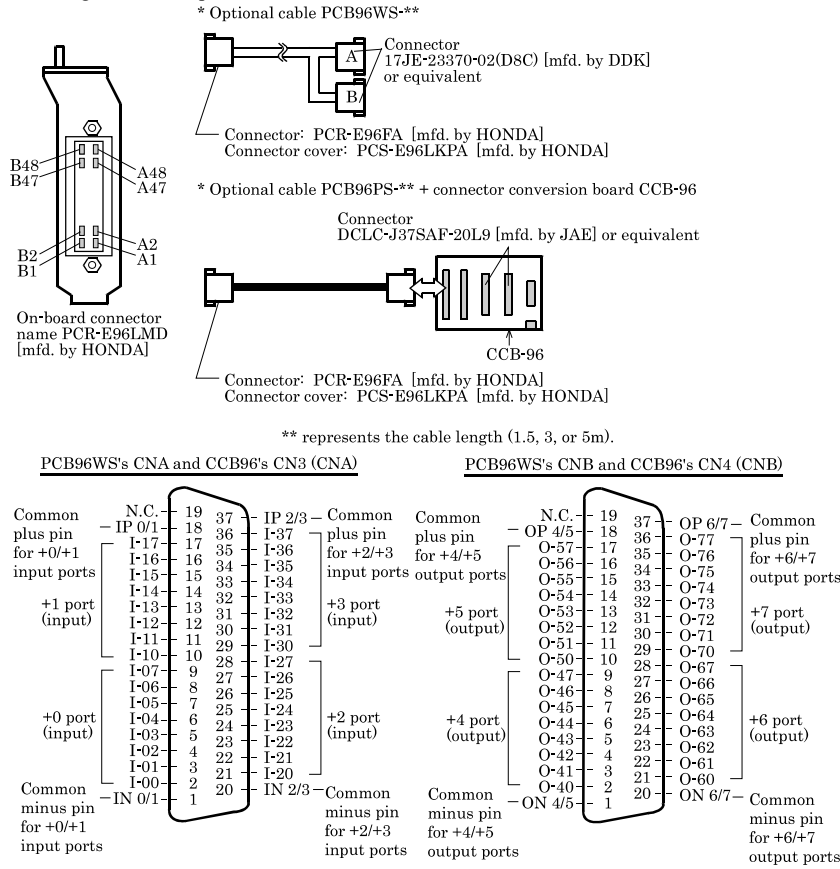

Figure 3.3. PCB96WS and CCB-96 Signal Assignments

Relationships between API-PAC(W32) Logical Ports/Bits and Connector Signal Pins

The following table lists the relationships between the connector signal pins and the logical port/bit numbers used for I/O functions when applications are written with API-PAC(W32).

PIO-32/32B(PCI)V

Table 3.1. Logical Ports, Logical Bits, and Connector Signal Pins <PIO-32/32B(PCI)V>

	D7	D6	D5	D4	D3	D2	D1	D0
Input logical port 0	I-07 [7]	I-06 [6]	I-05 [5]	I-04 [4]	I-03 [3]	I-02 [2]	I-01 [1]	I-00 [0]
Input logical port 1	I-17 [15]	I-16 [14]	I-15 [13]	I-14 [12]	I-13 [11]	I-12 [10]	I-11 [9]	I-10 [8]
Input logical port 2	I-27 [23]	I-26 [22]	I-25 [21]	I-24 [20]	I-23 [19]	I-22 [18]	I-21 [17]	I-20 [16]
Input logical port 3	I-37 [31]	I-36 [30]	I-35 [29]	I-34 [28]	I-33 [27]	I-32 [26]	I-31 [25]	I-30 [24]
	D7	D6	D5	D4	D3	D2	D1	D0
Output logical port0	O-47 [7]	O-46 [6]	O-45 [5]	O-44 [4]	O-43 [3]	O-42 [2]	O-41 [1]	O-40 [0]
Output logical port1	O-57 [15]	O-56 [14]	O-55 [13]	O-54 [12]	O-53 [11]	O-52 [10]	O-51 [9]	O-50 [8]
Output logical port2	O-67 [23]	O-66 [22]	O-65 [21]	O-64 [20]	O-63 [19]	O-62 [18]	O-61 [17]	O-60 [16]
Output logical port3	O-77 [31]	O-76 [30]	O-75 [29]	O-74 [28]	O-73 [27]	O-72 [26]	O-71 [25]	O-70 [24]

Note : I-xx represents a CAN input signal; O-xx represents a CNB output signal.
[xx] represents a logical bit.

⚠ CAUTION

The logical port and logical bit numbers are virtual port and bit numbers that enable programming independent of board I/O addresses or board types.

For details, refer to HELP after installing API-PAC(W32).

Connecting Input Signals

Connect the input signals to a device which can be current-driven, such as a switch or transistor output device.

The connection requires an external power supply to feed currents.

The board inputs the ON/OFF state of the current-driven device as a digital value.

Input Circuit

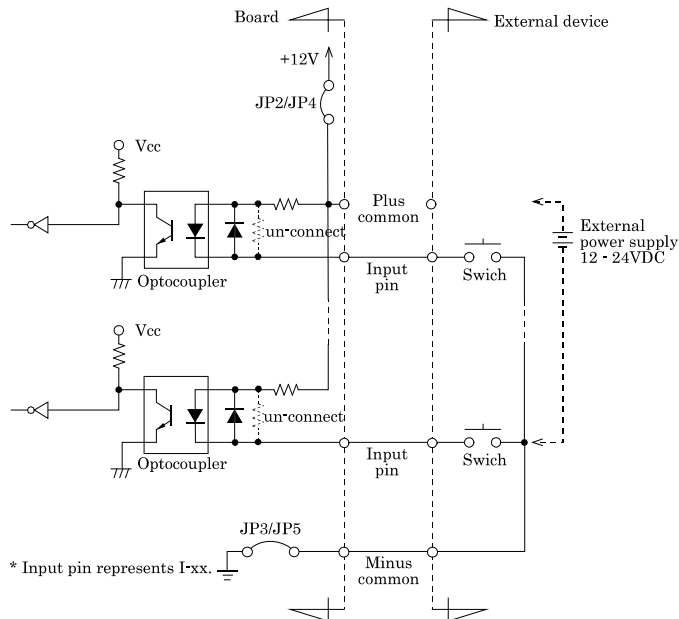

Figure 3.4. Input Circuit < PIO-32/32B(PCI)V >

The input circuits of interface blocks of the PIO-32/32B(PCI)V are illustrated in Figure 3.4. The signal inputs are isolated by opto-couplers (ready to accept current sinking output signals). The board therefore requires an additional power supply isolated from the PC system to drive the photo-isolated circuits. The board offers you an on-board isolated 12VDC power supply in option. In this case (using external supply), 5.1mA current is requested each channel on 24VDC (2.6mA on 12VDC).

⚠ CAUTION

Please refer to Selecting Power Supply, and choose the proper supply by jumps.

Connecting a Switch

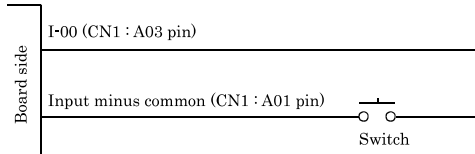

When the switch is ON, the corresponding bit contains 1.
When the switch is OFF, by contrast, the bit contains 0.

Figure 3.5. An Example to use Input I00 < PIO-32/32B(PCI)V >

Connecting Output Signals

Connect the output signals to a current-driven controlled device such as a relay or LED.

The connection requires an external power supply to feed currents.

The board controls turning on/off the current-driven controlled device using a digital value.

Output Circuit

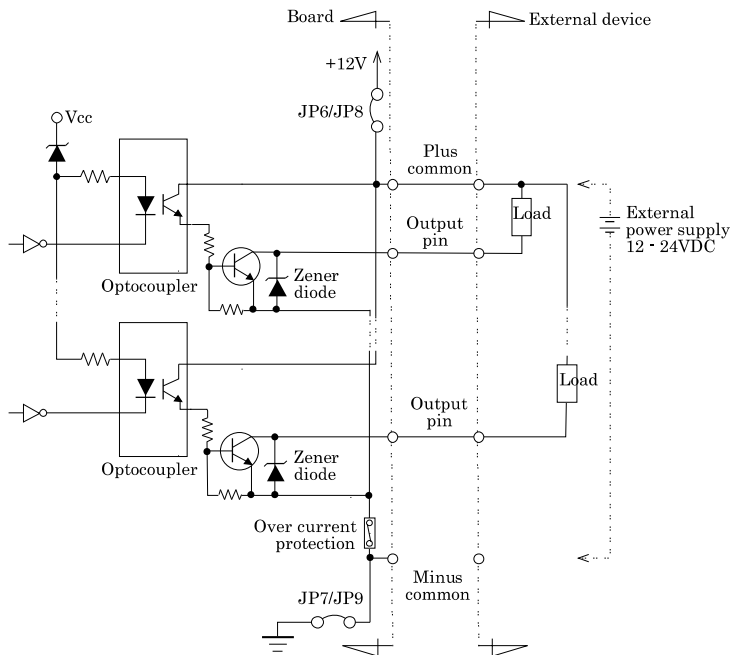

* Output pin represent output signals.

Figure 3.6. Output Circuit <PIO-32/32B(PCI)V>

The output circuits of interface blocks of the PIO-32/32B(PCI)V are illustrated in Figure 3.6. The signal output section is an opto-coupler isolated, open-collector output (current sink type). Driving the output section requires an additional power supply isolated from the PC system. The board offers you an on-board isolated 12VDC power supply in option.

The rated output current per channel is 100 mA at maximum.

The output section can also be connected to a TTL level input as it uses a low-saturated transistor for output. The residual voltage (low-level voltage) between the collector and emitter with the output on is 0.5 V or less at an output current within 50 mA or at most 1.0 V at an output current within 100 mA.

A zener diode is connected to the output transistor for protection from surge voltages. To protect against surge voltage, a Zener diode is connected to the output transistor. Also, an overcurrent protection circuit is attached to a unit of eight output channels.

⚠ CAUTION

When the PC is turned on, all output are reset to OFF.

Connection to the LED

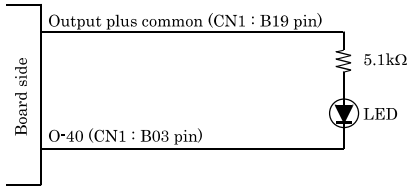

When "1" is output to a relevant bit, the corresponding LED comes on.
 When "0" is output to the bit, in contrast, the LED goes out.

Figure 3.7. An Example to use Output O-40 < PIO-32/32B(PCI)V >

Example of Connection to TTL Level Input

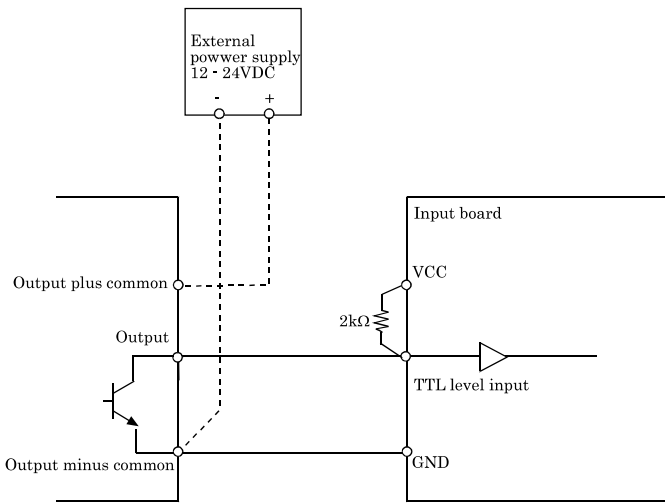

Figure 3.8. Connection Example of Output and TTL level Input Signal < PIO-32/32B(PCI)V >

Connecting the Sink Type Output and Sink Output Support Input

The following example shows a connection between a sink type output (output board) and a sink output support input (input board). Refer to this connection example when you connect such boards to each other.

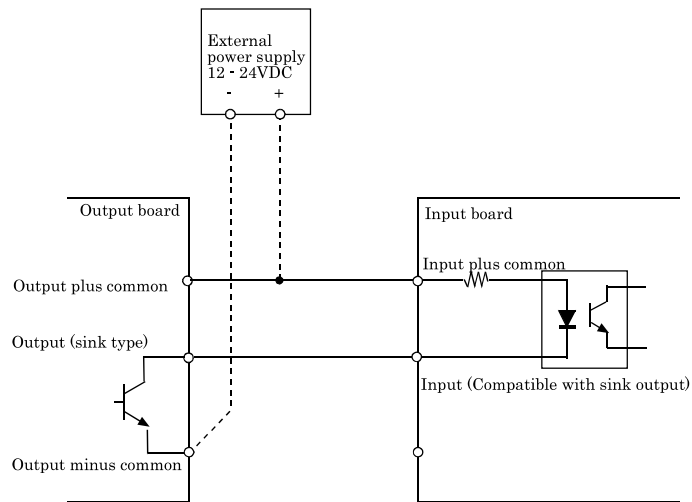

Figure 3.9. Example of Connecting the Sink Type Output and Sink Output Support Input

4. Function

This section describes the features of the board.

Each function described here can be easily set and executed by using the bundled API function library. For details, refer to HELP after installing API-PAC(W32).

Data I/O Function

Data Input

When input data is “ON”, “1” is input to the relevant bit.

When the input data is “OFF”, in contrast, “0” is input to the relevant bit

Data Output

When “1” is output to the relevant bit, the corresponding transistor is set to “ON”.

When “0” is output to the relevant bit, in contrast, the corresponding transistor is set to “OFF”.

CAUTION

When the PC is turned on, all output are reset to 0 (OFF).

Monitoring Output Data

The <PIO-32/32B(PCI)V> can read the state of the data currently being output without affecting the output data.

Digital Filter Function

Using this feature, the DIO-32/32B(PCI)V can apply a digital filter to every input pin, thereby preventing wrong recognition of input signals from being affected by noise or chattering.

Digital Filter Function Principle

The digital filter checks the input signal level during the sampling time of the clock signal. When the signal level remains the same for the digital filter set time, the digital filter recognizes that signal as the input signal and changes the signal level of the PC.

If the signal level changes at a frequency shorter than the set time, therefore, the level change is ignored.

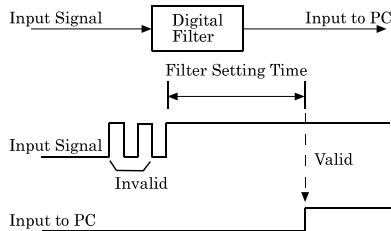

Figure 4.1. Digital Filter Function Principle

Set Digital Filter Time

Set the digital filter time to 0 - 20 (14h).

Setting the digital filter time to 0 disables digital filtering. It is set to 0 when the power is turned on.

Figure 4.2 shows the relationships between the digital filter time and the setting data.

$$\text{Digital Filter Time[sec.]} = 2^n / (8 \times 10^6)$$

$$n: = \text{setting data}(0 - 20)$$

Setting Data (n)	Digital Filter Time	Setting Data (n)	Digital Filter Time	Setting Data (n)	Digital Filter Time
0 (00h)	The filter function is not used.	7 (07h)	16μsec	14 (0Eh)	2.048msec
1 (01h)	0.25μsec	8 (08h)	32μsec	15 (0Fh)	4.096msec
2 (02h)	0.5μsec	9 (09h)	64μsec	16 (10h)	8.192msec
3 (03h)	1μsec	10 (0Ah)	128μsec	17 (11h)	16.384msec
4 (04h)	2μsec	11 (0Bh)	256μsec	18 (12h)	32.768msec
5 (05h)	4μsec	12 (0Ch)	512μsec	19 (13h)	65.536msec
6 (06h)	8μsec	13 (0Dh)	1.024msec	20 (14h)	131.072msec

Figure 4.2. Digital Filter Time and Setting Data

⚠ CAUTION

- If you set the digital filter time, the filter applies to all input pins. You cannot apply the filter only to a specific input pin.
- Do not set a value outside the above range to the Setting Data as doing so can cause the board to malfunction.

Interrupt Control Function

The PIO-32/32B(PCI)V can use all of the input signals as interrupt request signals.

The board can generate an interrupt request signal to the PC when the input signal change from High to Low or from Low to High.

When the digital filter (described above) is used, interrupt requests are generated by input signals that have passed through the filter.

Disabling/enabling Interrupts

Interrupt mask bits can be used to disable or enable the individual bits for interruptions.

Once a certain bit has been interrupt-disabled, no interrupt occurs even when the corresponding input signal changes its level.

To let interrupts occur, enable the corresponding interrupt mask bit for interruptions.

CAUTION

All of the interrupt mask bits are interrupt-disabled when the power is turned on.

Selecting the Edge of input signals, at which to generate an interrupt

The input signal edge selection bit can be used to set the input logic for interruption bit by bit.

If you set an input signal edge selection bit to 0, an interrupt occurs when the input value to the corresponding bit changes from 0 to 1 (at the fall of the input signal from High to Low).

If you set an input signal edge selection bit to 1, an interrupt occurs when the input value to the corresponding bit changes from 1 to 0 (at the rise of the input signal from Low to High).

CAUTION

All of the input signal edge selection bits are set to 0 when the power is turned on.

Clearing the Interrupt Status and Interrupt Signal

Interrupt status bits are used to identify the input signal bit being used for requesting an interrupt.

When an interrupt status is input, the interrupt request signal and the interrupt status are cleared automatically.

CAUTION

- All of the interrupt status bits are set to 0 when the power is turned on.
- If an interrupt mask bit has been set to disable interrupts, the interrupt status bit is not set even when the input signal changes its level.

5. About Software

About Software for Windows

The digital input / output for the driver, provides functions to perform the following functions :

- Digital input/output of specified ports
- Hardware digital input/output of specified bits
- Hardware digital filtering that prevents wrong recognition of input signals from being affected by noise or chattering.

For details, refer to the help file.

Accessing the Help File

The method to use in accessing the help file varies slightly depending on the version of the driver (the development environment) that is installed.

From the Start menu, click "CONTEC API-PAC(W32)" - "API-TOOL(WDM) HELP".

When this link does not exist,

From the Start menu, click "CONTEC API-PAC(W32)" - "API-DIO(WDM)" - "API-DIO(WDM) HELP".

* For the API-DIO(98/PC) driver,

From the Start menu, click "CONTEC API-PAC(W32)" - "API-DIO(98/PC)" - "API-DIO HELP".

Using Sample Programs

Sample programs have been prepared for specific basic applications.

For the API-DIO(WDM), The sample programs are stored in

\Program Files\CONTEC\API-PAC(W32)\DIOWDM\Sample

Use these sample programs as references for program development and operation check.

* When the installation folder is changed, the folder of the sample program is different.

Running a Sample Program

- (1) Click on the [Start] button on the Windows taskbar.
- (2) For the API-DIO(WDM), from the Start Menu, select “Programs” – “CONTEC API-PAC(W32)” – “API-DIO(WDM)” – “SAMPLE...”.
- (3) A sample program is invoked.

Sample Programs - Examples

- Sample program 1 : Inputs digital data through a specified port.
- Sample program 2 : Outputs digital data through a specified port.
- Sample program 3 : Inputs/outputs digital data from/to a programmable board.
- Sample program 4 : Inputs digital data from a specified port in the background.
- Sample program 5 : Inputs/outputs digital data from/to a specified bit.
- Sample program 6 : Services interrupts of a specified board.
- Sample program 7 : Provides process control of a specified board.
- Sample program 8 : Performs trigger monitoring of a specified board.
- Sample program 9 : Inputs digital data through a specified port using BCD data.
- Sample program 10 : Executes digital input (simple functions) at specified bits through a specified port.
- Sample program 11 : Services interrupts of a specified board (using an extended function).
- Sample program (Console): Inputs/outputs digital data through a specified port.

Uninstalling the Driver Libraries

< Uninstalling the device driver >

Run Device Manager. From [My Computer] - [Control Panel], select [System] and then select the [Device Manager] tab.

(You can also open Device Manager by right clicking on My Computer and selecting Properties.)

Select [Windows Driver Package - CONTEC (***)], and then click [Change/Remove].

* "***" contains the driver category name (caio, ccnt, cdio, csmc, etc.).

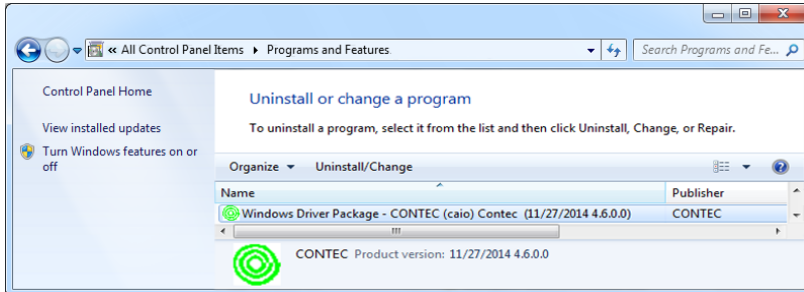

< Uninstall the development environment >

Use [My Computer] - [Control Panel] - [Programs and Features] to uninstall the development environment.

In case of API-***(WDM), select [CONTEC API-***(WDM) VerX.XX (Develop)] and then click [Uninstall].

* "***" contains the driver category name (AIO, CNT, DIO, SMC, etc.).

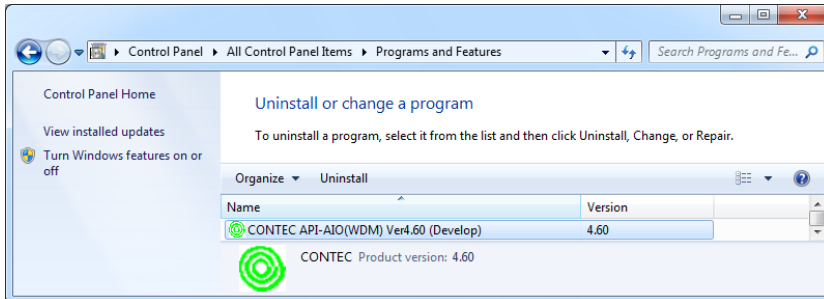

About Software for Linux

The Linux version of digital I/O function driver, API-DIO(LNX), provides functions that execute the following features:

- Digital input/output of specified ports
- Digital input/output of specified bits
- Hardware digital filtering that prevents chattering

For details, refer to the help file. The help file provides various items of information such as “Function Reference”, “Sample Programs”, and “FAQs”. Use them for program development and troubleshooting.

Driver Software Install Procedure

The Linux version for digital I/O driver, API-DIO(LNX), is supplied as a compressed file /linux/dio/cdioXXX.tgz on the bundled disk. (Note: XXX represents the driver version.)

Mount the bundled disk as shown below, copy the file to an arbitrary directory, and decompress the file to install the driver.

For details on using the driver, refer to readme.txt and the help file in HTML format extracted by installation.

To install the driver, log in as a superuser.

Decompression and setup procedure

```
# cd
# mount /dev/cdrom /mnt/cdrom           Mount the bundled disk.
# cp /mnt/cdrom/linux/dio/cdioXXX.tgz ./ Copy the compressed file.
# tar xvfz cdioXXX.tgz                 Decompress the compressed file.
.....
# cd contec/cdio
# make
                                     Compile the file.
.....
# make install                         Install.
.....
# cd config
# ./config                             Set up the board to be used.
..... Set as follows.....
# ./contec_dio_start.sh                Start the driver.
# cd
```

Accessing the Help File

- (1) Invoke a web browser in your X-Window environment.
- (2) In the browser, open diohelp.htm in the contec/cdio/help directory.

Using Sample Programs

Sample programs have been prepared for specific basic applications.

Sample programs for each language are contained in the contec/cdio/samples directory. For compiling them, refer to the manual for the desired language.

Uninstalling the driver

To uninstall the driver, use the uninstall shell script contained in the contec/cdio directory. For details, check the contents of the script.

6. About Hardware

This chapter provides hardware specifications and hardware-related supplementary information.

Hardware specifications

Table 6.1. Specifications < PIO-32/32B(PCI)V > < 1 / 2 >

Item	Specifications	
Input		
Input format	Opto-isolated input (Compatible with current sink output)(Negative logic *1)	
Number of input signal channels	32 channels (all available for interrupts) (One common power supply per 16 channels)	
Input resistance	4.7kΩ	
Input ON current	2.0mA or more	
Input OFF current	0.16mA or less	
Interrupt	32 interrupt input signals are arranged into a single output of interrupt signal INTA. An interrupt is generated at the rising edge (HIGH-to-LOW transition) or falling edge (LOW-to-HIGH transition).	
Response time	200μsec within	
Output		
Output format	Opto-isolated open collector output (current sink type) (Negative logic*1)	
Number of output signal channels	32 channels (One common power supply per 16 channels)	
Output rating	Output voltage	35VDC (Max.)
	Output current	100mA (par channel) (Max.)
Residual voltage with output on	0.5V or less (Output current≤50mA), 1.0V or less (Output current≤100mA)	
Surge protector	Zener diode RD47FM(NEC) or equivalent	
Response time	200μsec within	
Common		
I/O address	Any 32-byte boundary	
Interruption level	1 level use	
Max. board count for connection	16 boards	
Dielectric strength	500Vrms	
External circuit power supply	12 - 24VDC(±10%)	
Internal power	12VDC 250mA *2	

Table 6.1. Specifications < PIO-32/32B(PCI)V> <2/2>

Item	Specifications
Common	
Power consumption	5VDC 300mA(Max.) (Using the external power) 5VDC 1050mA(Max.)(Using the internal power)
Operating condition	0 - 50°C, 10 - 90%RH(No condensation)
Allowable distance of signal extension	Approx. 50m (depending on wiring environment)
PCI bus specification	32bit, 33MHz, Universal key shapes supported *3
Dimension (mm)	176.41(L) x 106.68(H) *4
Weight	215g
Standard	VCCI Class A, CE Marking (EMC Directive Class A, RoHS Directive)

*1 Data "0" and "1" correspond to the High and Low levels, respectively.

*2 When the internal power supply is used, the input section consumes a maximum of 80 mA and the output channel switching section consumes a maximum of 60 mA. In this case, therefore, the output current to be supplied from the board is 110 mA.

*3 This board requires +5V power supply from expansion slots (it does not operate in the environment of only +3.3V power supply).

*4 The size of board No.7283, No.7283A, and No.7283B is 176.41 (L) x 105.68 (H) mm.

Board Dimensions

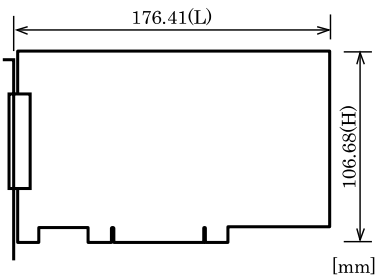

The standard outside dimension (L) is the distance from the end of the board to the outer surface of the slot cover.

Block Diagram

PIO-32/32B(PCI)V

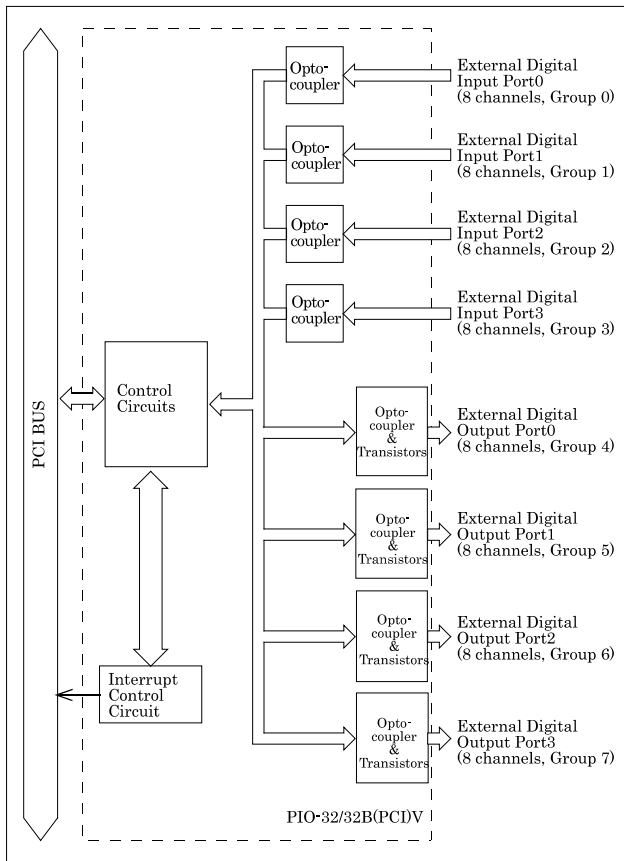

Figure 6.1. Block Diagram < PIO-32/32B(PCI)V >

Differences between the PIO-32/32B(PCI)V and PIO-32/32B(PCI)H

The PIO-32/32B(PCI)V is connector-pin compatible with the conventional PIO-32/32B(PCI)H but has the following differences from it:

- (1) Different in the number of input signals available to interrupt requests
PIO-32/32B(PCI)V : All of 32 channels
PIO-32/32B(PCI)H : 4 channels
- (2) Different in the expression to calculate the digital filter time (n: setting value)
PIO-32/32B(PCI)V : $2^n / (8 \times 10^6)$
PIO-32/32B(PCI)H : $2^n / (16 \times 10^6)$
- (3) Protective elements provided for outputs
PIO-32/32B(PCI)V : Surge protector: Zener diode
PIO-32/32B(PCI)H : Nothing
- (4) Different in interrupt level resource allocation
PIO-32/32B(PCI)V : Automatically allocates on interrupt level.
PIO-32/32B(PCI)H : Uses a jumper switch to select whether to allocate interrupt levels.
- (5) Different in whether ASIC or not
PIO-32/32B(PCI)V : Nothing
PIO-32/32B(PCI)H : ASIC
- (6) Different in Power Consumption
PIO-32/32B(PCI)V : 5VDC 300mA(Max.) (Using the external power)
5VDC 1050mA(Max.) (Using the internal power)
PIO-32/32B(PCI)H : 5VDC 300mA(Max.) (Using the external power)
5VDC 1300mA(Max.) (Using the internal power)

PIO-32/32B(PCI)V

User's Guide

CONTEC CO., LTD.

January 2018 Edition

3-9-31, Himesato, Nishiyodogawa-ku, Osaka 555-0025, Japan
<https://www.contec.com/>

No part of this document may be copied or reproduced in any form by any means without prior written consent of CONTEC CO., LTD. [01262018]

[03242005]

Management No. A-46-969

[01262018_rev2]

Parts No. LYEN362