

M-508 Quick Installation Guide

Overview

M-508 is a Linux ready Single Board Computer featuring four serial ports, 10/100 Mbps Ethernet, USB port and SD socket for flash disk expansion. The pre-install Linux OS and GNU tool chain make M-508 ready for your application development.

Features

1. ARM920T ARM Thumb Processor with 200MIPS at 180MHz, Memory Management Unit
2. 16-KByte Data Cache and 16-KByte Instruction Cache
3. 64MB SDRAM, 32MB Flash on board
4. 512KB non-volatile FRAM (M-508T only)
5. One 10/100 Mbps Ethernet
6. Two USB 2.0 full speed (12 Mbps) Host Ports
7. Multimedia Card Interface for SD memory card
8. Four RS-232/485 ports software selectable
9. Port 4 also supports RS-422
10. 32 General Purpose DIO
11. +5VDC power input
12. Pre-installed Standard Linux 2.6.14 OS
13. GNU tool chain available in Artila CD

Packing List

M-508 is shipped with following items

1. M-508
2. CB-F10M9-20 10-pin header to DB9 male cable x4
3. Artila CD includes Tool Chain, Installation guide and example programs



Optional Accessory

1. CB-F9F9-150: DB9 Female serial console Cable

M-508 Layout

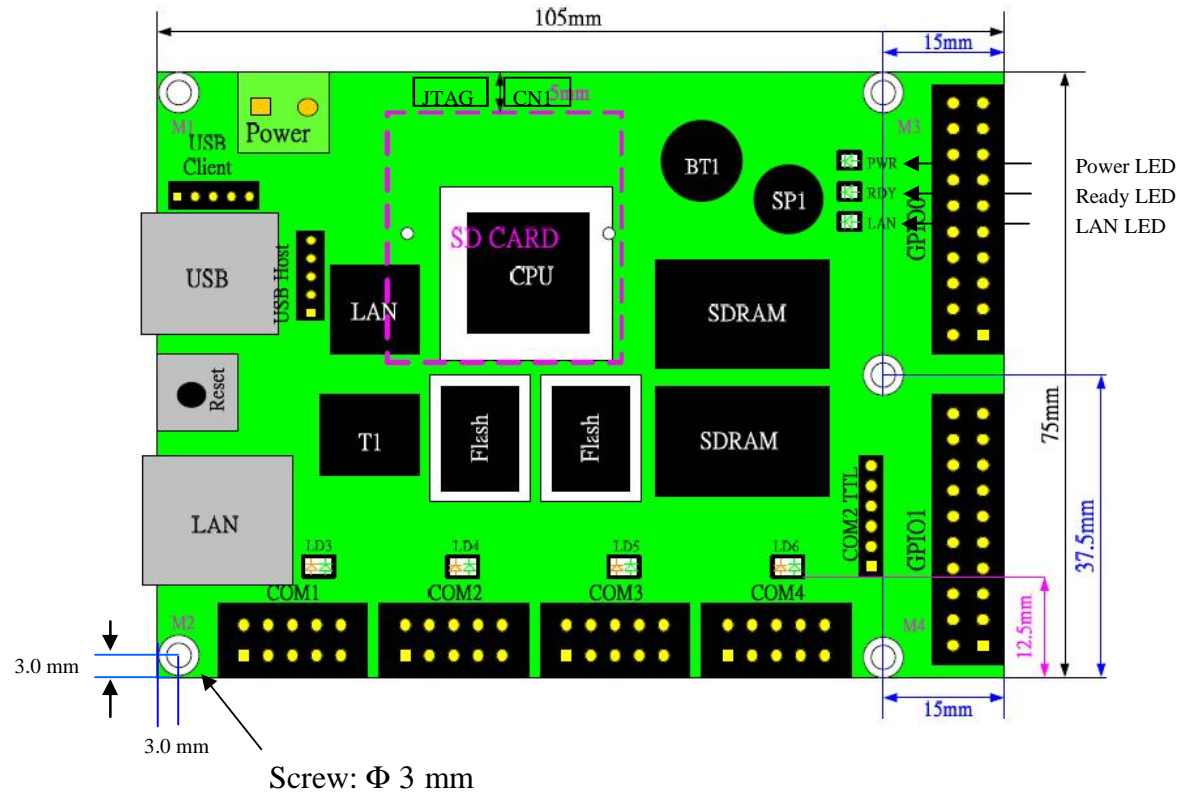

Power LED (PWR)

Power LED will keep solid green when power is applied.

Ready LED (RDY)

After Power ON, M-508 will decompress the kernel and root file system to RAMDISK. Once system is boot up, the Ready LED will show solid green. The Ready LED will be turned off after M-508 received “halt” command.

Link/Act (LAN)

When Ethernet port are connected to the network, Link/Act will show solid green and if there is traffic in the Ethernet, this LED will flash

Serial Port LED (LD3~LD6)

These four dual color LEDs indicate the data traffic at the serial ports. When RXD line is high then Orange light is ON and when TXD line is high, Green light is ON.

Debug LED (LD1~2)

The debug LEDs are located near LAN LED and are used for system boot debug. If system are correctly boot, they are switch off.

Serial Ports (COM1/COM2/COM3/COM4)

PIN	RS-232	RS-485	RS-422 **
1	DCD *	---	Tx-
2	DSR *	---	---
3	Rx	---	Tx+
4	RTS	---	---
5	Tx	Data+	Rx+
6	CTS	---	---
7	DTR *	Data-	Rx-
8	---	---	---
9	GND	GND	GND
10	---	---	---

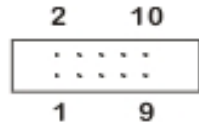

* Port 2 only ** Port 4 only

Serial Port Pin Definition (DB9 Male)

The serial port pin assignment is shown as follow:

Port 1/3: RS-232/485 (software selection)

RS-232: RXD, TXD, RTS, CTS, GND

RS-485: Data+, Data-, GND

Port 2: RS-232/485 (software selection)

RS-232: RXD, TXD, RTS, CTS, DSR, DTR, DCD, GND

RS-485: Data+, Data-, GND

Port 4: RS-232/422/485 (software selection)

RS-232: RXD, TXD, RTS, CTS, GND

RS-422: TXD+, TXD-, RXD+, RXD-, GND

RS-485: Data+, Data-, GND

Pin No.	RS-232	RS-422	RS-485
1	DCD*	TXD-	---
2	RXD	TXD+	---
3	TXD	RXD+	DATA+
4	DTR*	RXD-	DATA-
5	GND	GND	GND
6	DSR*	---	---
7	RTS	---	---
8	CTS	---	---
9	---	---	---

Port 1~4

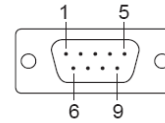

Note: * Port 2 only

Serial Console Port:

Serial console port is used to access M-508 using RS-232. At factory, serial console port is disabled because serial console port shares the COM3 serial port connector with the pin definition as shown:

Pin No.	RS-232
1	---
2	---
3	---
4	---
5	GND
6	---
7	TXD
8	RXD
9	---

Port 3

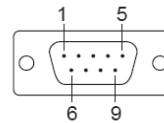

Baud Rate: 115200
Data bits: 8
Parity: N
Stop bit: 1
Terminal type: ANSI

User need to prepare or order a serial console cable (CB-F9F9-100) and enable the serial console port as described in Enable Serial Console port section.

Power Connector

Connect the +5VDC power line to M-508. If the power is properly supply, the power LED will show a solid green color.

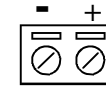

ATTENTION



Please check the power voltage and polarity before connecting it

Ethernet Port

Pin	Signal
1	ETx+
2	ETx-
3	ERx+
6	ERx-

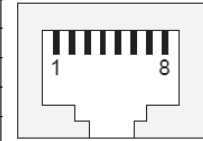

The Ethernet Port uses RJ45 connector

SD Socket

The SD socket is compatible with SD memory card specification version 1.0. The SD Socket is located in the back panel of the PCB.

USB Port

The USB port is a USB2.0 high speed host port. It can be used to expand the hardware function of M-508 and exchange file and data between PC. Currently the hardware support by M-508 USB is shown as follow:

1. USB Storage Device
2. USB to Wireless LAN Adaptor (Ralink RT2571)
3. USB to Modem (CDC compliant)
4. USB Camera

Contact Artilla if you find your hardware is not shown on the list.

Reset Button

Press the “Reset” button to activate the hardware reset. Please always use “reboot” command to reset M-508. You should only use this function if the software reboot does not function properly.

General Purpose IO (GPIO)

GPIO signals are housed in a 20-pin box connector, GPIO1 and GPIO2. Each of the connector includes 16 channels of GPIO. The pin definition is as shown following:

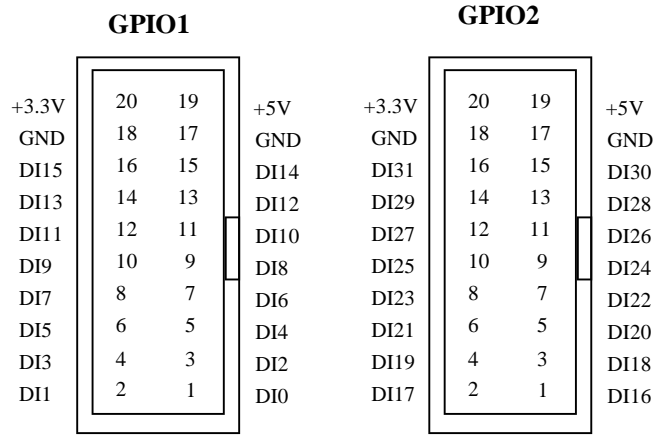

The signal level of GPIO is CMOS level and pitch of the pin header is 2.54 mm. Each of the DIO pin can be programmed as digital input or digital output.

CN1 JTAG Header

JTAG header is located near power connector and it is a 2x4 2.0 mm pin header and the pin definition is shown as follow:



Definition

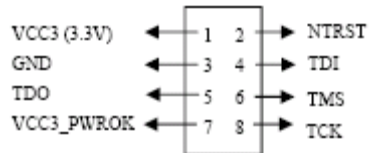

COM2 TTL Header

COM2 TTL is a CMOS/TTL signal pin connector and it is connected to UART of port 2 and its definition is as shown below

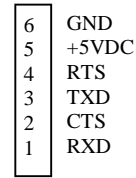

This connector allows user to design an internal Modem to work with M-508.

JP2 Boot manager selection

JP2 is boot selection jumper near CN1. Set to position 2-3 always. Change the setting will cause incorrectly boot up.

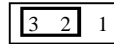

USB Client connector (J3)

USB client port is reserved for future enhancement. This function is disabled by software.

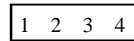

Pin definition is as follow:

1. Data +
2. Data -
3. Host_detect
4. GND

RS-485 terminator jumper (J5,J7,J8,J9)

Short the jumper will enable the 120 ohm terminator as shown below

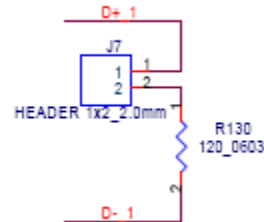

Factory Default Settings

LAN 1 IP Address: 192.168.2.127
Login: guest
Password: guest
Supervisor: root (use ssh to login)
Password: root
Serial Console: Disabled

Network Settings

```
# cat rc
hostname M508
hwclock -s
mount -t proc proc /proc
mount -o remount,rw /dev/root /
mount /sys
mount -t jffs2 /dev/mtdblock5 /mnt/disk-1
ifconfig lo 127.0.0.1
ifconfig eth0 192.168.2.127 netmask 255.255.255.0
route add default gw 192.168.2.254
route add -net 127.0.0.0 netmask 255.255.255.0 lo
sram
cat /etc/motd
```

To configure the IP address, Netmask and Gateway setting, please modify /disk/etc/rc as following:

```
ifconfig eth0 192.168.2.127 netmask 255.255.255.0
```

For DHCP setting:

```
dhcpcd eth1 &
```

Wireless LAN Configuration

M-508 supports wireless LAN by using USB WLAN adaptor which uses Ralink RT2571 (rt73) controller. Please refer to the website <http://ralink.rapla.net> for the supporting list of the USB WLAN adaptor.

To configure the wireless LAN setting, please use command:

```
modprobe rt73
```

```
ifconfig wlan0 up
```

```
iwconfig wlan0 essid XXXX key YYYYYYYY mode MMMM
```

For infrastructure mode XXXX is the access point name and YYYYYYYY is the encryption key and MMMM should be *managed*

For Ad-Hoc mode mode XXXX is the M-508 host name and YYYYYYYY is the encryption key MMMM should be *ad-hoc*.

To configure the IP address use command

```
dhcpcd wlan0 & or ifconfig wlan0 192.168.2.127 netmask 255.255.255.0
```

File System

```
# ls
bin          disk         lib          proc         tmp
default     etc          lost+found /sbin        usr
dev          home        mnt         sys          var
#
```

M-508 configures the root file system as RAMDISK and the user disk (/disk) which includes /home and /etc directory are configured as Flash Disk. To find out the file system information, please use command /mount as shown as below. In addition, use command /df to find out the disk space of the disk. The RAM-DISK uses 8MB SDRAM space to store the root file system and 8MB for uboot loader and Linux Kernel Therefore it is about 16MB free SDRAM for user application software. The image of Linux kernel and root file system is stored in the flash memory and it uses about 4MB flash memory space and the rest of 12MB flash memory is designed for user flash disk to store user's program.

Therefore, user's program and utility software must be saved in the user disk space (/disk). Files saved to other directory **will be**

```
# mount
/dev/ram0 on / type ext2 (rw,nogrpuid)
/dev/mtdblock4 on /mnt/disk type jffs2 (rw,noatime)
/proc on /proc type proc (rw,nodiratime)
/dev/sys on /sys type sysfs (rw)
/dev/mtdblock5 on /mnt/disk-1 type jffs2 (rw,noatime)
/dev/mtdblock6 on /mnt/sram type ext2 (rw,nogrpuid)
# df
Filesystem            1k-blocks    Used Available Use% Mounted on
/dev/ram0              8059         6257    1393    82% /
/dev/mtdblock4        11648         636    11012     5% /mnt/disk
/dev/mtdblock5        16384         644    15740     4% /mnt/disk-1
/dev/mtdblock6         499          13       461     3% /mnt/sram
#
```

The second flash memory is configured as disk-1 and its available space is 15MB. In addition, M-508T is equipped with 512KB FRAM and it is configured as *sram*

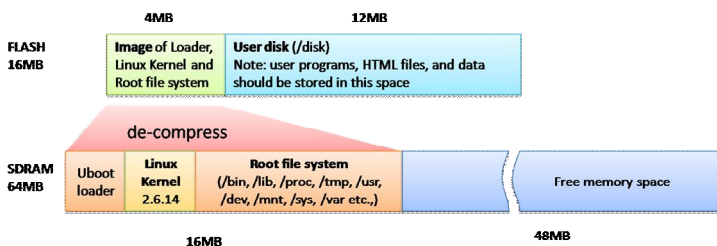

Devices list

The supported devices are shown at /dev directory. Following list are most popular ones:

1. ttyS0: serial console port
2. ttyS1 to ttyS4: serial port 1 to port 4
3. mmc to mmc2: SD memory card
4. sda to sde: USB flash disk
5. ttyUSB0 to ttyUSB1: USB RS-232 adaptor (fdti_sio.ko)
6. rtc: Real Time Clock
7. gpio: General Purpose digital I/O
8. ttyACM0 and ttyACM1: USB Modem (CDC compliant)

```
# cd /dev
# ls
console  mixer      mtdblock4  ptyp1     sda4      tty6      tty2
cua0     mmc       mtdblock5  ptyp2     sdb       tty7      tty3
cua1     nmc0     mtdblock6  ptyp3     sdb1     tty8      tty4
dsp      mmc1     mtdblock7  ptyp4     sdc       tty9      tty5
flash   mmc2     mtdblock8  ptyp5     sdc1     ttyACM0   tty6
gpio    mtd0     mtdblock9  ptyp6     sdd       ttyACM1   tty7
hda     mtd1     mtdr0      ptyp7     sdd1     ttyS0     tty8
hda1    mtd2     mtdr1      ptyp8     sde       ttyS1     tty9
hda2    mtd3     mtdr2     ptyp9     sequencer  ttyS2     urandom
hda3    mtd4     mtdr3     ram0      sndstat   ttyS3     video0
hda4    mtd5     mtdr4     ram1      spi0      ttyS4     video1
ipsec   mtd6     mtdr5     ram2      spi1     ttyS5     watchdog
kmen    mtd7     mtdr6     ram3      tty       ttyS6     zero
lcd     mtd8     mtdr7     random    tty0      ttyS7
ledman  mtd9     mtdr8     rtc       tty1     ttyS8
log     mtblock0 mtdr9     sda       tty2     ttyUSB0
loop0   mtblock1 null      sda1     tty3     ttyUSB1
mem     mtblock2 ppp       sda2     tty4     tty0
midi0   mtblock3 ptyp0     sda3     tty5     tty1
#
```

Utility Software:

M-508 includes busybox utility collection and Artila utility software as follow:

```
# ls /bin
addgroup  crontab  ftpd      ls        pwd       telnetd
adduser  date     gpiotcl  mkdir    rm        tip
angrd    delgroup grep      mke2fs   rmdir    touch
hash     deuser  gunzip   mkfs.jffs2  scp      true
boa      df       gzip     mknod    sed       umount
boa_indexer dhcpcd  hostname mknod    setuart  update
busybox  dhrystone inetd     more     sh        usleep
cat      discard  init     mount    sleep    version
chat     dmesg   iptables mv        snmpd    vi
chgrp   echo     iwconfig netstat  sram     zcat
chmod   egrep   iwlist  ntpdate  sshd
chown   erase   iwpriv  pidof    stty
cp      false  kill    ping     su
cpu     fgrep  ln       pppd     sync
cron    ftp     login   ps       tar

# ls /sbin
adjtimex  ifdown  nakedevs  start-stop-daemon
getty    ifup    nodprobe  sulogin
halt     insmod  reboot    syslogd
hwclock  klogd  rmmod
ifconfig lsmod  route
```

Artila Utility Software:

The introduction of Artila utility software as follow:

1. *update* : update loader, kernel or root file system image. Also use *update* —*FORMAT* to format user disk. Type *update*—*help* to find the command usage

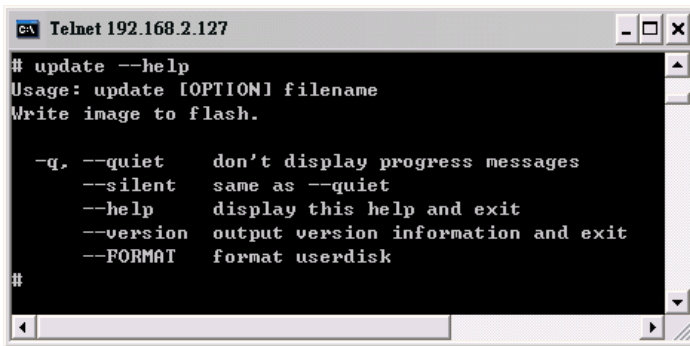

```
cx Telnet 192.168.2.127
# update --help
Usage: update [OPTION] filename
Write image to flash.

  -q, --quiet      don't display progress messages
  --silent        same as --quiet
  --help          display this help and exit
  --version       output version information and exit
  --FORMAT        format userdisk
#
```

Update can only operated under supervisor mode (password : root)

2. *setuart*: configure serial port setting. An example show as followed to configure port 1 as RS-485 interface with baud rate 921600. Please note only port 1 support 9-bit data at RS-485

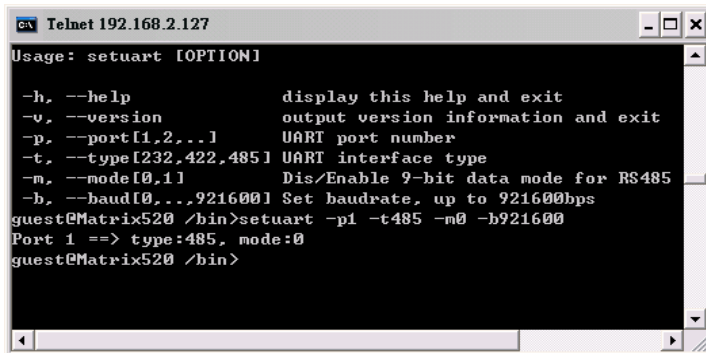

```
cx Telnet 192.168.2.127
Usage: setuart [OPTION]

  -h, --help          display this help and exit
  -v, --version       output version information and exit
  -p, --port[1,2,..]  UART port number
  -t, --type[232,422,485]  UART interface type
  -m, --mode[0,1]     Dis/Enable 9-bit data mode for RS485
  -b, --baud[0,..,921600]  Set baudrate, up to 921600bps
guest@Matrix520 /bin>setuart -p1 -t485 -m0 -b921600
Port 1 ==> type:485, mode:0
guest@Matrix520 /bin>
```

How to make more utility software

You might also find utility software available on Artila CD under /Matrix and iPAC/utility such as *ntpclient*, *ssh*, *scp*, *bluez* and *ssh-keygen*. If you want, you can ftp or copy the utility software to M-508 user disk (/disk). Also you can use find the source code and use the GNU Tool Chain to make the utility by yourself.

Mounting External Storage Memory

To find out the device name of the external memory device which plug into M-508, you can use the command
`/dmesg | grep sd`
or
`/dmesg | grep mmc`
Type
`mount /dev/sda1` to mount the USB disk and
`mount /dev/mmc0` to mount SD card

```
ca Telnet 192.168.2.127
# cat /etc/fstab
/dev/sys      /sys          sysfs        rw      0 0
/dev/sda      /mnt/sda      vfat         rw      0 0
/dev/sda1     /mnt/sda1    vfat         rw      0 0
/dev/sdb      /mnt/sdb      vfat         rw      0 0
/dev/sdb1     /mnt/sdb1    vfat         rw      0 0
/dev/mtdblock3 /mnt/disk    jffs2        rw      0 0
/dev/mmc0     /mnt/mmc     vfat         rw      0 0
#
```

Welcome Message

To modify the welcome message, user can use text edit to modify the /etc/motd.

Web Page Directory

The web pages are placed at /home/httpd and the boa.conf contains the boa web server settings. The home page name should be `index.html`

Adjust the system time

To adjust the RTC time, you can follow the command
`/date MMDDhhmmYYYY`
where
`MM=Month (01~12)`
`DD=Date (01~31)`
`hh=Hour`
`mm=minutes`
`YYYY= Year`
`/hwclock -w`

To write the date information to RTC

User can also use NTP client utility in Artilla CD to adjust the RTC time.

`/ntpclient [time server ip]`

SSH Console

M-508 support SSH. If you use Linux computer, you can use SSH command to login M-508. The configuration of SSH and key are located at
`/etc/config/ssh`
The key generation program is available at Artilla CD
`/matrix` and `ipac /utility/ssh_keygen`
User can copy this program to M-508 to generate the key

```
root@localhost:~/artila/linux-2.6.x
[root@localhost ~]# ssh 192.168.2.127
The authenticity of host '192.168.2.127 (192.168.2.127)' can't be established.
RSA key fingerprint is ba:4b:2d:ae:04:07:bd:c6:5c:4f:8a:43:4b:24:ee:9f.
Are you sure you want to continue connecting (yes/no)? yes
Warning: Permanently added '192.168.2.127' (RSA) to the list of known hosts.
root@192.168.2.127's password:
Welcome to

**          ** **
**          ** **
** **      ** **
** **      **** ** ** *****
** **      ** ** ** ** ** ** **
** **      ** ** ** ** ** ** **
*****    ** ** ** ** ** ** **
** **      ** ** ** ** ** ** **
** **      ** ** ** ** ** ** **

For further information check:
http://www.artila.com/

root@Matrix520 />
```

Install GNU Tool Chain

Find a PC with Linux 2.6.X Kernel installed and login as a **root** user then copy the `arm-linux-3.3.2.tar.gz` to root directory of PC. Under root directory, type following command to install the M-508 Tool Chain
`#tar zxvf arm-linux-3.3.2.tar.gz`

Getting started with the Hello program

There are many example programs in Artilla CD. To compile the sample you can use the Make file to and type
`make`

To compile and link the library. Once done, use ftp command
`ftp 192.168.2.127`

And bin command to set transfer mode to binary

`ftp>bin`

to transfer the execution file to M-508 user disk (/disk) and use

`chmod +x file.o`

Change it to execution mode and

`./file.o`

to run the file

```
[root@localhost ~]# ftp 192.168.2.127
Connected to 192.168.2.127.
220 Matrix520 FTP server (GNU inetutils 1.4.1) ready.
500 'AUTH GSSAPI': command not understood.
500 'AUTH KERBEROS_V4': command not understood.
KERBEROS_V4 rejected as an authentication type
Name (192.168.2.127:root): root
331 Password required for root.
Password:
230- Welcome to
230-
230-          **          ** **
230-          **          ** **
230-          ** **      ** **
230-          ** **      **** ** ** *****
230-          ** **      ** ** ** ** ** ** **
230-          ** **      ** ** **^ ^ ^ ^
230-          *****    ** ** **^ ^ ^ ^
230-          ** **      ** ** **^ ^ ^ ^
230-          ** **      ** ** **^ ^ ^ ^
230-          ** **      ** ** **^ ^ ^ ^

230- For further information check:
230- http://www.artila.com/
230-
230- User root logged in.
Remote system type is UNIX.
Using binary mode to transfer files.
ftp> bi
200 Type set to I.
ftp>
```

Enable Serial Console Port

The serial console port is disabled as factory default setting. To enable the serial console, you need to use the serial console cable (CB-RJ2CON-100) and connect it to port 3. Use any terminal software such as hyper terminal and setting as follow:

Baud Rate: 115200

Data bits: 8

Parity: N

Stop bit: 1

Terminal type: ANSI

Right after powering on the system, keep typing \$ continuously until you see the message as shown in the figure followed. Console (ttyS0) stands for console port ttyS0 is enabled. Repeat this procedure will disable the serial console and screen will show "Console (null)"

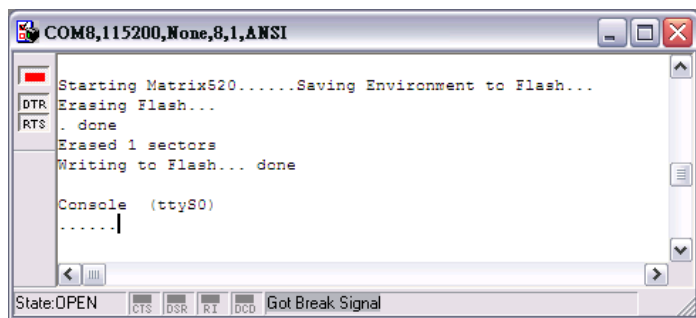

Frequently Asked Question

1. Forgot password:

If you forgot the password for login, please use serial console to modify the password

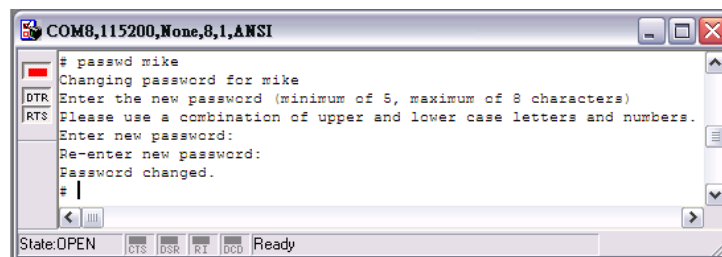

2. Rest M-508 to factory default setting

The factory default setting is available at /default directory. User can copy the default setting to /etc and /home directories manually or format the user disk to set M-508 to factory default setting. Performing disk format will erase all the files in user disk. Therefore please backup the files you need in USBDISK first before format the disk. Use command:

/update —FORMAT

To format disk.

3. Forgot the IP address

If you forgot the M-508 IP address, you can use the Java Manager available in Artilla CD to search the IP address of M-508

Or use serial console port to find out the IP address by

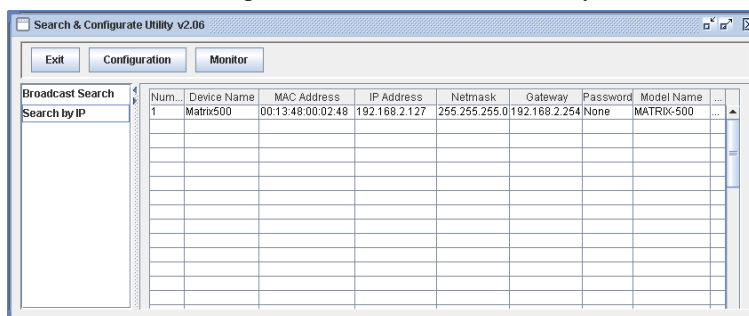

#ifconfig

