

PC-HELPER

Isolated Analog Output Board
for PCI

AO-1604CI3-PCI

User's Guide

CONTEC CO., LTD.

Check Your Package

Thank you for purchasing the CONTEC product.

The product consists of the items listed below.

Check, with the following list, that your package is complete. If you discover damaged or missing items, contact your retailer.

Product Configuration List

- Board [AO-1604CI3-PCI] ...1
- First step guide ...1
- CD-ROM *1 [API-PAC(W32)] ...1

*1 The CD-ROM contains the driver software and User's Guide (this guide)

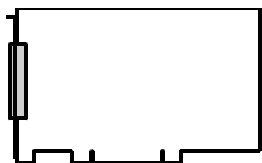

Board

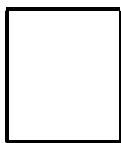

First step guide

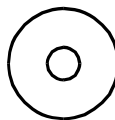

CD-ROM
[API-PAC(W32)]

Copyright

Copyright 2013 CONTEC CO., LTD. ALL RIGHTS RESERVED

No part of this document may be copied or reproduced in any form by any means without prior written consent of CONTEC CO., LTD.

CONTEC CO., LTD. makes no commitment to update or keep current the information contained in this document. The information in this document is subject to change without notice.

All relevant issues have been considered in the preparation of this document. Should you notice an omission or any questionable item in this document, please feel free to notify CONTEC CO., LTD.

Regardless of the foregoing statement, CONTEC assumes no responsibility for any errors that may appear in this document or for results obtained by the user as a result of using this product.

Trademarks

MS, Microsoft, Windows and Windows NT are trademarks of Microsoft Corporation. Other brand and product names are trademarks of their respective holder.

Table of Contents

Check Your Package	i
Trademarks	ii
Table of Contents	iii

1. BEFORE USING THE PRODUCT	1
------------------------------------	----------

About the Product.....	1
Features	1
Support Software.....	2
Cable & Connector (Option).....	3
Accessories (Option)	3
Customer Support.....	4
Web Site.....	4
Limited Three-Years Warranty	4
How to Obtain Service.....	4
Liability.....	4
Safety Precautions	5
Safety Information	5
Handling Precautions.....	6
Environment	8
Inspection.....	8
Storage	8
Disposal	8

2. SETUP	9
-----------------	----------

What is Setup?.....	9
Using the Board under Windows Using the Driver Library API-PAC(W32).....	9
Using the Board under Windows Using Software Other than the Driver Library API-PAC(W32)	9
Using the Board under an OS Other than Windows	10
Step 1 Installing the Software	11
About the driver to be used	11
Starting the Install Program	12
When Using API-AIO(WDM).....	13
When Using API-AIO(98/PC).....	14
Step 2 Setting the Hardware	16
Parts of the Board and Factory Defaults	16
Setting the Board ID	17
Setting the Analog Output.....	18
Plugging the Board	19
Step 3 Installing the Hardware	20

Turning on the PC.....	20
When Using the API-AIO(WDM)	20
When Using the API-AIO(98/PC).....	21
Step4 Initializing the Software.....	25
When Using API-DIO(WDM)	25
When Using API-DIO(98/PC)	27
Step 5 Checking Operations with the Diagnosis Program.....	28
What is the Diagnosis Program?	28
Check Method	28
Using the Diagnosis Program for Use of API-AIO(WDM).....	29
Using the Diagnosis Program for Use of API-AIO(98/PC).....	31
Setup Troubleshooting.....	34
Symptoms and Actions.....	34
If your problem cannot be resolved.....	34

3. EXTERNAL CONNECTION	35
-------------------------------	-----------

How to connect the connectors	35
Connector shape.....	35
Connector Pin Assignment.....	36
Analog Output Signal Connection.....	37
Connecting example of voltage output	37
Connecting example of current output.....	38
Control signals Connection	39
Input signals connection.....	39
Output signals connection.....	41
Surge Voltage Countermeasures.....	43

4. FUNCTIONS	45
---------------------	-----------

Analog Output Function	45
Simple Analog Output.....	45
High-functional analog output.....	49
Starting/Stopping Operation	52
Monitoring the Status	53
Reset.....	54

5. ABOUT SOFTWARE	55
--------------------------	-----------

CD-ROM Directory Structure.....	55
About Software for Windows	56
When using the API-AIO(WDM).....	57
Accessing the Help File.....	57
Using Sample Programs.....	58
Usage of Utility Program	60

When using the API-AIO(98/PC)	63
Accessing the Help File	63
Using Sample Programs	64
Using the Utility Program	66
Uninstalling the Driver Libraries	68
About Software for Linux	69
Driver Software Install Procedure	69
Accessing the Help File	70
Using Sample Programs	70
Uninstalling the driver	70

6.	ABOUT HARDWARE	71
-----------	-----------------------	-----------

For detailed technical information	71
Hardware specification	72
Block Diagram	73
Timing of Sampling Control Signals	74
Signal spec of external sampling clock, external trigger input	74
Timing of external trigger input and input status	74
Timing of external sampling clock and “Settling Busy Output”	75
Timing of “Timer Output”	75
About Calibration	76
Difference from AO-1604CI2-PCI and DAI16-4C(PCI)	76

1. Before Using the Product

About the Product

This product is a PCI bus supported board that extends the analog signal output functions of a PC. Equipped with four channels of 16-bit analog output, the product is an individual isolation model using a D/A converter for each channel to provide isolation for the bus line with PC and between channels. The voltage/current output range (voltage : $\pm 10\text{V}$, 0 - $+10\text{V}$; current : 0 - 20mA) can be set by jumper for each channel. This product can generate signals that are synchronized with the internal timer or an external clock. Windows/Linux driver is bundled with this product.

Using the dedicated library VI-DAQ makes it possible to create each application for LabVIEW.

Features

- Analog output 4ch, 16bit-resolution, conversion speed $20\mu\text{ sec}$

This product has the Analog output (4ch, 16bit, $20\mu\text{ sec}$).

Additionally, the voltage/current output range (voltage : $\pm 10\text{V}$, 0 - $+10\text{V}$, current : 0 - 20mA) can be set by jumper for each channel.

- PC bus line, opto-coupler isolation between channels

The opto-couplers mounted for each channel provide electric isolation between channels as well as between the inside of the board (PC) and output pins.

- Simultaneous output of voltage to a specified channel or all channels

This product can generate output voltage either for a specified channel only or for all of the channels simultaneously. This can be selected or set by software.

- Windows/Linux compatible driver libraries are attached.

Using the attached driver library API-PAC(W32) makes it possible to create applications of Windows/Linux. In addition, a diagnostic program by which the operations of hardware can be checked is provided.

- Control of sampling start/stop can be selected by an external trigger or other factor

Control of sampling start can be selected by software or an external trigger. Control of sampling start and control of sampling stop are independent from each other; therefore, they can be set separately.

Control of sampling stop can be selected by completion of a specified number of sessions or an external trigger. In addition, when an error occurs, sampling is stopped, regardless of the settings for sampling stop conditions.

A sampling cycle can be selected from the internal clock (high precision timer mounted on the board) or an external clock (control signal entered from outside).

- Relay provided to control output voltage

The mounted relay prevents unstable output voltage from being generated upon power-up. This protects the connected devices from damage and malfunction, as the output voltage for all the channels is generated via the relay.

LabVIEW is supported by a plug-in of dedicated library VI-DAQ.

Using the dedicated library VI-DAQ makes it possible to create each application for LabVIEW.

Support Software

You should use CONTEC support software according to your purpose and development environment.

Windows version of analog I/O driver **API-AIO(WDM)/API-AIO(98/PC)**

[Stored on the bundled CD-ROM driver library API-PAC(W32)]

These drivers are the Windows version driver library software that provides products in the form of Win32 API functions (DLL). Various sample programs such as Visual Basic and Visual C++, etc and diagnostic program *Useful for checking operation is provided.

For more details on the supported OS, applicable language and new information, please visit the CONTEC's Web site.

Linux version of analog I/O driver **API-AIO(LNX)**

[Stored on the bundled CD-ROM driver library API-PAC(W32)]

The API-AIO(LNX) is the Linux version driver software which provides device drivers (modules) by shared library and kernel version. Various sample programs of gcc are provided.

For more details on the supported OS, applicable language and new information, please visit the CONTEC's Web site.

Data acquisition VI library for LabVIEW **VI-DAQ**

(Available for downloading (free of charge) from the CONTEC web site.)

This is a VI library to use in National Instruments LabVIEW.

VI-DAQ is created with a function form similar to that of LabVIEW's Data Acquisition VI, allowing you to use various devices without complicated settings.

For more details on the library and download of VI-DAQ, please visit the CONTEC's Web site.

Cable & Connector (Option)

Flat Cable with One 37-pin D- SUB Connector	: PCA37P-1.5 (1.5m)
Shielded Cable with One 37-pin D- SUB Connector	: PCA37PS-0.5P (0.5m)
	: PCA37PS-1.5P (1.5m)
Flat Cable with Two 37-pin D- SUB Connectors	: PCB37P-1.5 (1.5m)
Shielded Cable with Two 37-pin D- SUB Connectors	: PCB37PS-0.5P (0.5m)
	: PCB37PS-1.5P (1.5m)
D-SUB37P Male Connector Set (5pieces)	: CN5-D37M

Accessories (Option)

Screw Terminal (M3 x 37P)	: EPD-37A *1*2
Screw Terminal (M3.5 x 37P)	: EPD-37 *1
General Purpose Terminal (M3 x 37P)	: DTP-3C *1
Screw Terminal (M2.5 x 37P)	: DTP-4C *1

*1 PCB37PS -*P optional cable is required separately (0.5m is recommended.).

*2 "Spring-up" type terminal is used to prevent terminal screws from falling off.

* Check the CONTEC's Web site for more information on these options.

Customer Support

CONTEC provides the following support services for you to use CONTEC products more efficiently and comfortably.

Web Site

<https://www.contec.com/>

Latest product information

CONTEC provides up-to-date information on products.

CONTEC also provides product manuals and various technical documents in the PDF.

Free download

You can download updated driver software and differential files as well as sample programs available in several languages.

Note! For product information

Contact your retailer if you have any technical question about a CONTEC product or need its price, delivery time, or estimate information.

Limited Three-Years Warranty

CONTEC products are warranted by CONTEC CO., LTD. to be free from defects in material and workmanship for up to three years from the date of purchase by the original purchaser.

Repair will be free of charge only when this device is returned freight prepaid with a copy of the original invoice and a Return Merchandise Authorization to the distributor or the CONTEC group office, from which it was purchased.

This warranty is not applicable for scratches or normal wear, but only for the electronic circuitry and original boards. The warranty is not applicable if the device has been tampered with or damaged through abuse, mistreatment, neglect, or unreasonable use, or if the original invoice is not included, in which case repairs will be considered beyond the warranty policy.

How to Obtain Service

For replacement or repair, return the device freight prepaid, with a copy of the original invoice. Please obtain a Return Merchandise Authorization number (RMA) from the CONTEC group office where you purchased before returning any product.

* No product will be accepted by CONTEC group without the RMA number.

Liability

The obligation of the warrantor is solely to repair or replace the product. In no event will the warrantor be liable for any incidental or consequential damages due to such defect or consequences that arise from inexperienced usage, misuse, or malfunction of this device.

Safety Precautions

Understand the following definitions and precautions to use the product safely.

Safety Information

This document provides safety information using the following symbols to prevent accidents resulting in injury or death and the destruction of equipment and resources. Understand the meanings of these labels to operate the equipment safely.

⚠ DANGER	DANGER indicates an imminently hazardous situation which, if not avoided, will result in death or serious injury.
⚠ WARNING	WARNING indicates a potentially hazardous situation which, if not avoided, could result in death or serious injury.
⚠ CAUTION	CAUTION indicates a potentially hazardous situation which, if not avoided, may result in minor or moderate injury or in property damage.

Handling Precautions

DANGER

Do not use the product where it is exposed to flammable or corrosive gas. Doing so may result in an explosion, fire, electric shock, or failure.

CAUTION

- There are switches and jumpers on this product that need to be set in advance. Be sure to check these before installing this product.
- Only set the switches and jumpers on this product to the specified settings. Otherwise, this product may malfunction, overheat, or cause a failure.
- Do not strike or bend this product. Doing so could damage this product. Otherwise, this product may malfunction, overheat, cause a failure or breakage.
- Do not touch this product's metal plated terminals (edge connector) with your hands. Otherwise, this product may malfunction, overheat, or cause a failure. If the terminals are touched by someone's hands, clean the terminals with industrial alcohol.
- Do not install or remove this product to or from the slot while the computer's power is turned on. Otherwise, this product may malfunction, overheat, or cause a failure. Be sure that the personal computer or the I/O expansion unit power is turned off.
- Make sure that your PC or expansion unit can supply ample power to all the boards installed. Insufficiently energized products could malfunction, overheat, or cause a failure.
- If you use this product in a noisy environment, attach ferrite cores to the I/O cable to stabilize the operation.
- The specifications of this product are subject to change without notice for enhancement and quality improvement. Even when using the product continuously, be sure to read the manual and understand the contents.
- Do not modify the product. CONTEC will bear no responsibility for any problems, etc., resulting from modifying this product.
- Regardless of the foregoing statements, CONTEC is not liable for any damages whatsoever (including damages for loss of business profits) arising out of the use or inability to use this CONTEC product or the information contained herein.
- Regarding "CE EMC Directive Notice"
Please connect the Interface Connector with a shielded cable to meet the mentioned standard above. The ferrite core must be installed in connecting cable so that this product may suit the above-mentioned standard.

Name	Maker	Turn	Quantity	Installation Site
E04SR301334 *	SEIWA	1	1	on interface cable at product side

* Equivalent product can also be used.

Image diagram

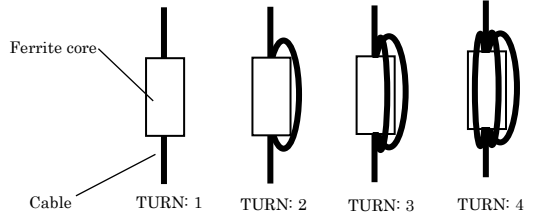
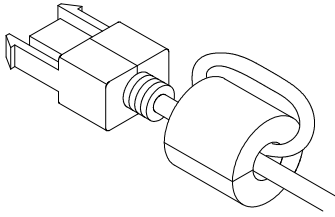

Environment

Use this product in the following environment. If used in an unauthorized environment, the board may overheat, malfunction, or cause a failure.

Operating temperature

0 - 50°C

Operating humidity

10 - 90%RH (No condensation)

Corrosive gases

None

Floating dust particles

Not to be excessive

Inspection

Inspect the product periodically as follows to use it safely.

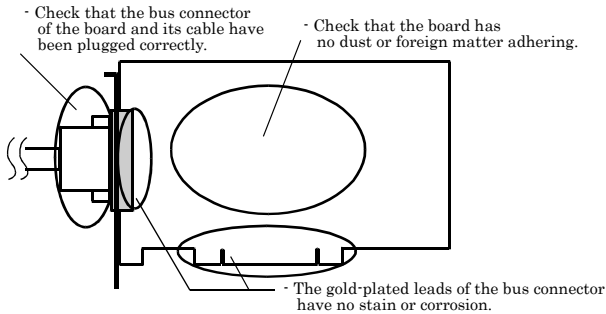

Storage

When storing this product, keep it in its original packing form.

- (1) Put the board in the storage bag.
- (2) Wrap it in the packing material, then put it in the box.
- (3) Store the package at room temperature at a place free from direct sunlight, moisture, shock, vibration, magnetism, and static electricity.

Disposal

When disposing of the product, follow the disposal procedures stipulated under the relevant laws and municipal ordinances.

2. Setup

This chapter explains how to set up the board.

What is Setup?

Setup means a series of steps to take before the product can be used.

Different steps are required for software and hardware.

The setup procedure varies with the OS and applications used.

Using the Board under Windows

Using the Driver Library API-PAC(W32)

This section describes the setup procedure to be performed before you can start developing application programs for the board using the bundled CD-ROM “Driver Library API-PAC(W32)”.

Taking the following steps sets up the software and hardware. You can use the diagnosis program later to check whether the software and hardware function normally.

Step 1 Installing the Software

Step 2 Setting the Hardware

Step 3 Installing the Hardware

Step 4 Initializing the Software

Step 5 Checking Operations with the Diagnosis Program

If Setup fails to be performed normally, see the “Setup Troubleshooting” section at the end of this chapter.

Using the Board under Windows

Using Software Other than the Driver Library API-PAC(W32)

For setting up software other than API-PAC(W32), refer to the manual for that software. See also the following parts of this manual as required.

This chapter Step 2 Setting the Hardware

This chapter Step 3 Installing the Hardware

Chapter 3 External Connection

Chapter 6 About Hardware

Using the Board under an OS Other than Windows

For using the board under Linux, see the following parts of this manual.

This chapter Step 2 Setting the Hardware

Chapter 3 External Connection

Chapter 5 About Software

Chapter 6 About Hardware

For using the board under an OS other than Windows and Linux, see the following parts of this manual.

This chapter Step 2 Setting the Hardware

Chapter 3 External Connection

Chapter 6 About Hardware

Step 1 Installing the Software

This section describes how to install the Driver libraries.

Before installing the hardware on the PC, install the driver library from the API-PAC(W32) CD-ROM provided with the board.

The following description assumes the operating system as Windows XP. Although some user interfaces are different depending on the OS used, the basic procedure is the same.

About the driver to be used

Two Analog I/O drivers are available : API-AIO(WDM) and API-AIO(98/PC).

API-AIO(WDM) is a new driver to perform analog I/O under Windows.

API-AIO(WDM) was developed to improve the conventional product version of API-AIO(98/PC) in the ease of use and functionality.

It is advisable to use API-AIO(WDM) for you to use an analog I/O device. API-AIO(WDM) will support new OS and devices in the future but will not support Windows NT 4.0, Windows 95, ISA bus. Use API-AIO(98/PC) if your operating environment contains such an unsupported piece of software or hardware.

Check the following selection guide to easily select the driver to be used.

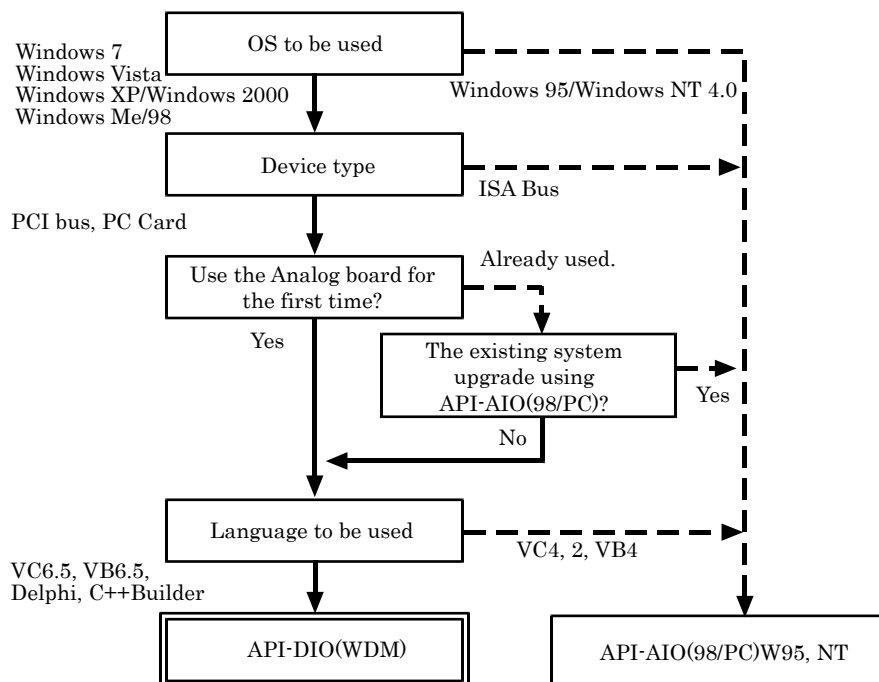

Starting the Install Program

- (1) Load the CD-ROM [API-PAC(W32)] on your PC.
- (2) The API-PAC(W32) Installer window appears automatically.
If the panel does not appear, run (CD-ROM drive letter):\AUTORUN.exe.
- (3) Click on the [Install Development or Execution Environment] button.

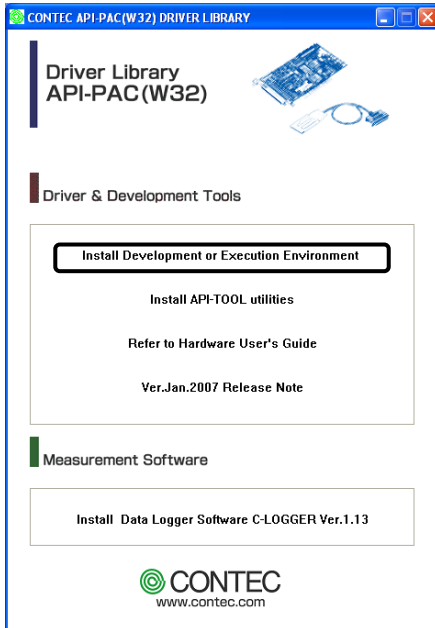

* When using the Windows Vista, driver is automatically installed.

CAUTION

Before installing the software in Windows 7, Vista, XP, Server 2003, 2000, log in as a user with administrator privileges.

When Using API-AIO(WDM)

Selecting API-AIO(WDM)

- (1) The following dialog box appears to select “Driver to install” and “Install option”, “Usage of driver library”.
- (2) Select the "Advanced Analog I/O driver".
- (3) Click on the [Install] button.

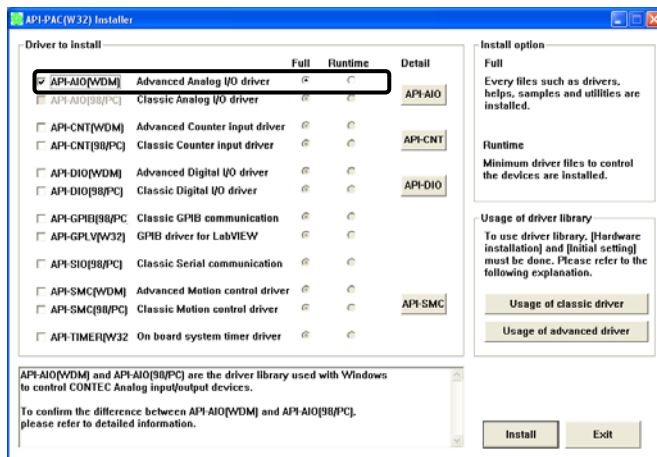

- * Clicking the [API-AIO] button displays detailed information about API-AIO(WDM) and API-AIO(98/PC).

Run the installation

- (1) Complete the installation by following the instructions on the screen.
- (2) The Readme file appears when the installation is complete.

When Using API-AIO(98/PC)

Selecting API-AIO(98/PC)

- (1) The following dialog box appears to select “Driver to install” and “Install option”, “Usage of driver library”.
- (2) Select “Classic Analog I/O driver”.
- (3) Click on the [Install] button.

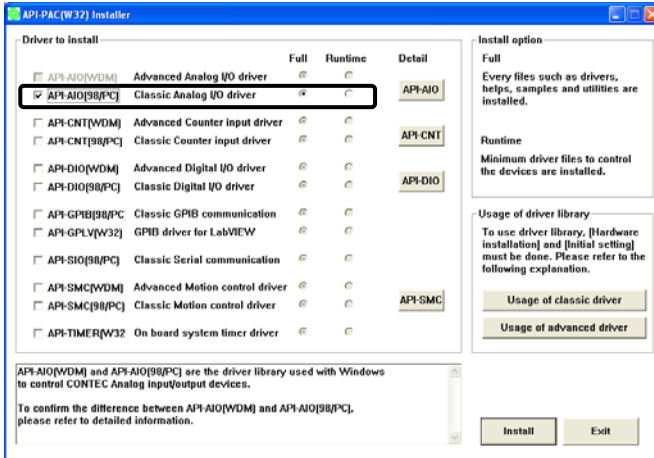

- * Clicking on the [API-AIO] button displays detailed information on API-AIO(WDM), API-AIO(98/PC).

Executing the Installation

- (1) **Follow the on-screen instructions to proceed to install.**
- (2) When the required files have been copied, the “Perform a hardware setup now(API-TOOL Configuration)” and “Show readme file” check boxes are displayed.

When you are installing the software or hardware for the first time:

1) **Uncheck “Perform a hardware setup now”.**

2) **Click on the [Finish] button.**

Go to Step 2 to set and plug the hardware.

* When the hardware has already been installed:

Check “Perform a hardware setup now(API-TOOL Configuration)”, then go to Step 4 “Initializing the Software”.

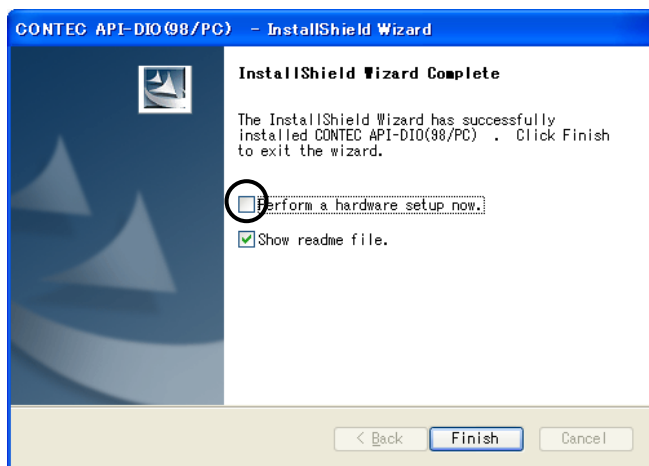

You have now finished installing the software.

Step 2 Setting the Hardware

This section describes how to set the board and plug it on your PC.

The board has some switches and jumper to be preset.

Check the on-board switches and jumpers before plugging the board into an expansion slot.

The board can be set up even with the factory defaults untouched. You can change board settings later.

Parts of the Board and Factory Defaults

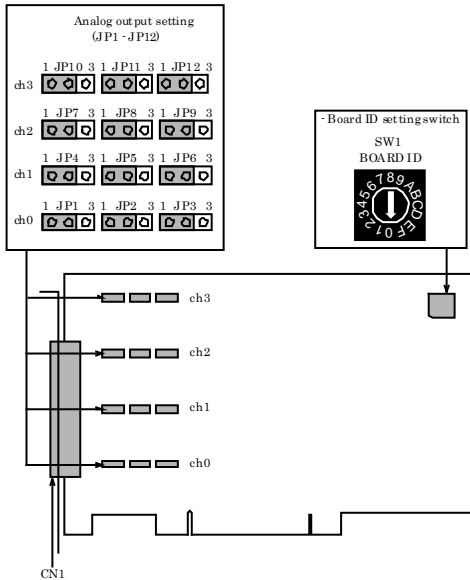

Figure 2.1. Part Names

Note that the jumper and switch setting shown below is the factory default.

Setting the Board ID

If you install two or more boards on one personal computer, assign a different ID value to each of the boards to distinguish them.

The board IDs can be set from 0 - Fh to identify up to sixteen boards.

If only one board is used, the original factory setting (Board ID = 0) should be used.

Setting Procedure

To set the board ID, use the rotary switch on the board. Turn the SW1 knob to set the board ID as shown below.

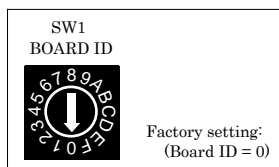
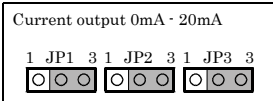
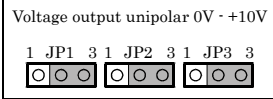
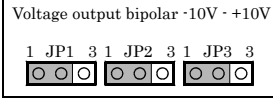

Figure 2.2. Board ID Settings (SW1)

Setting the Analog Output

The analog output is set by specifying the output range. The output range indicates the range of voltages of analog output signals. This product converts digital signals into voltages in the preset output range according to the resolution. It is not possible to set a different output range for each channel.

- ch0 setting



- ch1 setting

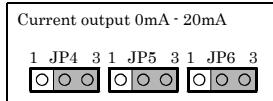
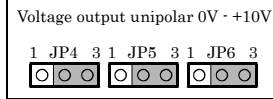
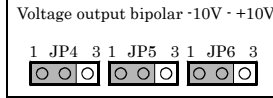

- ch2 setting

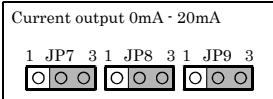
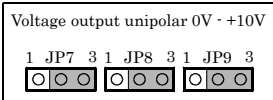
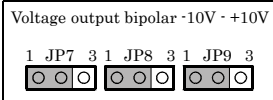

- ch3 setting

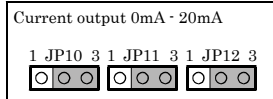
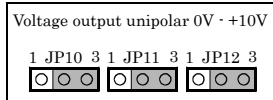
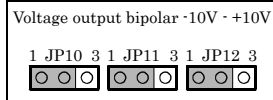

Figure 2.3. Output range setting



CAUTION

Do not set the jumpers to any strapping pattern other than those specified above. Doing so can result in a fault in this product.

Plugging the Board

- (1) Before plugging the board, shut down the system, unplug the power code of your PC.
- (2) Remove the cover from the PC so that the board can be mounted.
- (3) Plug the board into an expansion slot.
- (4) Attach the board bracket to the PC with a screw.
- (5) Put the cover back into place.



Applicable PCI bus slots

PCI bus slots used in PCs have keys to prevent 5V and 3.3V PCI bus boards from being accidentally plugged into wrong bus slots. This board can be plugged into both of the 5V and 3.3V PCI bus slots.

<PCI bus slot>

5-V PCI bus slot

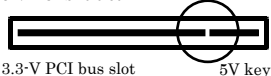

3.3-V PCI bus slot

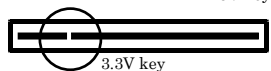

<PCI bus board>

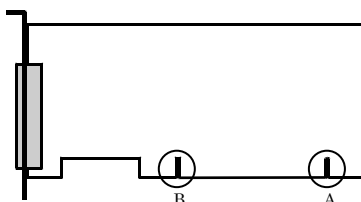

A : Slit for 5-V PCI bus slot
B : Slit for 3.3-V PCI bus slot

⚠ CAUTION

- Do not touch the board's metal plated terminals (edge connector) with your hands. Otherwise, the board may malfunction, overheat, or cause a failure. If the terminals are touched by someone's hands, clean the terminals with industrial alcohol.
- Do not install or remove the board to or from the slot while the computer's power is turned on. Otherwise, the board may malfunction, overheat, or cause a failure. Doing so could cause trouble. Be sure that the personal computer or the I/O expansion unit power is turned off.
- Make sure that your PC or expansion unit can supply ample power to all the boards installed. Insufficiently energized boards could malfunction, overheat, or cause a failure.
- Power supply from the PCI bus slot at +5V is required.

Step 3 Installing the Hardware

Windows needs to detect the I/O address and interrupt used by the board. This is called hardware installation.

When using more than one board, install the boards one at a time and do not install the next board until setup is complete for the previous board.

Turning on the PC

Turn on the power to your PC.

CAUTION

- The board cannot be properly installed unless the resources (I/O addresses and interrupt level) for the board can be allocated. Before attempting to install the board, first determine what PC resources are free to use.
 - The resources used by each board do not depend on the location of the PCI bus slot or the board itself. If you remove two or more boards that have already been installed and then remount one of them on the computer, it is unknown that which one of the sets of resources previously assigned to the two boards is assigned to the remounted board. In this case, you must check the resource settings.
-

When Using the API-AIO(WDM)

- (1) The “Found New Hardware Wizard” will be started.
Select “Install from a list or specific location[Advanced]”, then click on the [Next] button.



- (2) Specify that folder on the CD-ROM which contains the setup information file (INF) to register the board.



⚠ CAUTION

Note that the displayed board name is "DAI16-4C(PCI)" even though you have installed this board. There is no problem in operation even if the board name is displayed as "DAI16-4C(PCI)".

Source folder

The setup information file (INF) is contained in the following folder on the bundled CD-ROM.

\INF\WDM\AIO

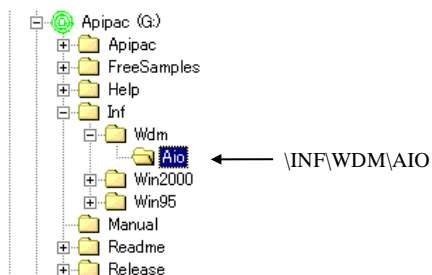

You have now finished installing the software.

When Using the API-AIO(98/PC)

- (1) The “Found New Hardware Wizard” will be started.
Select “Specify the location of the driver (Advanced)”, then click on the [Next] button.
**If you are using Windows NT 4.0, the “Add New Hardware Wizard” is not started.
Go to Step 4 “Initializing the Software”.**



- (2) Specify that folder on the CD-ROM which contains the setup information file (INF) to register the board.

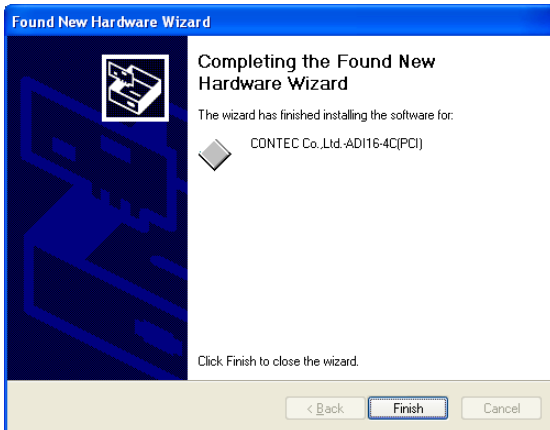

CAUTION

Note that the displayed board name is "DAI16-4C(PCI)" even though you have installed this board. There is no problem in operation even if the board name is displayed as "DAI16-4C(PCI)".

Source folder

The setup information (INF) file is contained in the following folder on the bundled CD-ROM.

Windows Vista, XP, Server 2003, 2000 \INF\Win2000\Aio\PCI

Windows Me, 98, 95 \INF\Win95\Aio\PCI

Example of specifying the folder for use under Windows XP

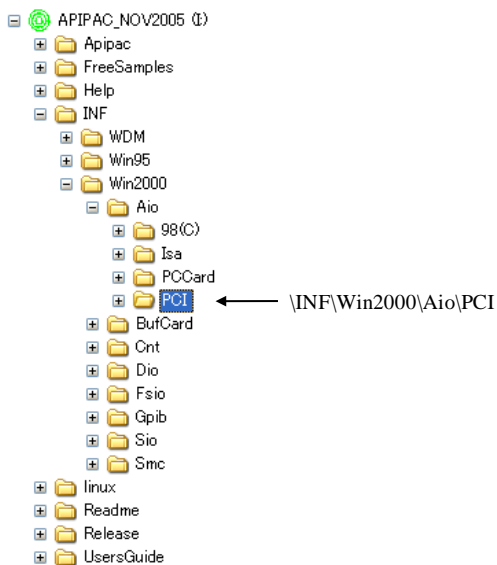

⚠ CAUTION

- In Windows XP, the Hardware Wizard displays the following alert dialog box when you have located the INF file. This dialog box appears, only indicating that the relevant driver has not passed Windows Logo testing, and it can be ignored without developing any problem with the operation of the board.

In this case, click on the [Continue Anyway] button.

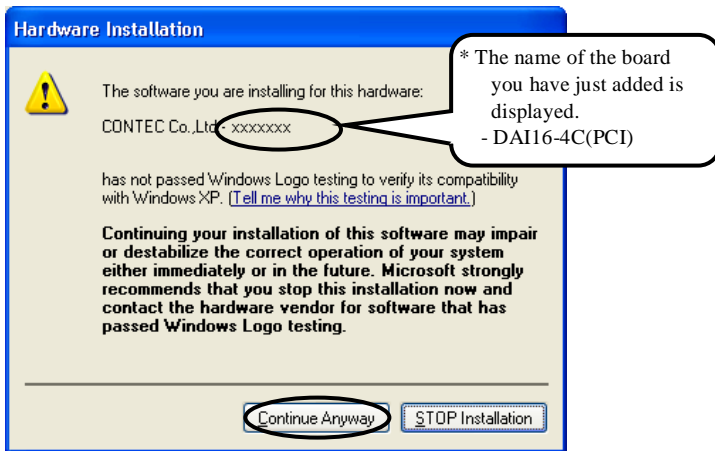

- Note that the displayed board name is "DAI16-4C(PCI)" even though you have installed this board. There is no problem in operation even if the board name is displayed as "DAI16-4C(PCI)".

You have now finished installing the software.

Step4 Initializing the Software

The driver library requires the initial setting to recognize the execution environment. It is called the initialization of the Driver library.

When Using API-DIO(WDM)

Setting the device name

- (1) Run Device Manager. From [My Computer] - [Control Panel], select [System] and then select the [Device Manager] tab.
(You can also open Device Manager by right clicking on My Computer and selecting Properties.)

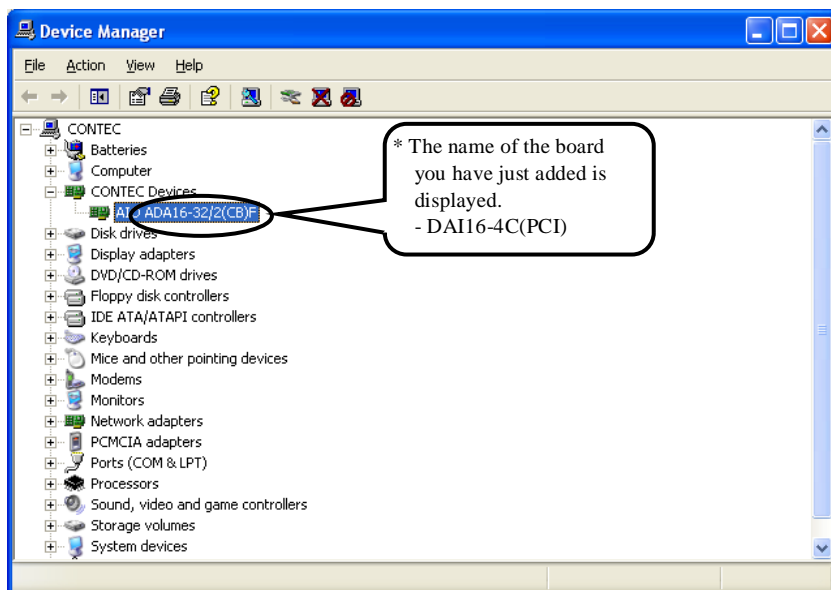

⚠ CAUTION

Note that the displayed board name is "DAI16-4C(PCI)" even though you have installed this board. There is no problem in operation even if the board name is displayed as "DAI16-4C(PCI)".

- (2) The installed hardware appears under the CONTEC Devices node. Open the CONTEC Devices node and select the device you want to setup (the device name should appear highlighted). Click [Properties].

(3) The property page for the device opens.

Enter the device name in the common settings tab page and then click [OK].

The device name you set here is used later when programming.

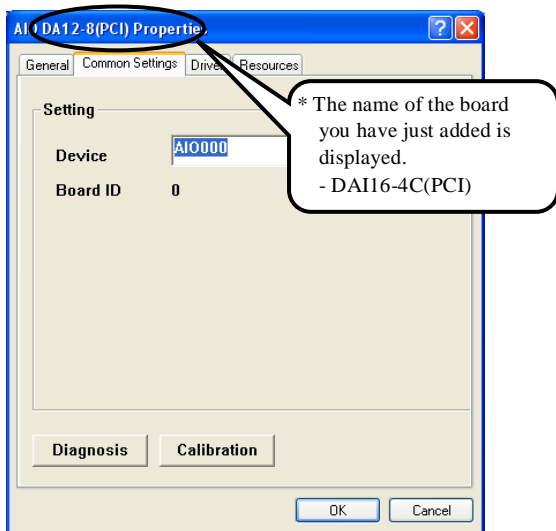

- * The initial device name that appears is a default value. You can use this default name if you wish.
- * Make sure that you do not use the same name for more than one device.

CAUTION

Note that the displayed board name is "DAI16-4C(PCI)" even though you have installed this board. There is no problem in operation even if the board name is displayed as "DAI16-4C(PCI)".

You have now finished installing the initial setting of Software.

When Using API-DIO(98/PC)

API-TOOL Configuration start

- (1) Open the Start Menu, then select “Programs” – “CONTEC API-PAC(W32)” – “API-TOOL Configuration”.

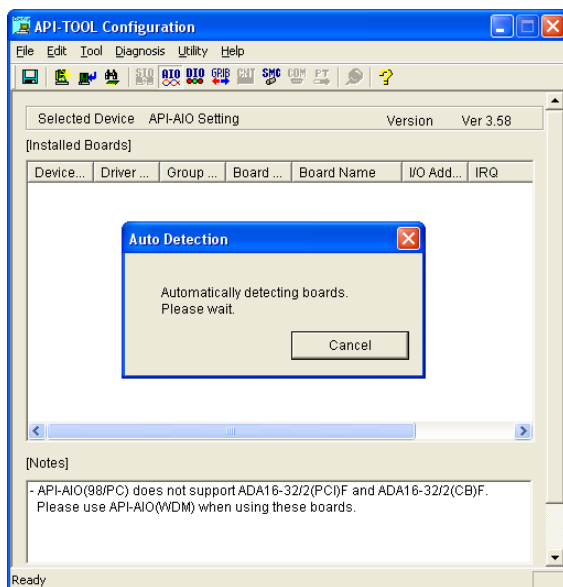

- (2) API-TOOL Configuration detects boards automatically.
The detected boards are listed.

Updating the Settings

- (1) Select “Save setting to registry...” from the “File” menu.

You have now finished installing the initial setting of Software.

Step 5 Checking Operations with the Diagnosis Program

Use the diagnosis program to check that the board and driver software work normally, thereby you can confirm that they have been set up correctly.

What is the Diagnosis Program?

The diagnosis program diagnoses the states of the board and driver software.

It can also be used as a simple checker when an external device is actually connected.

Using the “Diagnosis Report” feature reports the driver settings, the presence or absence of the board, I/O status, and interrupt status.

Check Method

To check analog I/O data, connect the signal.

The diagrams below show examples of using channel 0 on the AO-1604CI3-PCI. For details on the connections, see Chapter 3 “External Connection”. Check the board with the factory defaults untouched.

Connection diagram

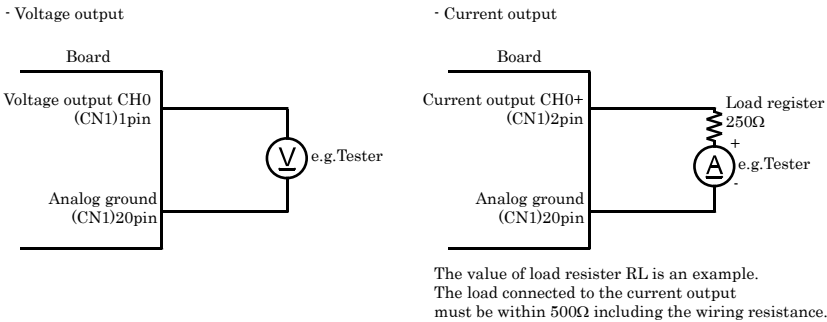

Figure 2.4. Wiring Diagram



CAUTION

Change the setting of the output range with the jumper when you confirm the current output.
Please refer to "Analog Output Setup" on this chapter for details.

Using the Diagnosis Program for Use of API-AIO(WDM)

Starting the Diagnosis Program

Click the [Diagnosis] button on the device property page to start the diagnosis program.

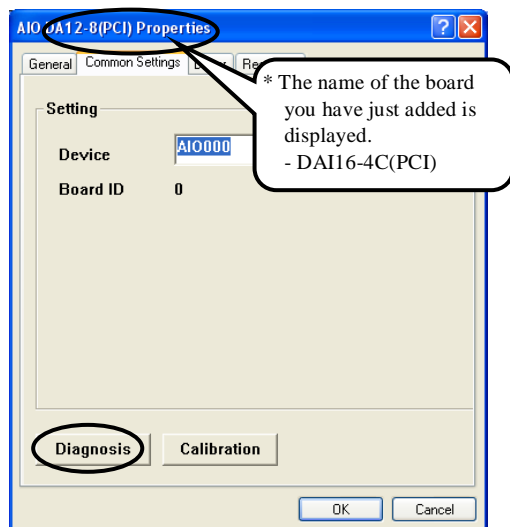

⚠ CAUTION

Note that the displayed board name is "DAI16-4C(PCI)" even though you have installed this board. There is no problem in operation even if the board name is displayed as "DAI16-4C(PCI)".

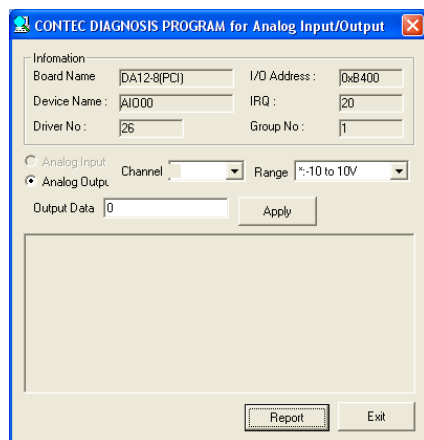

Analog output

You can select the desired output channel, output range from the lists.

You can also select the type of output data from among DC (constant voltage), SIN (sine wave), and Rect (rectangular wave).

Diagnosis Report

(1) The diagnosis report saves detailed data, including the device settings and settings for each channel, to a text file and displays the file for you to view.

Clicking [Diagnosis Report] prompts you to specify where to save the report text file.

```
CAIORep.txt - Notepad
-----
CONTEC Analog I/O diagnostic report
** CAIOdiag.exe program **
Date:2004/05/06 07:08:09
OS :Microsoft Windows XP 5.1.2600 Service Pack 1

[Device Information]
Device Name AI0000
Device ADA16-32/2(CB)F

[File Information]
G:\WINDOWS\SYSTEM32\CAIO.DLL 1, 3, 0, 0 2003/10/31 01:30
G:\WINDOWS\SYSTEM32\MESSAGE.OCX 1, 0, 0, 1 2001/10/26 01:15
G:\WINDOWS\SYSTEM32\CAIOI.DLL 1, 3, 1, 1 2003/05/29 01:13
G:\WINDOWS\SYSTEM32\CAIOPP32.DLL 1, 1, 2, 0 2003/08/27 01:12
G:\WINDOWS\SYSTEM32\DRIVERS\CAIO.SYS 1, 1, 2, 0 2003/10/31 01:30
G:\WINDOWS\SYSTEM32\CAIODIAG.EXE 1, 1, 4, 0 2003/10/31 01:14

[Diagnosis]
Initial result [0] Normality completion
Interrupt [0] Normality completion

Analog Input 32Ch
Input method:singleend
CH00 [0] Normality completion DATA: 3.74(AFE4hex) RANGE:-10 +10V
CH01 [0] Normality completion DATA: 0.16(8200hex) RANGE:-10 +10V
CH02 [0] Normality completion DATA: -0.70(7701hex) RANGE:-10 +10V
CH03 [0] Normality completion DATA: -0.53(793Dhex) RANGE:-10 +10V
CH04 [0] Normality completion DATA: -0.39(7419hex) RANGE:-10 +10V
CH05 [0] Normality completion DATA: -0.75(7659hex) RANGE:-10 +10V
CH06 [0] Normality completion DATA: -0.63(77FChex) RANGE:-10 +10V
CH07 [0] Normality completion DATA: -0.28(7C60hex) RANGE:-10 +10V
CH08 [0] Normality completion DATA: -0.86(7506hex) RANGE:-10 +10V
CH09 [0] Normality completion DATA: -0.77(7623hex) RANGE:-10 +10V
CH10 [0] Normality completion DATA: -0.43(7A84hex) RANGE:-10 +10V
CH11 [0] Normality completion DATA: -0.21(7050hex) RANGE:-10 +10V
CH12 [0] Normality completion DATA: -0.38(7832hex) RANGE:-10 +10V
CH13 [0] Normality completion DATA: -0.16(7B6Fhex) RANGE:-10 +10V
CH14 [0] Normality completion DATA: -0.12(7E77hex) RANGE:-10 +10V
CH15 [0] Normality completion DATA: -0.34(7BA1hex) RANGE:-10 +10V
CH16 [0] Normality completion DATA: -0.54(7914hex) RANGE:-10 +10V
CH17 [0] Normality completion DATA: -0.44(7A52hex) RANGE:-10 +10V
CH18 [0] Normality completion DATA: -0.52(794Chex) RANGE:-10 +10V
CH19 [0] Normality completion DATA: -0.41(7ACAhex) RANGE:-10 +10V
CH20 [0] Normality completion DATA: -0.68(7747hex) RANGE:-10 +10V
CH21 [0] Normality completion DATA: -0.39(7AF6hex) RANGE:-10 +10V
```

⚠ CAUTION

Note that the displayed board name is "DAI16-4C(PCI)" even though you have installed this board. There is no problem in operation even if the board name is displayed as "DAI16-4C(PCI)".

(2) The diagnosis report contains the following data.

- Version of OS
- Device Information
- File Information
- Diagnosis results for each I/O channel

Execution time measurement

Clicking [Execution Time Measurement] runs the program to measure API function execution speed. The operation of this program is explained in "API function Execution Speed Measurement Program" in Chapter 5.

Using the Diagnosis Program for Use of API-AIO(98/PC)

Starting the Diagnosis Program

After selecting the board in [API-TOOL Configuration], run the diagnosis program. Follow the on-screen instructions.

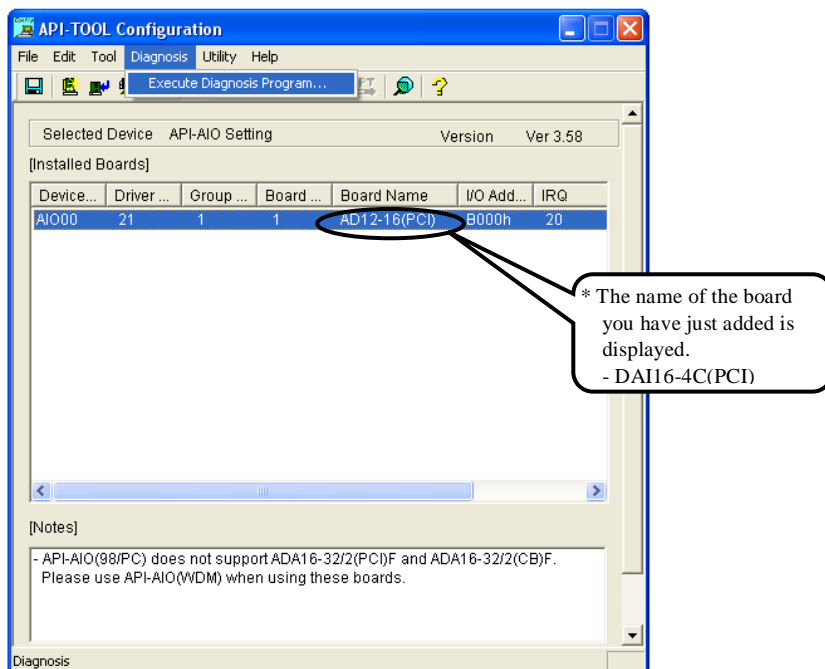

⚠ CAUTION

Note that the displayed board name is "DAI16-4C(PCI)" even though you have installed this board. There is no problem in operation even if the board name is displayed as "DAI16-4C(PCI)".

Checking the Analog Output

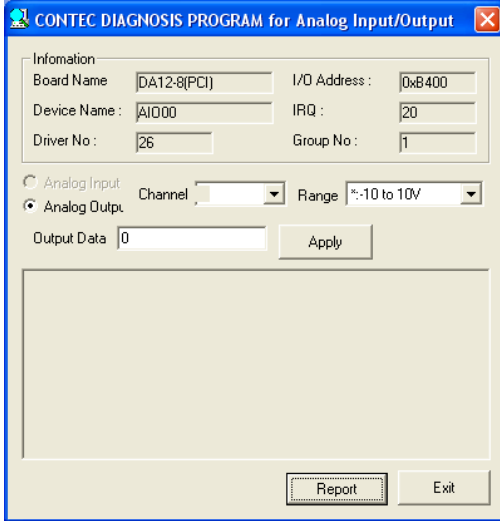

Analog output

You can select the output channel and output range from the lists.

Diagnosis Report

- (1) Clicking on the [Report] button displays detailed data such as a board, channel settings and the diagnosis results while saving them in text format.

The results are saved and displayed as a text file (AioRep.txt) in the install folder (CONTEC/CONTECW95).

The Diagnosis Program performs “board presence/absence check”, “interrupt test”, “driver file test”, “board setting test”, and so on.

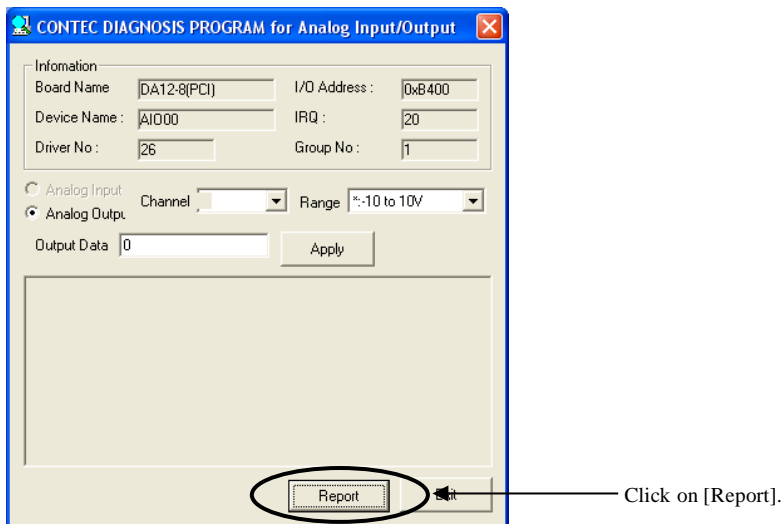

- (2) A diagnosis report is displayed as shown below.

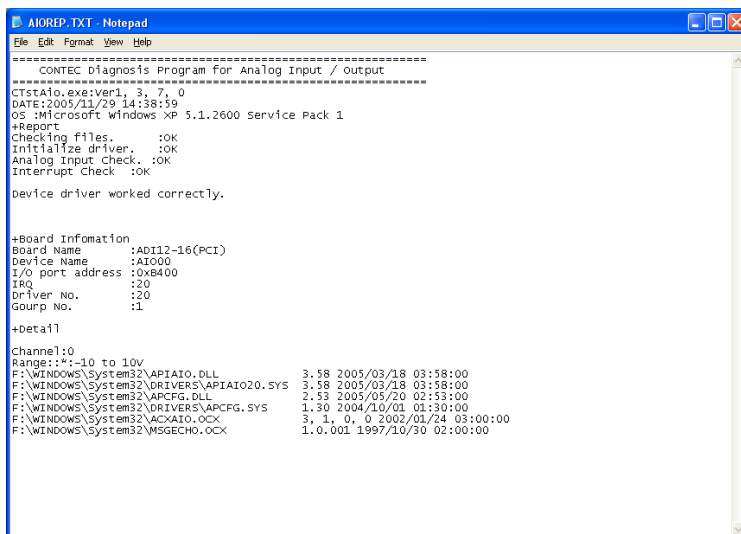

Setup Troubleshooting

Symptoms and Actions

The board cannot be initialized. [Windows NT 4.0]

The driver may not yet be activated. When your PC is running under Windows NT 4.0, set the PnP OS option in the BIOS Setup menu to “NO”.

For details on BIOS settings, refer to the user’s guide for your PC.

The board cannot output data normally

- Run the Diagnosis Program to check whether the board has been registered correctly and whether any initialization error has occurred.
- Check the settings and connections of the board. Also check the output ranges.

The board works with the Diagnosis Program but not with an application.

The Diagnosis Program is coded with API-TOOL functions. As long as the board operates with the Diagnosis Program, it is to operate with other applications as well. In such cases, review your program while paying attention to the following points:

- Check the return values of functions.
- Check the Driver No. and Board No.

The OS won't normally get started or detect the board.

[Windows Vista, Windows XP, Server 2003, 2000]

Turn off the power to your PC, then unplug the board. Restart the OS and delete the board settings of API-TOOL Configuration. Turn off the PC again, plug the board, and restart the OS. Let the OS detect the board and use API-TOOL Configuration to register board settings.

If your problem cannot be resolved

Contact your retailer.

3. External Connection

This chapter describes the interface connectors on the board and the external I/O circuits. Check the information available here when connecting an external device.

How to connect the connectors

Connector shape

The on-board interface connector (CN1) is used when connecting this product and the external devices.

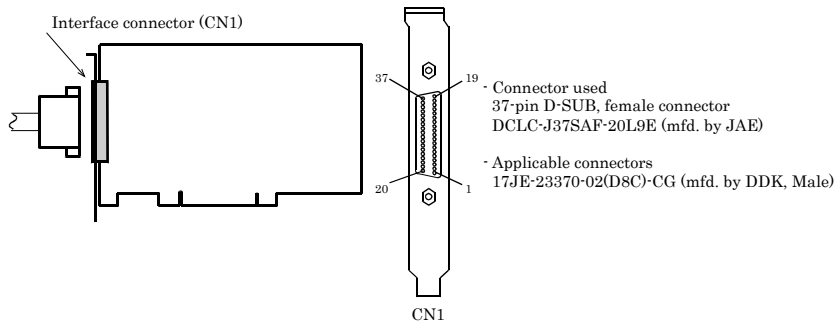

* Please refer to chapter 1 for more information on the supported cable and accessories.

Figure 3.1. Interface Connector Shape

Connector Pin Assignment

Pin Assignments of Interface Connector (CN1)

CN1			
Settling Busy Output	37	19	Plus Common
Timer Output	36	18	External Trigger Input
Minus Common	35	17	External Sampling Clock Input
N.C.	34	16	N.C.
N.C.	33	15	N.C.
Analog Ground 3	32	14	Current Output 3
N.C.	31	13	Voltage Output 3
N.C.	30	12	N.C.
N.C.	29	11	N.C.
Analog Ground 2	28	10	Current Output 2
N.C.	27	9	Voltage Output 2
N.C.	26	8	N.C.
N.C.	25	7	N.C.
Analog Ground 1	24	6	Current Output 1
N.C.	23	5	Voltage Output 1
N.C.	22	4	N.C.
N.C.	21	3	N.C.
Analog Ground 0	20	2	Current Output 0
		1	Voltage Output 0

Voltage Output 0 - Voltage Output3	Analog voltage output signal. The numbers correspond to channel numbers.
Current Output 0 - Current Output 3	Analog current output signal. The numbers correspond to channel numbers.
Analog Ground 0 - Analog Ground 3	Analog grounds for identically numbered output signals.
External Trigger Input	External trigger input signal
External Sampling Clock Input	External sampling clock input signal.
Timer Output	Output signal of programmable timer
Settling Busy Output	Output signal indicating that the board is performing DA conversion.
Plus Common	Connect the plus side of external device. Common for each "External Trigger Input", "External Sampling Clock Input", "Timer Out", " Settling Busy Output " signal.
Minus Common	Connect the minus side of external device. Common for each "Timer Out", " Settling Busy Output" signal.
N.C.	No connection to this pin.

Figure 3.2. Pin Assignments of Interface Connector (CN1)

⚠ CAUTION

Do not connect any of the outputs and power outputs to the analog or digital ground.
Neither connect outputs to each other. Doing either can result in a fault.

Analog Output Signal Connection

The sections below describe how to connect the signals using flat cable and shielded cable.

Connecting example of voltage output

The following figure shows an example of optional flat cable (PCA37P) connection.

Connect the CN1 analog output channels and ground to the external device's input and ground.

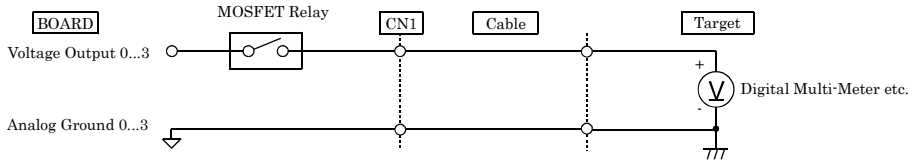

Figure 3.3. Connection of voltage output (Flat Cable)

The following example connects a signal source to the board using a shielded cable. Use shielded cable if the distance between the board and loading is long or if you want to provide better protection from noise. Use the core of the shielded cable to connect the analog output of CN1 to the input of the external device and use the shield braid to connect the CN1's analog ground to the external device's ground.

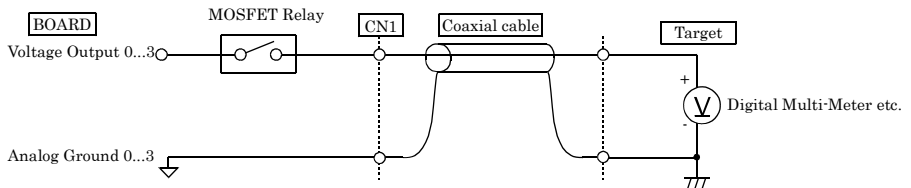

Figure 3.4. Analog Output Connection (Shield Cable)

⚠ CAUTION

- If the board and the target receive noise or the distance between the board and the signal source is too long, data may not be input properly.
- The maximum output current-carrying capacity of the analog output signal is ± 5 mA. Check the specifications of the target before connecting the board to it.
- Do not connect any of the outputs and power outputs to the analog or digital ground.
- Do not connect the analog output signal to the other analog output signal and output signal of external device. Doing so may malfunction.
- Do not plug or unplug the interface connector to or from while the PC or external device power is turned on. Doing so may malfunction.
- The DA converter may cause glitches as it contains no deglitcher.

Connecting example of current output

The figure below shows an example connection using a flat cable as the optional one (PCA37P).

The load register is connected. Please adjust the register load R_L connected with the current output of each channel to 500Ω or less including the resistance of wiring.

Each current output of CN1 and analog ground is connected to the resister load R_L .

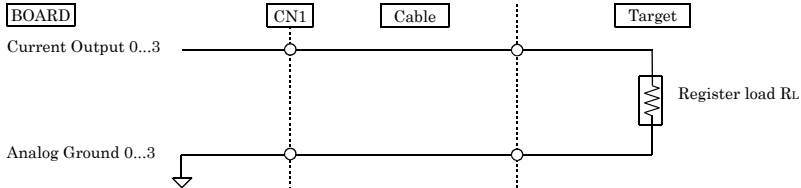

Figure 3.5. Current output connection (Flat cable)

The following figure shows an example of shielded cable connection. Use shielded cable if the distance between the loading and board is long or if you want to provide better protection from noise. Connect the each current output of CN1 to the register load in the core wire of shielded cable and connect the each analog ground of CN1 to the register load in the shielding of shielded cable.

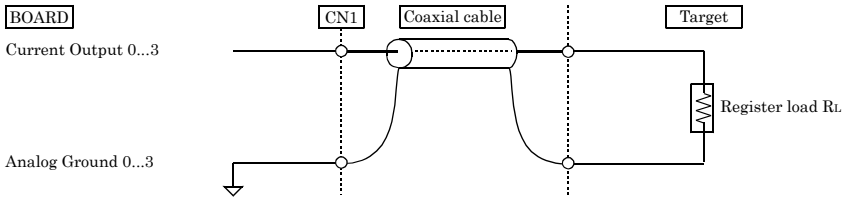

Figure 3.6. Current output connection (Shielded cable)

⚠ CAUTION

- When the power supply is turned on, output (0mA) of data 0000h is output as for the output signal.
- Do not short circuit any of the output signals to analog ground. Doing either can cause a malfunction.
- Do not connect the output signal to that of other channel and of external device. Doing either can cause a malfunction.
- Do not detach the interface connector (CN1) with the power supply of a PC or an external device turned on. Doing either can cause a malfunction.
- If the connection cable is affected by noise, it may fail to output the accurate current data. Route the connection cable as far apart from noise sources as possible.

Control signals Connection

Input signals connection

To the “External Sampling Clock Input” and “External Start Trigger Input”, connect current driven devices such as a switch and a transistor output device. Input circuit is as follows. An external power supply is required to drive the input circuit. The power capacity required at this time is about 11 mA per input channel at 24 VDC (or about 5.5 mA at 12 VDC).

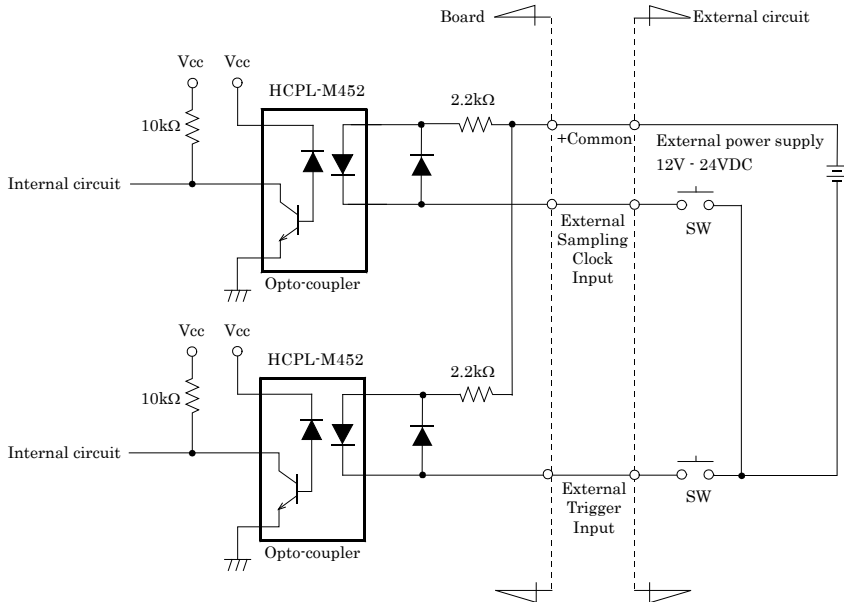

Figure 3.7. Input circuit

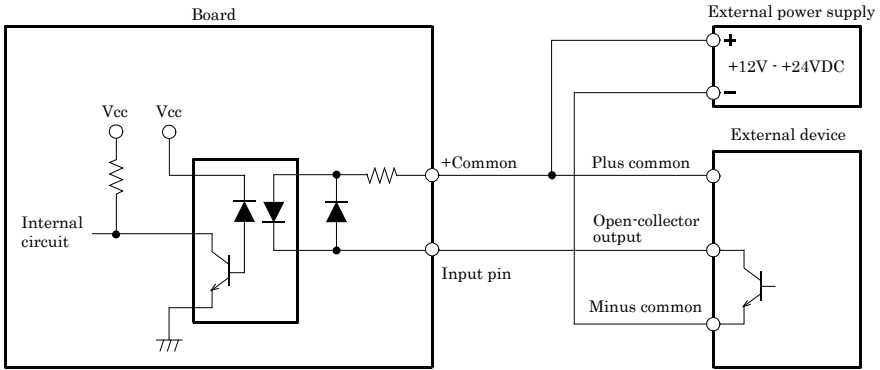

Figure 3.8. Connection example with open-collector output (current sink type)

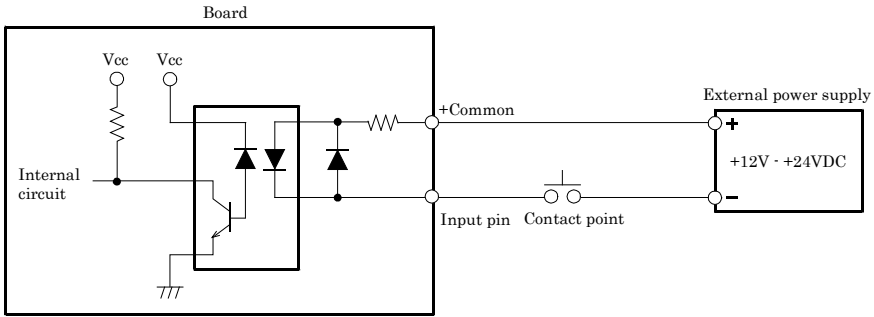

Figure 3.9. Connection example with mechanical contact point

The relation of the data (internal logic) seen from the input signal and the PC side as an example of the above figure is shown below.

Table 3.1. Relation between the input signal and the data (internal logic) seen from the PC side

Internal logic	Contact point	Input pin voltage level
0	OFF	High
1	ON	Low

Reference

For the operation timings for control signal input, see “Timing of External Control Signals” in Chapter 6 “Hardware”.

Output signals connection

To the “Timer Output “ and “Settling Busy Output”, connect a relay controller or a current driven control device such as a LED. Output circuit is as follows.

An external power supply is required to drive the output circuit. The rated output current is up to 50 mA per channel. The output transistor is not associated with a surge voltage protection circuit. When the output signal is used to drive the inductive load to a relay or lamp, apply surge protection to the load side.

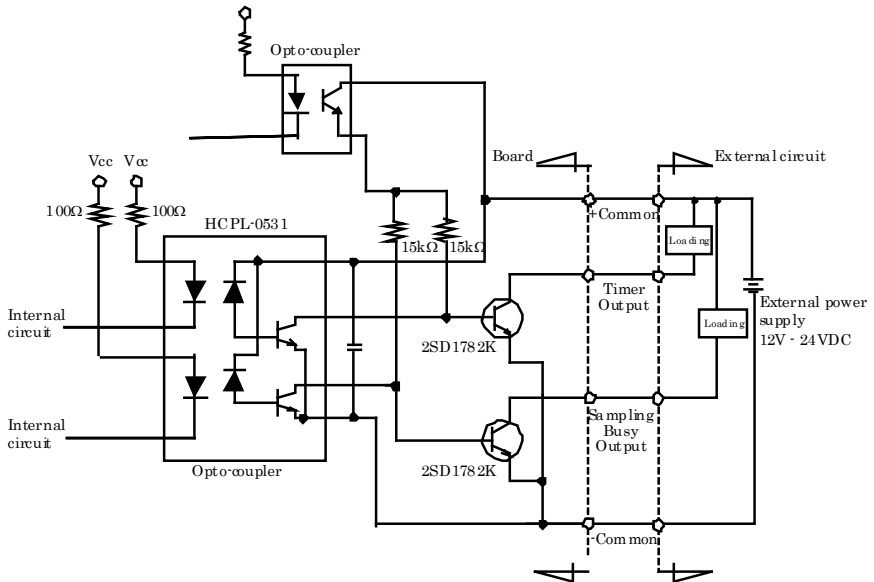

Figure 3.10. Output circuit



CAUTION

When the power supply is turned on, all the outputs are turned off.

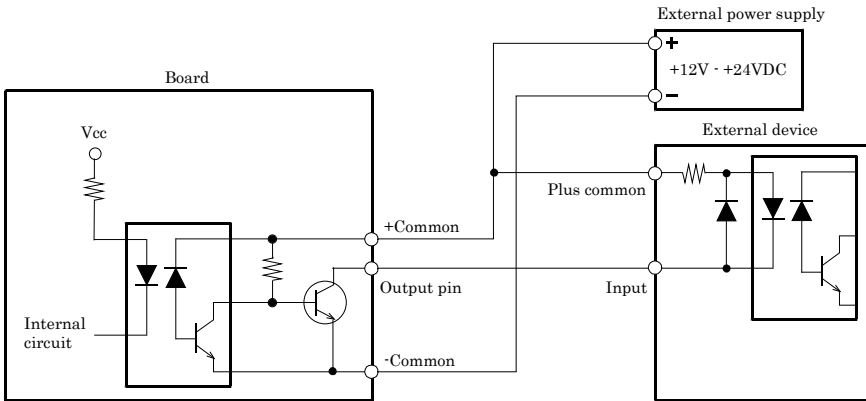

Figure 3.11. Connection example with current sink corresponding input

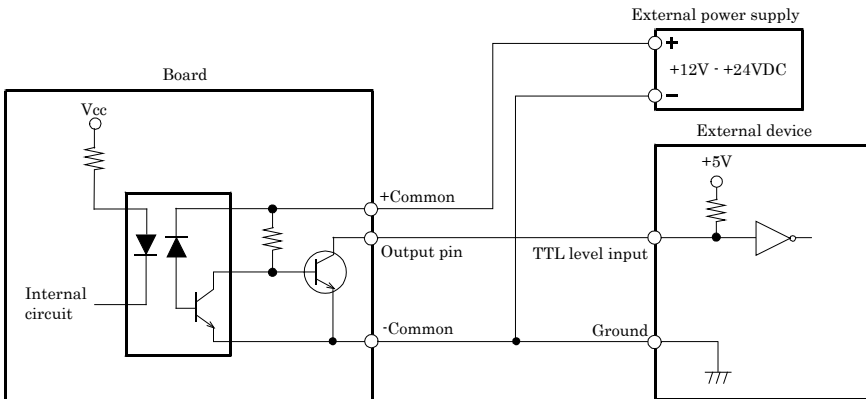
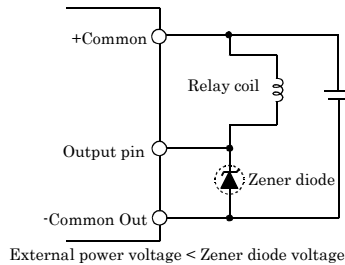
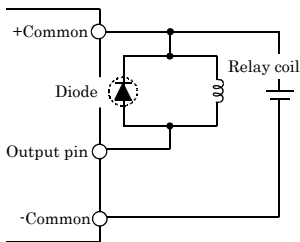

Figure 3.12. Connection example with TTL level input (with pull-up register)

Surge Voltage Countermeasures

When connecting a load that generates surge voltages and inrush currents, such as an induction load (relay coil) or an incandescent light bulb, to the control output signals, appropriate protection must be provided in order to prevent damage to the output stage or a malfunction due to noise. The rapid shutoff of a coil, such as a relay, generates a sudden high-voltage pulse. If this voltage exceeds the voltage tolerance level of the output transistor, it can cause the transistor to gradually deteriorate, or even completely damage the transistor. Therefore, when driving an induction load, such as a relay coil, you should always connect a surge-absorbing device. The following illustrates a surge voltage countermeasure that can be employed:

- Examples of use of relay coil



- Examples of use of lump

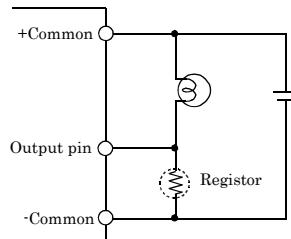
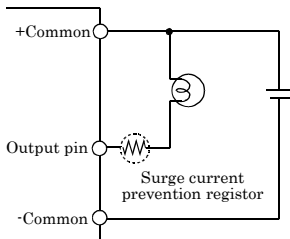

Figure 3.13. Surge Voltage Countermeasure

⚠ CAUTION

In order for a protection circuit to operate effectively, it must be connected within 50cm of a load and a contact point.

4. Functions

This chapter describes the different functions that can be implemented using the hardware and driver together. Unless stated otherwise, the driver is assumed to be API-AIO(WDM).

Analog Output Function

Analog output processes are classified as follows:

- Simple Analog Output
- High-functional analog output

Simple Analog Output

When an analog output start command is executed by software, output data is set for one or more channels, DA conversion is performed, and then the analog output operation is terminated.

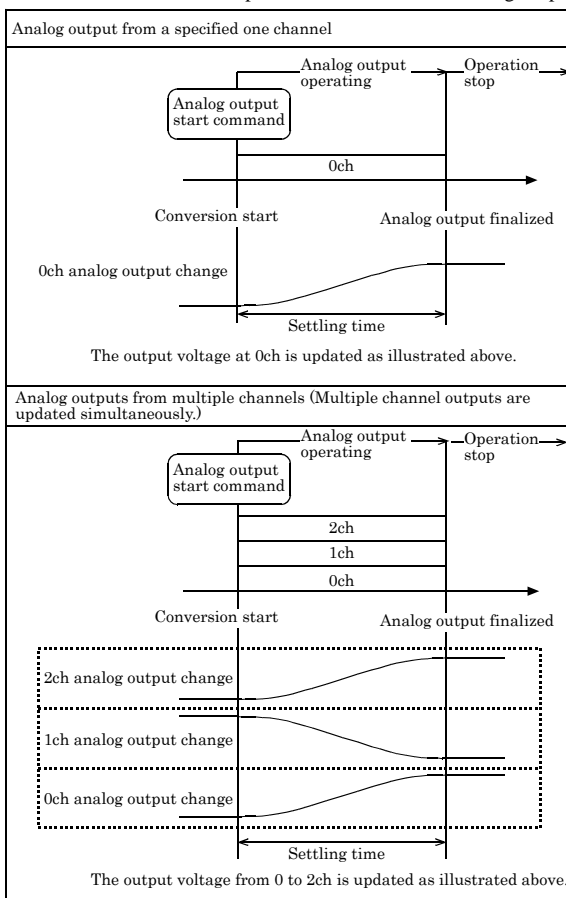

- * The analog output is finalized after the settling time after conversion is started.
The conversion speed is determined by the settling time per channel.

Simple analog output assumes the following conditions and settings.

Resolution

“Resolution” signifies the number of bits used by an analog output device to represent analog signals. The higher the resolution, the more finely the voltage range is segmented, allowing the device to convert to analog value more precisely.

A device with a resolution of 12-bit divides the range width into 4096 segments.

When the device covers the range of 0 to 10V, the minimum unit of converted voltages is $10 \div 4096 \approx 2.44\text{mV}$.

If the device has a resolution of 16-bit, it is $10 \div 65536 \approx 0.153\text{mV}$ instead.

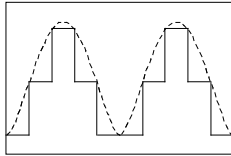

Low-resolution board

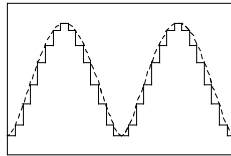

High-resolution board

AO-1604CI3-PCI : The resolution is 16-bit.

Range

“Range” means the range of voltages (current) at which analog output can be performed.

The output range can be selected by setting the output signal type (voltage and current) and the upper and lower output signals.

AO-1604CI3-PCI : Range is set by the jumper setting.

Output data

The following equation represents the relationship between output data and voltage.

$$\text{Output data} = ((\text{voltage} - \text{Min. range value}) \times \text{Resolution}) \div (\text{Max. range value} - \text{Min. range value})$$

The value of resolution for the 12-bit device is 4096; that for the 16-bit device is 65536.

<±10V range>

The table below shows the relationship between output data and voltage.

Voltage	Output data (12-bit)	Voltage	Output data (16-bit)
+9.995V	4095	+9.99970V	65535
:	:	:	:
0.005V	2049	0.00030V	32769
0V	2048	0V	32768
-0.005V	2047	-0.00030V	32767
:	:	:	:
-10.000V	0	-10.000V	0

Ex.: When 3V is output at a resolution of 12-bit in the ± 10-V range

$$\begin{aligned} \text{Output data} &= (3 - (-10)) \times 4096 \div (10 - (-10)) \\ &= 2662.4 * \end{aligned}$$

- * The value that can be set as output data at this time is an integer. Select "2662" or "2663" as the output data.

The analog signal corresponding to the output data contains an error as follows:

- Output data "2662" converted to: 2.9980 V

- Output data "2663" converted to: 3.0029 V

This error is a consequential error occurring when output data is obtained from an expected analog value.

<0 - 10V range>

The table below shows the relationship between output data and voltage.

Voltage	Output data (12-bit)	Voltage	Output data (16-bit)
+9.998V	4095	9.99985V	65535
:	:	:	:
5.002V	2049	5.00015V	32769
5V	2048	5V	32768
4.998V	2047	4.99985V	32767
:	:	:	:
0V	0	0V	0

Ex.: When 3V is output at a resolution of 12-bit in the 0 - 10V range

$$\begin{aligned}\text{Output data} &= (3 - 0) \times 4096 \div (10 - 0) \\ &= 1228.8^*\end{aligned}$$

* The value that can be set as output data at this time is an integer. Select "1228" or "1229" as the output data.

The analog signal corresponding to the output data contains an error as follows:

- Output data "1228" converted to: 2.9980 V

- Output data "1229" converted to: 3.0005 V

This error is a consequential error occurring when output data is obtained from an expected analog value.

Channel

"Channel" represents individual channel No. for analog output signal.

For channel No., see "How to connect the connectors" - "Connector Pin Assignment" in Chapter 3 "External Connection".

For the channel selection, specify the channel No. or the number of channel which you want to convert D into A (channel consecutive from channel 0)

* The above conditions and settings are also required for "high-functional analog output" described on the next page.

High-functional analog output

When an analog output start command is executed by software, DA conversion is performed in synchronization with the sampling clock from when the sampling start condition is met to when the sampling stop condition is met.

The analog output operation stops when the sampling stop condition is met.

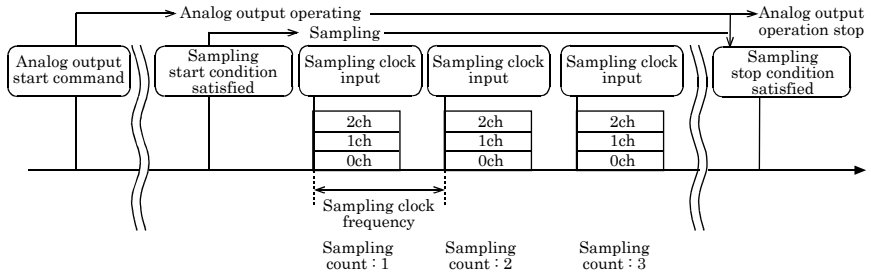

Sampling is defined as a series of operations performed from when the sampling start condition is met to when the sampling stop condition is met.

The number of times DA conversion is executed during sampling is counted as a sampling count.

The sampling count can be used as the sampling stop condition (as described later).

The following settings are required for high-functional analog output:

Sampling clock

The internal or external sampling clock can be selected as the sampling clock that determines the DA conversion period. The sampling clock is selected by means of software.

- Internal sampling clock
The clock signal from the on-board clock generator is used.
- External sampling clock
The edge of the digital signal input from an external device is used for the sampling clock.

Memory

Output data can be stored in driver's memory in advance so that DA conversion can be executed repeatedly. You can select the memory type between FIFO and RING depending on the application of analog output. The memory type is selected with software.

AO-1604CI3-PCI : Uses the memory for storing converted data on the driver.

- FIFO(First In First Out)format
Use FIFO format if you wish to output a continuous arbitrary analog output like that shown below.

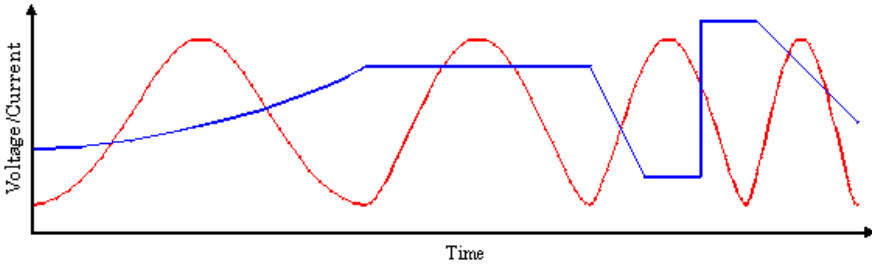

When using FIFO format, writing of conversion data to memory is always performed from after the most recent data and DA conversion is performed on the oldest data in memory.

You can write to memory during analog output operation.

An error occurs if the volume of data exceeds the memory size. However, this error does not stop analog output if it is in progress.

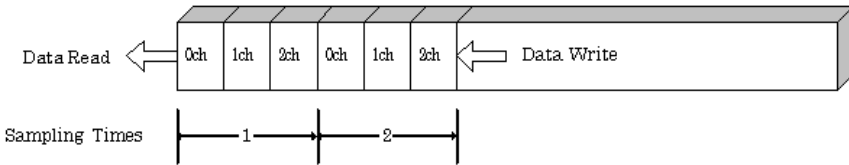

- Ring format
Use ring format if you wish to output a repeated pattern like that shown below.

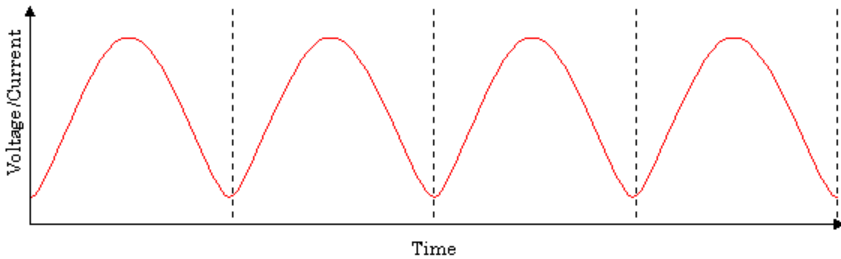

When using ring format, write the data for one complete cycle of the output waveform before starting operation.

You cannot write to the memory during its operation of analog output.

DA conversion data is output continuously in the sequence in which the ring format data is stored.

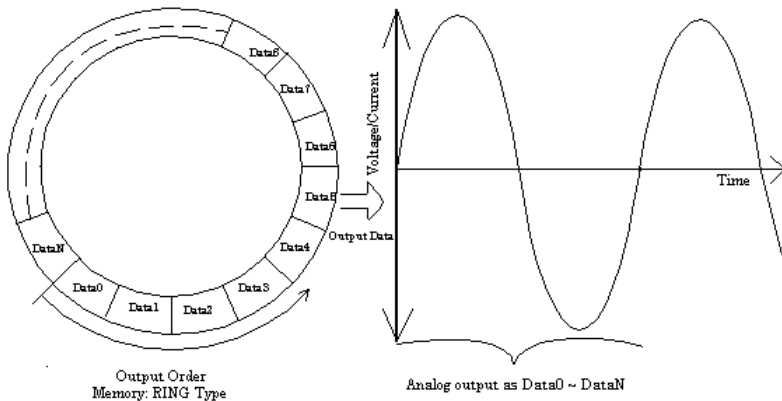

- * Although the figure shows a single analog output channel, output from multiple channels is also possible.

Sampling Start Condition

The condition for controlling the start of sampling can be selected from both software and an external trigger. The conditions for controlling the start and stop of sampling are completely independent of each other; they can be set separately.

- Software
 - The analog output start command executed by software is set as the sampling start condition.
 - The board starts sampling upon execution of the analog output start command.
- External trigger
 - The board starts waiting for an external control signal as soon as the analog output start command is output. Sampling when the specified edge (rising edge or falling edge) is input from the external control signal.

Sampling Stop Condition

The condition for controlling the stop of sampling can be selected from both the last setting count, and an external trigger. The board stops sampling whenever an error occurs irrespective of the stop condition setting.

Last setting count

When the memory type is FIFO, the board stops sampling the moment the sample count reaches the specified value.

For RING memory, specify the sampling count equivalent to one period of an arbitrary waveform.

- External trigger
 - The board starts waiting for an external control signal after the sampling has been started. Sampling stops when the specified edge (rising edge or falling edge) is input from the external control signal.

Repeat

You can specify a repeat count to perform sampling for a specified number of times.

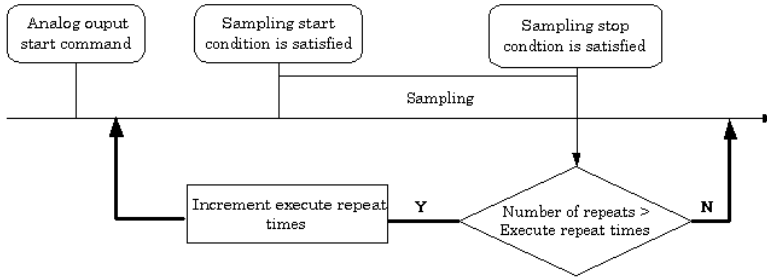

Memory must be set to ring format if a number of repetitions is to be specified.

(The number of repetitions cannot be specified for FIFO memory format.)

The number of repetitions is set by software and sampling is repeated for the specified number of times.

You can also specify that operation continue indefinitely. If set to repeat indefinitely, analog output operation is stopped by outputting an analog output stop command by software.

Event

"Event" works as a function for reporting the occurrence of a certain board state to the application.

The following events can be used in combination depending on the specifications and purpose of the application.

- "Sampling start condition satisfied" event
This event occurs when the sampling start condition is satisfied. The event is nullified when the sampling conversion start condition is "software".
- "Sampling stop condition satisfied" event
This event occurs whenever the sampling stop condition is met if the number of repetitions has been set.
- "End of device operation" event
This event occurs when the analog output operation is terminated.
- "Specified number of output samples complete" event
This event occurs when DA conversion is executed for the specified number of times. When the memory type is FIFO, the event occurs only once during sampling. When the memory type is RING, the event occurs as many times as the number of repetitions.
- Sampling clock error event
This event occurs when conversion stops as an error occurs due to a sampling clock period that is too short.
- DA conversion error event
This event occurs when the analog output operation stops upon detection of a device malfunction by the driver.

Starting/Stopping Operation

Analog output operation is started by a software command (the analog output start command).

Similarly, you can stop analog output at any time using a software command (the analog output stop command).

Monitoring the Status

You can use a software command to check the status of analog output operation and of the output data stored in memory.

Status

The current state of the device can be checked by obtaining the device status.

The following types of device status are available:

- Analog output operating
This status remains ON, after the board performs the analog output start command until the analog output operation is stopped.
- Waiting for start trigger
This status remains ON, after the board performs the analog output start command until the sampling start condition is satisfied, if the sampling start condition is an external trigger. The status is set to OFF when the external trigger is input to start sampling.
This status is set to ON whenever the board enters the conversion start wait status even when repeated operation has been set.
- Specified number of data items already output
- Sampling clock error
This error occurs when the analog output operation stops as the sampling clock cycle is too short.
- DA conversion error
This status is turned on when the analog output operation stops upon detection of a device malfunction by the driver.

Sampling count

The number of sampled items of output data transferred from in memory can be obtained by the software command.

Repeat

The current repeat count can be obtained by the software command.

Reset

Various states can be reset by executing the following reset commands:

All reset

This command resets the entire device, thereby initializing the device.

Status

This command resets the sampling clock error status and AD conversion error status.

Memory

This command resets the following memory related states.

- Resets the conversion data in memory.
- Resets the output sampling count.
- Resets the repeat count to 0.
- Resets the status information for the specified data save count.

5. About Software

CD-ROM Directory Structure

\	
— Autorun.exe	Installer Main Window
Readmej.html	Version information on each driver (Japanese)
Readmeu.html	Version information on each driver (English)
.	
— APIPAC	Each installer
— AIO	
— DISK1	
— DISK2	
—	
— DISKN	
— AioWdm	
— CNT	
— DIO	
—	
.	
— HELP	HELP file
— Aio	
— Cnt	
—	
.	
— INF	Each INF file for OS
— WDM	
— Win2000	
— Win95	
.	
— linux	Linux driver file
— cnt	
— dio	
—	
.	
— Readme	Readme file for each driver
.	
.	
— Release	Driver file on each API-TOOL (For creation of a user-specific install program)
— API_NT	
— API_W95	
.	
.	
— UsersGuide	Hardware User's Guide(PDF files)

About Software for Windows

The bundled CD-ROM “Driver library API-PAC(W32)” contains the functions that provide the following features:

- Analog input or output through arbitrary channels
- Analog input at arbitrary intervals using the internal or external sampling clock
- Simultaneous monitoring of the termination of analog input sampling, buffer memory usage, and interrupt events such as occurrences of errors
- Driver option check using a demo driver even without the board installed

For details, refer to the help file. The help file provides various items of information such as “Function Reference”, “Sample Programs” and “Q&A”. Use them for program development and troubleshooting.

When using the API-AIO(WDM)

Accessing the Help File

- (1) Click on the [Start] button on the Windows taskbar.
- (2) From the Start Menu, select “Programs” – “CONTEC API-PAC(W32)” – “AIOWDM” – “API-AIO(WDM) HELP” to display help information.

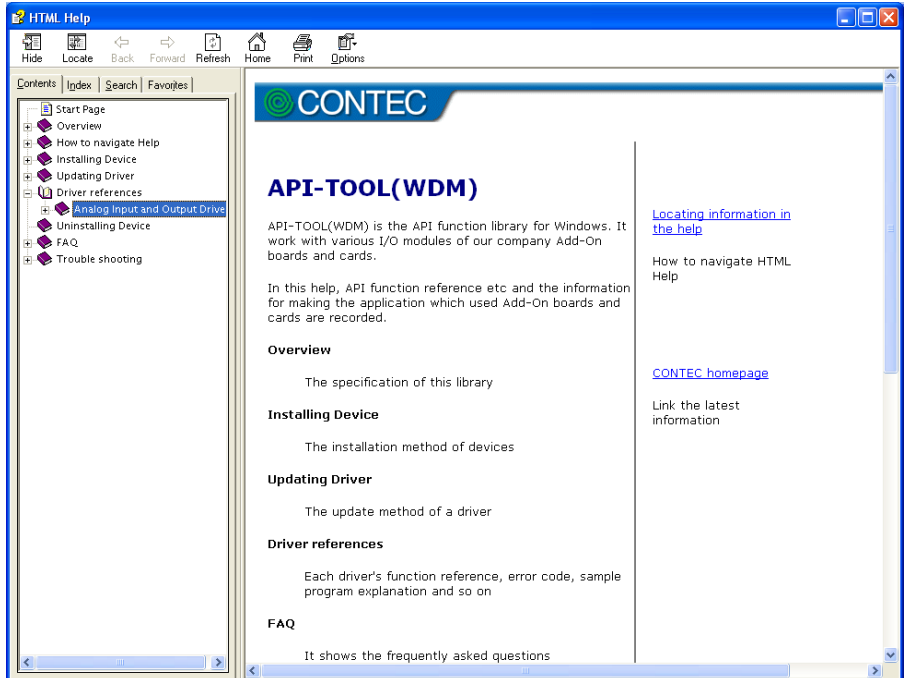

Using Sample Programs

Sample programs are provided for each of the basic operations. You can use these to check the operation of the board and as a reference when writing your own programs.

To use the sample programs, specify the device name in the property page for the program.

The sample programs are stored in `\Program Files\CONTEC\API-PAC(W32)\AIOWDM\Samples`.

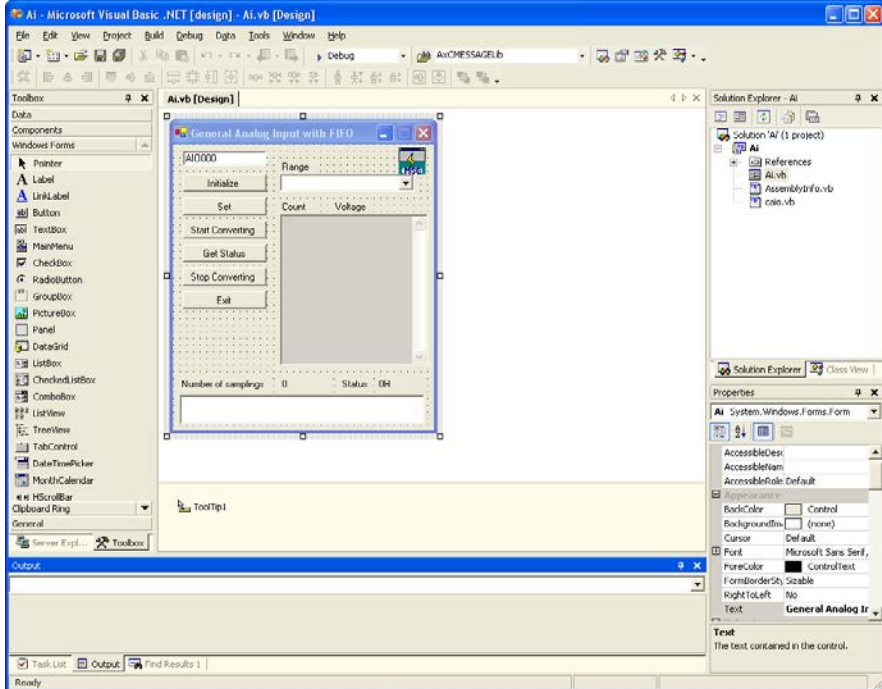

Running a Sample Program

- (1) Click on the [Start] button on the Windows taskbar.
- (2) From the Start Menu, select “Programs” – “CONTEC API-PAC(W32)” – “AIOWDM” – “SAMPLE...”.
- (3) A sample program is invoked.

Sample Programs - Examples

Analog input

- SingleAi Perform single analog input from specified channel
- MultiAi Perform single analog input from multiple channels
- Ai Perform standard analog input using a FIFO buffer
- AiPoll Perform standard analog input by polling
- AiEx Perform analog input for multiple channels using a FIFO buffer
- AiLong Perform long-duration analog input using a FIFO buffer
- AiExt Perform analog input using an external clock
- AiTrg Perform analog input using an external trigger to start and stop operation
- AiLevel1 Use a level trigger to start analog input
- AiLevel2 Use a level trigger to stop analog input
- Ai2 Perform standard analog input using more than one board

Analog output

- SingleAo Perform single analog output from specified channel
- MultiAo Perform single analog output from multiple channels
- Ao Perform standard analog output using a FIFO buffer
- AoPoll Perform standard analog output by polling
- AoEx Perform analog output for multiple channels using a FIFO buffer
- AoLong Perform long-duration analog output using a FIFO buffer
- AoExt Perform analog output using an external clock
- AoRing Perform continuous analog output using a ring buffer
- AoTrg Perform analog output using an external trigger to start and stop operation
- Ao2 Perform standard analog output using more than one board

Digital input/output

- DioBit Perform digital I/O using bit values
- DioByte Perform digital I/O using port values

* Sample programs executable vary with the functions of boards in use.

Usage of Utility Program

Program for Measurement of Function Execution Speed

The execution time of some main functions can be measured in a function execution speed measurement program. To use a function execution speed measurement program, click the [execution time measurement] button in the diagnostic program.

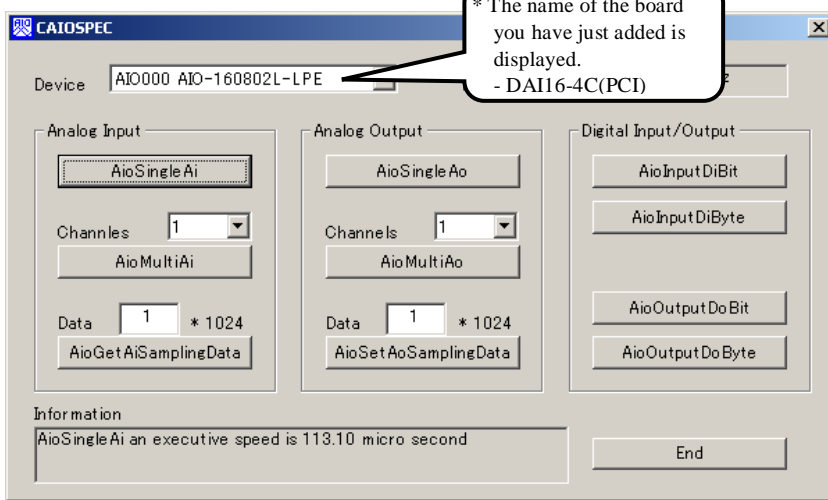

⚠ CAUTION

Even if this product is installed, the displayed board name is “DAI16-4C(PCI)”.
There is no problem in operation even if the board name is displayed as “DAI16-4C(PCI)”.

Procedure

- (1) Chose the measure device from device list.
- (2) Click the button written with the function name to measure the execution speed of the function.
Please choose from a list the number of channels used for conversion in function AioMultiAi and AioMultiAo. Input the transmission data size in function AioGetAiSamplingData and AioSetAoSamplingData. The transmission data is set by unit of kByte.
- (3) End the application with an [end] button.

Analog Output Measurement Tool

It is an analog output measurement utility to carry out infinity sample in the FIFO memory. Once the conversion data of memory accumulates to a certain quantity, the event occurs and new output data is added. Data in the FIFO memory can be confirmed visually.

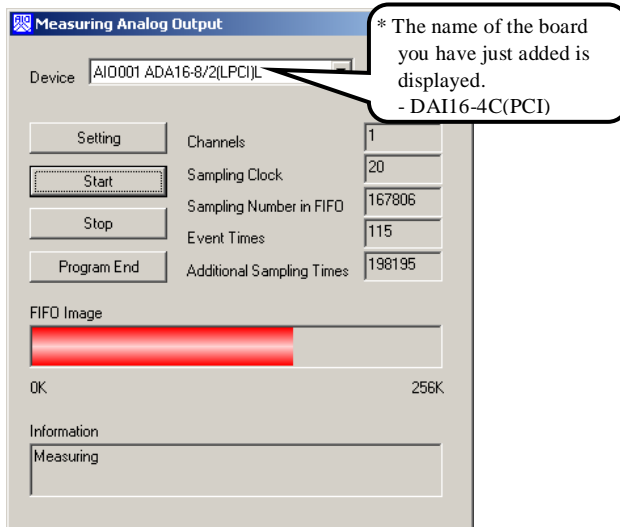

⚠ CAUTION

- Even if this product is installed, the displayed board name is "DAI16-4C(PCI)". There is no problem in operation even if the board name is displayed as "DAI16-4C(PCI)".
- **This program is made with Visual Basic. Therefore, it is not possible to execute it as it is in the environment in which Visual Basic is not installed. The program can be used by executing the following setup below the folder that installs the API-AIO(WDM).**

AIOWDM\Utility\AoSpec\setup.exe

Procedure

- (1) Chose the device name of the device to be used from the upper left combo box, and click the setting button.
- (2) The conversion conditions are set on the screen of the setting analog output.

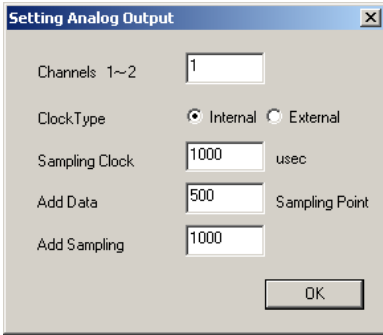

Once an output is done at the sampling frequency specified as data setting sampling frequency, an event occurs and data will be added. Click the OK button to finish setting the conditions, and returns to former screen.

- (3) Start the measurement with measurement start button. The various states during the conversion are displayed.

The number of the samplings in FIFO is :

It is conversion data set in the memory. This can be visually checked in a "memory image".

Event generation sampling frequency :

When the number of unoutput sampling in FIFO reaches this frequency, the event generates.

Adding sampling frequency :

It is the number of samplings of output data to be added during the event.

Measurement may stop by the following errors.

Sampling clock error :

It means that the conversion speed is too fast and the driver processing is not in time when converting at the internal clock.

The cycle of the clock is too fast when converting it at the external clock. Moreover, the cause by noise etc. is also concerned.

- (4) Click the "stop" button, and measurement stops.

When using the API-AIO(98/PC)

Accessing the Help File

- (1) Click on the [Start] button on the Windows taskbar.
- (2) From the Start Menu, select “Programs” – “CONTEC API-PAC(W32)” – “Aio” – “API-AIO HELP” to display help information.

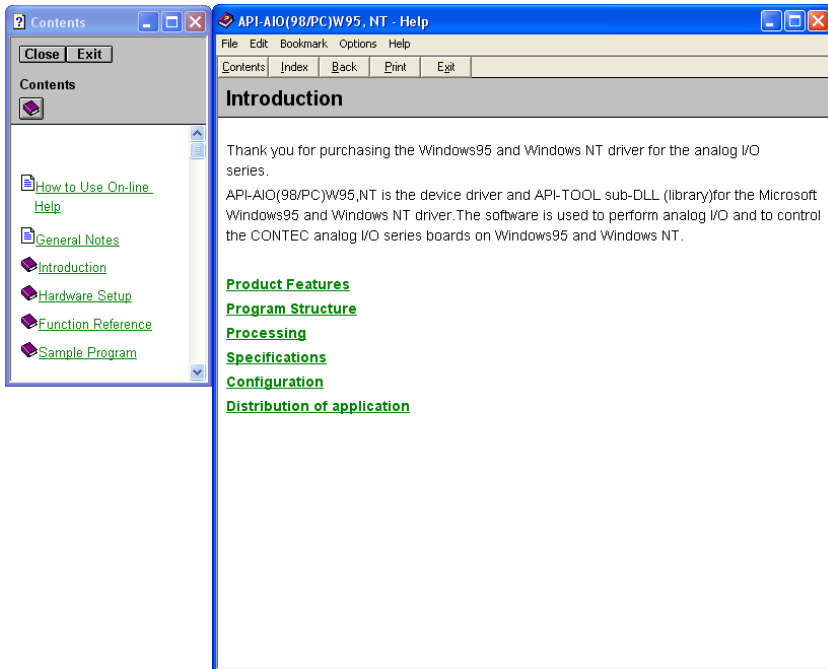

Using Sample Programs

Sample programs have been prepared for specific basic applications.

To use each sample program, enter its device name set by API-TOOL Configuration.

Use these sample programs as references for program development and operation check.

The sample programs are stored in \Program Files\CONTEC\API-PAC(W32)\Aio\Samples.

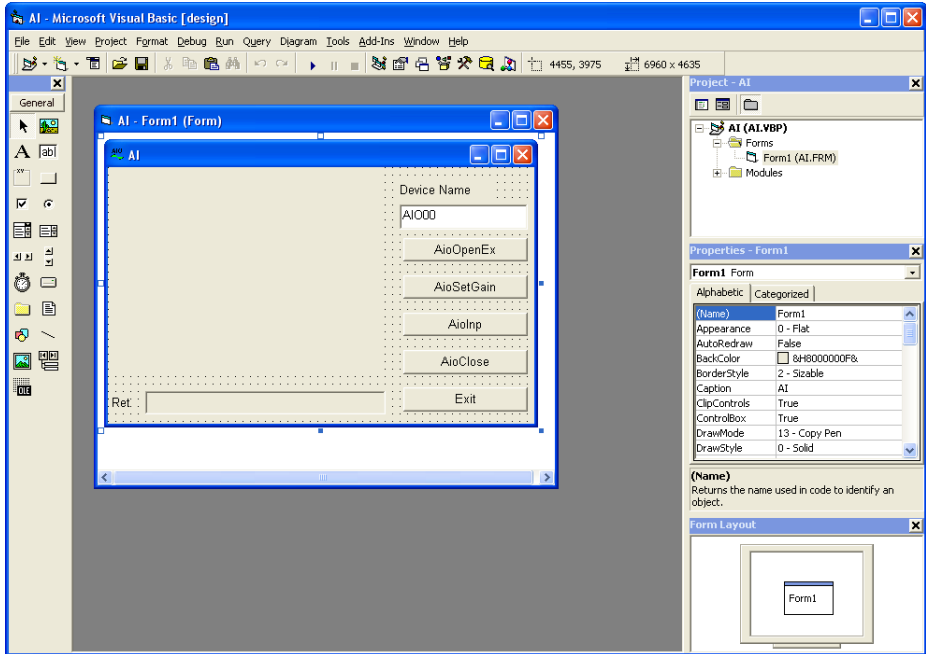

Running a Sample Program

- (1) Click on the [Start] button on the Windows taskbar.
- (2) From the Start Menu, select “Programs” – “CONTEC API-PAC(W32)” – “Aio” – “SAMPLE...”.
- (3) A sample program is invoked.

Sample Programs - Examples

Analog input

- AI : Uses AioInp to convert an analog signal only once and display the data.
- AIBack : Uses AioInpBack to perform memory-less board analog input.
- AIMemory : Uses AioInpBdMem to perform continuous conversion and AioReadBuf to acquire data from board memory (an example of using an external clock).
- AIInt : Infinite sampling example that uses AioInpBdMem for half/full interrupts and AioReadBuf to acquire data at interrupt events.
- AITimer : Infinite sampling example that uses AioInpBdMem to perform continuous conversion and AioReadBuf to acquire data at system timer events.
- AISync : Sample that uses AioInpBdMem and AioDO to perform simultaneous sampling of two memory-mounted boards.
- AioInp : Sample console application that uses AioOpenEx and AioInp.

Analog output

- AO : Uses AioOut to perform analog output once.
- AOBBack : Uses AioOutBack to perform analog output at fixed intervals.
- AioOut : Sample console application that uses AioOpenEx and AioOut.

Digital input and output

- DIO : Uses AioDO and AioDI to perform digital input/output.

Counter

- Timer : Sample program using a timer. It uses the counter function to measure the lapse of time.
- Counter : Sample program using a counter. It uses the counter function to count external pulses.

The following sample program in Visual Basic is available.

- ANALOG : Versatile sample program using AioInp, AioInpBack, AioInpBdMem, AioOut, AioOutBack, AioDO, and AioDI.

* Sample programs executable vary with the functions of boards in use.

Using the Utility Program

Operation Check Tool

This program is a comprehensive operation check tool that can use all the features of the AioOpen, AioClose, AioSetRangeAioInp, AioInpBack, AioInpBdMem, AioOut, AioOutBack, AioDo, and AioDi functions.

Invoke the tool by selecting the Start Menu – “CONTEC API-PAC(W32)” – “AIO” – “SAMPLE Analog”.

[Main screen]

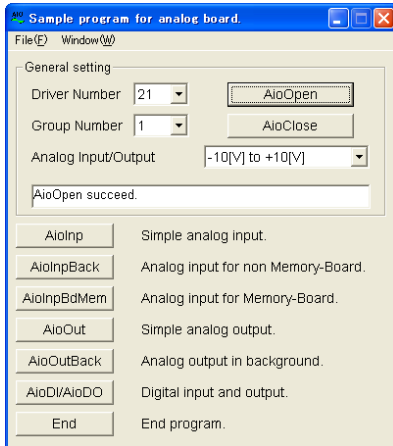

- AioInp : Simple analog input
- AioInpBack : Analog input for non Memory-Board
- AioInpBdMem: Analog input for Memory-Board
- AioOut : Simple analog output
- AioOutBack : Analog output in background
- AioDi/AioDo : Digital input and output

[Analog input]

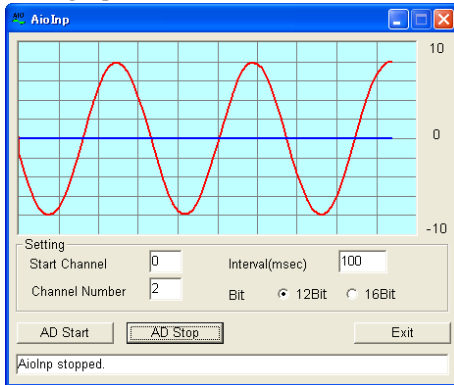

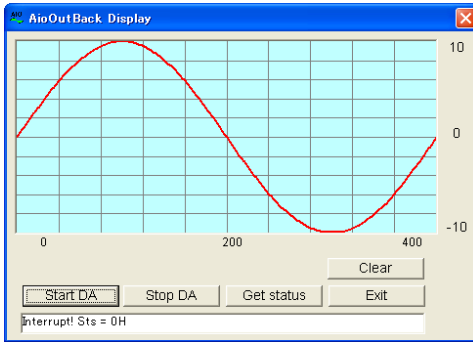
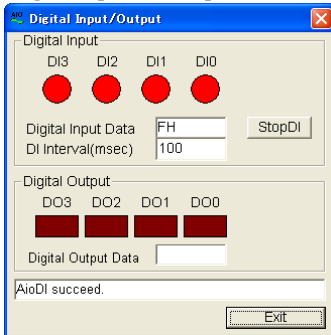
[Analog output]**[Digital input and output]**

Uninstalling the Driver Libraries

To uninstall API-PAC(W32), follow the procedure below.

- (1) Click on the [Start] button on the Windows taskbar. From the Start Menu, select “Settings” – “Control Panel”.
- (2) Double-click on “Add/Remove Programs” in the Control Panel.
- (3) If the API-AIO(WDM), select “CONTEC API-AIO(WDM) driver” and “CONTEC API-AIO(WDM) VerX.XX (Development)” from the displayed application.
If the API-AIO(98/PC), select “CONTEC API-AIO(98/PC)xx VerX.XX (Development) and “CONTEC API-AIO(98/PC)xx VerX.XX (Runtime)”
Click on the [Change/Remove] button. Follow the on-screen instructions to uninstall the function libraries.

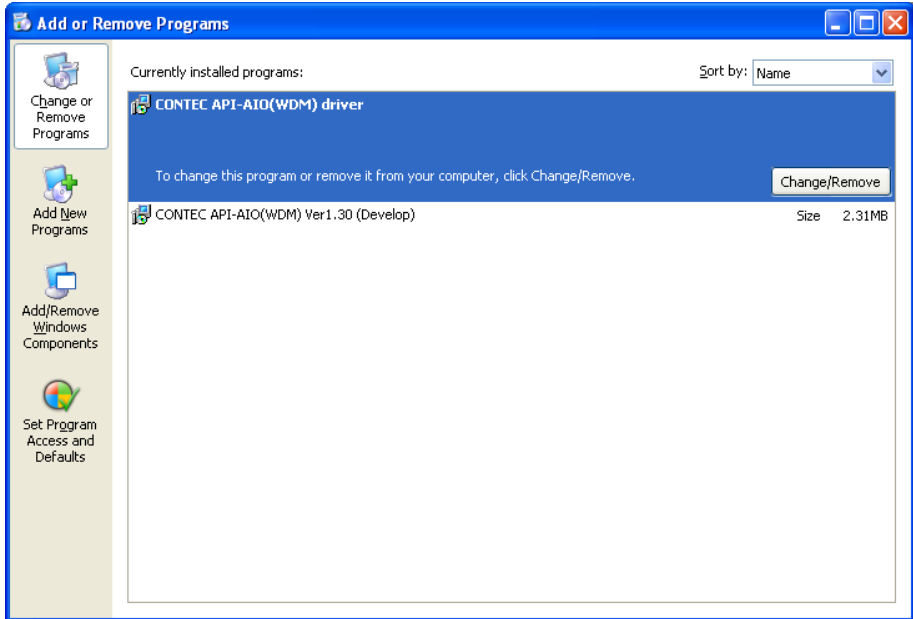

About Software for Linux

The Linux version of analog I/O function driver, API-AIO(LNX), provides functions that execute the following features:

- The analog input/output of a specified channel can be done.
- It is possible to operate as a set parameter to the analog input/output board is preserved by the default value, and the setting of the parameter doesn't exist.

For details, refer to the help file. The help file provides various items of information such as "Function Reference", "Sample Programs", and "FAQs". Use them for program development and troubleshooting.

Driver Software Install Procedure

The Linux version for digital I/O driver, API-AIO(LNX), is supplied as a compressed file /linux/aio/caioXXX.tgz on the bundled API-PAC(W32)CD-ROM. (Note: XXX represents the driver version.)

Mount the CD-ROM as shown below, copy the file to an arbitrary directory, and decompress the file to install the driver.

For details on using the driver, refer to readme.txt and the help file in HTML format extracted by installation.

To install the driver, log in as a superuser.

Decompression and setup procedure

```
# cd
# mount /dev/cdrom /mnt/cdrom           Mount the CD-ROM.
# cp /mnt/cdrom/linux/aio/caioXXX.tgz ./ Copy the compressed file.
# tar xvfz caioXXX.tgz                 Decompress the compressed file.
.....
# cd contec/caio
# make
                                     Compile the file.
.....
# make install                         Install.
.....
# cd config
# ./config                             Set up the board to be used.
..... Set as follows.....
# ./contec_aio_start.sh                Start the driver.
# cd
```

Accessing the Help File

- (1) Invoke a web browser in your X-Window environment.
- (2) In the browser, open diohelp.htm in the contec/caio/help directory.

Using Sample Programs

Sample programs have been prepared for specific basic applications.

Sample programs for each language are contained in the contec/caio/samples directory. For compiling them, refer to the manual for the desired language.

Uninstalling the driver

To uninstall the driver, use the uninstall shell script contained in the contec/caio directory. For details, check the contents of the script.

6. About Hardware

This chapter provides hardware specifications and hardware-related supplementary information.

For detailed technical information

For further detailed technical information (“Technical Reference” including the information such as an I/O map, configuration register, etc.), visit the Contec's web site (<http://www.contec.com/support/>) to call for it.

Hardware specification

Table 6.1. Specification

Item	Specification
Analog Output	
Isolated specification	Isolated independently
Number of output channels	4ch
Output range	Bipolar $\pm 10\text{V}$, Unipolar $0 \sim +10\text{V}$ $0 \sim 20\text{mA}$ (Jumper setting by channel)
Absolute max. output current	$\pm 5\text{mA}$ (Voltage output) $\pm 10\text{V}$, $0 \sim +10\text{V}$
Load register (Max.)	500Ω (Current output)
Output impedance	10Ω or less (Voltage output)
Resolution	16bit
Non-Linearity error *1	$\pm 5\text{LSB}$ ($\pm 10\text{V}$, $0 \sim +10\text{V}$), $\pm 15\text{LSB}$ ($0 \sim 20\text{mA}$)
Conversion speed	$20\mu\text{sec}$ (Max.)
Voltage output control relay	AQY221N2SX (Matsushita Electric Works, Ltd.) or equivalent to it
Sampling clock	Internal sampling clock : $20,000 \sim 1,073,741,824,000\text{nsec}$ (Can be set in 250n sec units) External sampling clock : opto-coupler isolated input (corresponding to current sink output)
Programmable timer	
Setting frequency	$500 \sim 1,073,741,824,000\text{nsec}$ (Can be set in 250n sec units)
Timer output signal	Opto-coupler isolated open collector output (current sink type)
External trigger input	
External trigger input signal	Opto-coupler isolated input (corresponding to sink output)
Status	Trigger input, trigger input overrun
I/O address	32 ports boundary
Interrupt level	1 point
Isolation voltage	500Vrms
Power consumption	$+5\text{VDC}$ 2400mA (Max.)
Operating condition	$0 \sim 50^\circ\text{C}$, $10 \sim 90\%\text{RH}$ (No condensation)
Bus specification	PCI (32bit, 33MHz, Universal key shapes supported *2)
External dimensions (mm)	$176.41(\text{L}) \times 105.68(\text{H})$
Used connector	37-pin D-SUB connector [F(Male) type] DCLC-J37SAF-20L9E [mfd.by JAE] equivalent to it
Weight	160g

*1 When the environment temperature is near 0°C or 50°C , the non-linearity error may become larger.

The error can be reduced by calibrating under the actual temperature conditions.

*2 The board requires $+5\text{V}$ power supply from the expansion slot (it does not work in a $+3.3\text{V}$ environment).

Board dimension

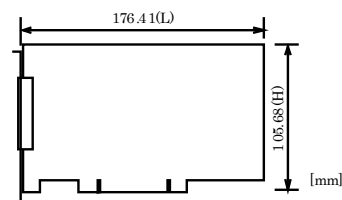

The standard outside dimension (L) is the distance from the end of the board to the outer surface of the slot cover.

Block Diagram

Figure 6.1 is a circuit block diagram of this board.

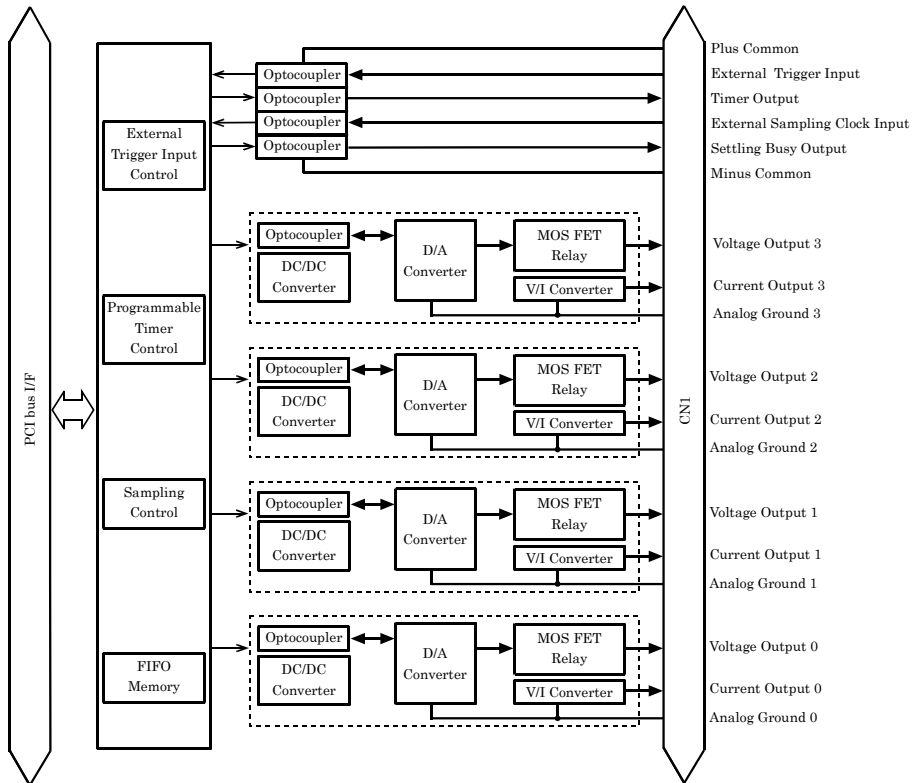

Figure 6.1. Block Diagram

Timing of Sampling Control Signals

Signal spec of external sampling clock, external trigger input

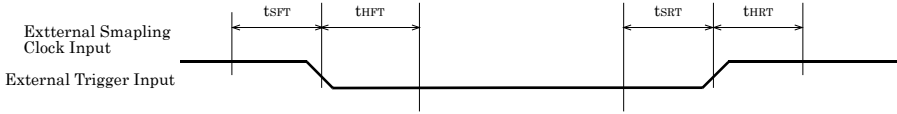

Figure 6.2. Signal spec of external sampling clock, external trigger input

Table 6.2. Details on each part

Parameter	Symbol	Min.
Input circuit OFF→Setup time of ON	t_{sFT}	2.5 μ sec
Input circuit OFF→Hold time of ON	t_{HFT}	2.5 μ sec
Input circuit ON→Setup time of OFF	t_{sRT}	2.5 μ sec
Input circuit ON→Hold time of OFF	t_{HRT}	2.5 μ sec

Timing of external trigger input and input status

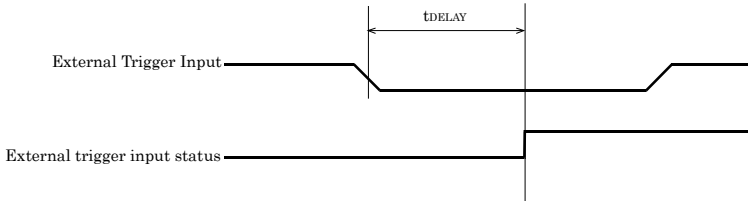

Figure 6.3. Timing of external trigger input and input status

Table 6.3. Details on each part

	Symbol	Min.
Delay time	t_{DELAY}	5 μ sec

Timing of external sampling clock and “Settling Busy Output”

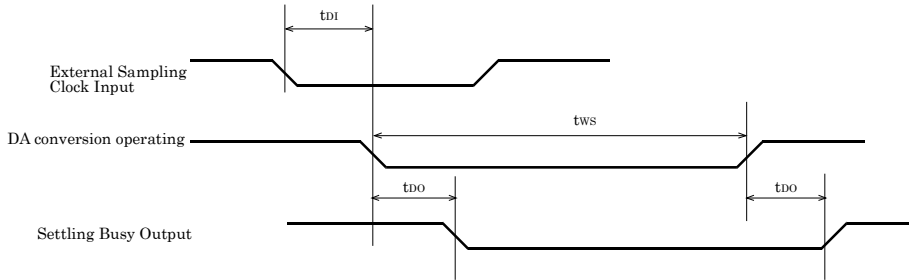

Figure 6.4. Timing of external sampling clock and “Settling Busy Output”

Table 6.4. Details on each part

	Symbol	Min.	Max.
Input delay time	t_{DI}	5 μ sec	---
Settling time	t_{WS}	---	20 μ sec
Output delay time	t_{DO}	2.5 μ sec	---

Timing of “Timer Output”

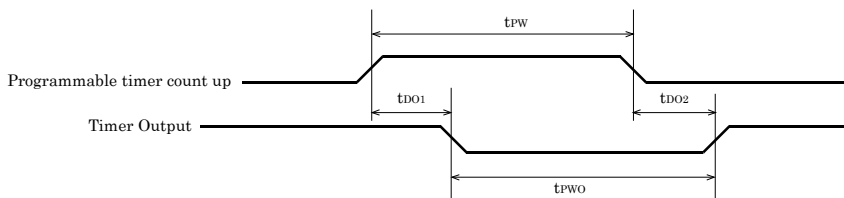

Figure 6.5. Timing of “Timer Output”

Table 6.5. Details on each part

	Symbol	Min.	Average	Reference value
Pulse width when Count up occurs	t_{PW}	---	2.5 μ sec	---
Output delay time 1	t_{DO1}	2.5 μ sec	---	---
Output delay time 2	t_{DO2}	2.5 μ sec	---	---
Output pulse width	t_{PWO}	---	---	3 μ sec *

* External power supply : 24V, Loading : 25°C when connecting the 510 Ω

About Calibration

This board is calibrated before shipment.

Contact your retailer if the board does not provide its prescribed performance.

Difference from AO-1604CI2-PCI and DAI16-4C(PCI)

This product is a successor of the previous model AO-1604CI2-PCI and DAI16-4C(PCI).

So you can use the same operating procedures as AO-1604CI2-PCI and DAI16-4C(PCI).

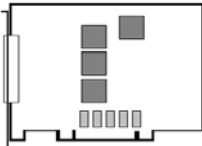
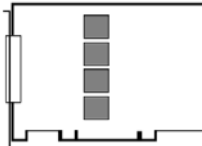
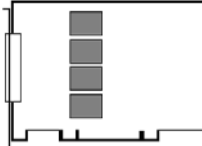
	AO-1604CI3-PCI	AO-1604CI2-PCI	DAI16-4C(PCD)
About the display of the mounted board name	DAI16-4C(PCI) *1	DAI16-4C(PCI) *1	DAI16-4C(PCD)
Environmental support	Product for RoHS instruction	Product for RoHS instruction	Lead decrease product
Appearance			
External dimensions (mm)	176.41(L)×105.68(H)	176.41(L)×106.68(H)	176.41(L)×106.68(H)

*1: Even if this product is installed, the displayed board name is "DAI16-4C(PCD)".

There is no problem in operation even if the board name is displayed as "DAI16-4C(PCD)".

AO-1604CI3-PCI

User's Guide

CONTEC CO., LTD.

December 2017 Edition

3-9-31, Himesato, Nishiyodogawa-ku, Osaka 555-0025, Japan
<https://www.contec.com/>

No part of this document may be copied or reproduced in any form by any means without prior written consent of CONTEC CO., LTD. [12252017]

[02032014]

Management No. NA03044

[12252017_rev2]

Parts No. LYRA502