



MVP-6010 Series

MVP-6020 Series

6th Generation Intel® Core™ i7/i5/i3
Fanless Computer

MVP-6011/MVP-6012/MVP-6013/MVP-6015

MVP-6021/MVP-6022/MVP-6023/MVP-6025

User's Manual



Manual Rev.: 1.0

Revision Date: June 23, 2017

Part No: 50-1Z214-1000

Leading **EDGE COMPUTING**

Revision History

Revision	Release Date	Description of Change(s)
1.0	June 23, 2017	Initial Release

Preface

Copyright 2017 ADLINK Technology, Inc.

This document contains proprietary information protected by copyright. All rights are reserved. No part of this manual may be reproduced by any mechanical, electronic, or other means in any form without prior written permission of the manufacturer.

Disclaimer

The information in this document is subject to change without prior notice in order to improve reliability, design, and function and does not represent a commitment on the part of the manufacturer.

In no event will the manufacturer be liable for direct, indirect, special, incidental, or consequential damages arising out of the use or inability to use the product or documentation, even if advised of the possibility of such damages.

Environmental Responsibility

ADLINK is committed to fulfill its social responsibility to global environmental preservation through compliance with the European Union's Restriction of Hazardous Substances (RoHS) directive and Waste Electrical and Electronic Equipment (WEEE) directive. Environmental protection is a top priority for ADLINK. We have enforced measures to ensure that our products, manufacturing processes, components, and raw materials have as little impact on the environment as possible. When products are at their end of life, our customers are encouraged to dispose of them in accordance with the product disposal and/or recovery programs prescribed by their nation or company.

Trademarks

Product names mentioned herein are used for identification purposes only and may be trademarks and/or registered trademarks of their respective companies.

Conventions

Take note of the following conventions used throughout this manual to make sure that users perform certain tasks and instructions properly.



NOTE:

Additional information, aids, and tips that help users perform tasks.



CAUTION:

Information to prevent **minor** physical injury, component damage, data loss, and/or program corruption when trying to complete a task.



WARNING:

Information to prevent **serious** physical injury, component damage, data loss, and/or program corruption when trying to complete a specific task.

Table of Contents

Preface	iv
List of Tables	xii
List of Figures	xiv
1 Introduction	1
1.1 Overview	1
1.2 Features	1
1.3 Specifications	2
1.3.1 MVP-6011/6021, MVP-6012/6022, MVP-6013/6023 ..	2
1.3.2 MVP-6015/6025	4
1.3.3 Power Consumption	5
1.4 Schematics and Dimensions	8
1.5 Front Panel I/O Connectors	11
1.5.1 Power Button	12
1.5.2 LED Indicators	13
1.5.3 PCI Slot	13
1.5.4 PCI Express x16 Slot	13
1.5.5 Reset Button	13
1.5.6 DisplayPort Connectors	14
Display Options	15
1.5.7 Digital I/O Connector	15
8-channel Digital Input	15
8-channel Digital Output	15
1.5.8 DVI-D Connector	18
1.5.9 VGA Connector	18
1.5.10 USB 2.0 Ports	19
1.5.11 Gigabit Ethernet Ports	19
1.5.12 USB 3.0 Ports	21
1.5.13 DC Power Connector	21

1.5.14	COM Port Connectors	22
1.6	Rear-Mounted CFast Host Connector	23
1.7	Internal I/O Connectors.....	24
1.7.1	MVP-6010 Series Backplane Connectors	25
1.7.2	MVP-6020 Series Backplane Connectors	26
1.7.3	GPS Module Power Headers.....	27
1.7.4	USB 2.0 Connector.....	27
1.7.5	Mini-PCIe Connector	27
1.7.6	SATA Connector.....	27
1.7.7	9V Fan Connector.....	28
1.7.8	Clear CMOS Jumper	28
1.7.9	Extended PWR/RESET header	29
1.7.10	USIM Slot.....	29
1.7.11	Internal Reserved +5V and +12V Connector.....	29
1.7.12	Backboard to System PCB Connector.....	30
1.7.13	12V DC Fan Connector	30
2	Getting Started.....	33
2.1	Unpacking Checklist	33
2.2	Deployment.....	34
2.3	Installing Hard Disk Drives.....	36
2.4	Installing a PCI/PCIe Card	39
2.5	Installing CFast Cards.....	40
2.6	Wall-mounting the MVP-6010/MVP-6020	41
2.6.1	Underside Wall-mounting	42
2.6.2	Left Side Wall-mounting.....	45
2.7	Driver Installation	48
A	Appendix: Power Consumption	49
A.1	Power Consumption Reference	49
A.2	Power Supply Reference	50
A.3	Accessory Cabling	50

B Appendix: BIOS Setup	51
B.1 Main	51
BIOS Information	52
Platform Information	52
FW Information	52
System Time/System Date	53
B.2 Advanced	53
B.2.1 CPU Configuration	54
Hyper-Threading	55
Active Processor Cores	55
Intel Virtualization Technology	55
CPU AES	55
Intel(R) SpeedStep(tm)	55
CPU C States	55
Intel TXT(LT) Support	55
TCC Activation Offset	55
B.2.2 Memory Configuration	56
B.2.3 System Agent (SA) Configuration	57
VT-d	57
B.2.4 Graphics Configuration	58
Primary Display	58
GTT Size	58
Aperture Size	58
DVMT Pre-Allocated	58
DVMT Total Gfx Mem	59
B.2.5 Onboard Device Configuration	59
Serial Port 1 to 4 Configuration	59
LAN #1 (Intel I211AT)	59
LAN #1(I211AT) Launch PXE OpROM	59
LAN #2 (Intel I211AT)	60
LAN #2(I211AT) Launch PXE OpROM	60
LAN #3 (Intel I211AT)	60

	LAN #3(I211AT) Launch PXE OpROM	60
	Serial Port Console Redirection	60
B.2.6	Advanced Power Management.....	61
	State After G3	61
	State After G3	62
	RTC Wake system from S5	62
	BIOS POST Watchdog	62
B.2.7	USB Configuration	63
	Legacy USB Support	63
	XHCI Hand-off	63
	USB Mass Storage Driver Support	63
	Port 60/64 Emulation	63
	USB transfer time-out	64
	Device reset time-out	64
	Device power-up delay	64
B.2.8	SATA Configuration.....	64
	SATA Port and CFAST Card	64
B.2.9	CSM Configuration	65
	CSM Support	65
	GateA20 Active	65
	Option ROM Messages	65
	Boot option filter	65
	Network	66
	Storage	66
	Video	66
	Other PCI devices	66
B.3	Security.....	66
	Administrator Password	67
	User Password	67
	RTC Lock	67
	BIOS Lock	67
B.4	Boot	68

Setup Prompt Timeout	68
Bootup Num-Lock State	68
Quiet Boot	69
Fast Boot	69
Boot Option Priorities	69
B.5 Save & Exit	71
Discard Changes and Exit	71
Save Changes and Reset	71
Discard Changes	71
Restore Defaults	71
Save as User Defaults	72
Restore User Defaults	72
Launch EFI Shell from filesystem device	72
C Appendix: Watchdog Timer (WDT)	
Function Library.....	73
C.1 WDT with API/Windows.....	73
InitWDT	73
SetWDT	73
C.2 WDT with DOS/Linux.....	76
D Appendix: Digital Input/Output	
Function Library.....	79
DI/O with API/Windows	79
Important Safety Instructions	81
Getting Service.....	85

This page intentionally left blank.

List of Tables

Table 1-1:	MVP-6010 Series Front Panel I/O Connector Legend	12
Table 1-2:	MVP-6020 Series Front Panel I/O Connector Legend	12
Table 1-3:	LED Indicators	13
Table 1-4:	DisplayPort Pin Assignments	14
Table 1-5:	Applicable Cable Types	14
Table 1-6:	Maximum Available Resolutions with 2-Display Configuration	15
Table 1-7:	Digital Input Connector Pin Legend	16
Table 1-8:	Digital Output Connector Pin Legend	17
Table 1-9:	DVI-D Connector Pin Legend	18
Table 1-10:	VGA Connector Pin Legend	19
Table 1-11:	Active/Link LED Indicators.....	21
Table 1-12:	Speed LED Indicators.....	21
Table 1-13:	DC Power Supply Connector Signals.....	22
Table 1-14:	D-Sub 9p Signal Function of COM Ports	23
Table 1-15:	Mainboard Connector Legend	24
Table 1-16:	MVP-6010 Series Backplane Board Connector Legend	25
Table 1-17:	MVP-6020 Series Backplane Board Connector Legend	26
Table A-1:	Power Consumption	49
Table A-2:	Power Supply	50

This page intentionally left blank.

List of Figures

Figure 1-1: MVP-6010 Series Functional Block Diagram.....	6
Figure 1-2: MVP-6020 Series Functional Block Diagram.....	7
Figure 1-3: Front View.....	8
Figure 1-4: Left Side View.....	9
Figure 1-5: Top View.....	9
Figure 1-6: Rear View.....	10
Figure 1-7: Underside View.....	10
Figure 1-8: Front Panel I/O Connectors.....	11
Figure 1-9: DisplayPort Connector.....	14
Figure 1-10: Digital I/O Connector Pin Assignment.....	16
Figure 1-11: Digital Input Circuit.....	17
Figure 1-12: Digital Output Circuit.....	17
Figure 1-13: DVI-D Connector Pin Assignment.....	18
Figure 1-14: VGA Connector Pin Assignment.....	18
Figure 1-15: Ethernet Port and LED Legend.....	20
Figure 1-16: DC Power Connector.....	22
Figure 1-17: COM Port.....	22
Figure 1-18: CFast Host Connector (on rear panel).....	23
Figure 1-19: Mainboard I/O Connectors.....	24
Figure 1-20: MVP-6010 Series Backplane Board PCB.....	25
Figure 1-21: MVP-6020 Series Backplane Board PCB.....	26
Figure 1-22: Clear CMOS Jumper Setting.....	28
Figure 2-1: Upright Deployment.....	34
Figure 2-2: Left Side Deployment.....	35

This page intentionally left blank.

1 Introduction

1.1 Overview

ADLINK's MVP-6010/MVP-6020 Series of value line fanless embedded computing platforms, incorporating the 6th Generation Intel® Core™ processor, provides one PCIe16 and three PCI or two PCIe16 and two PCI expansion slots, one mini-PCIe slot and single-side access for I/O ports, optimizing easy maintenance in industrial automation environments. The series retains the robust design of all ADLINK MXC/MXE lines, at a new extremely cost-effective price point. The MVP-6010/MVP-6020 series supports DDR4 memory for more powerful computing and the Intel® HD Graphics 530 speeds graphics performance. Along with a versatile I/O array and flexible expansion capacity, the MVP-6010/MVP-6020 Series fully satisfies all the needs of industrial automation with the performance demanded by vision inspection, motion control, and surveillance applications. Fanless construction not only overcomes contaminant and noise challenges presented by harsh IA environments, the elimination of problematic structural elements that negatively affect MTBF greatly increases lifecycle expectations for the platform.

1.2 Features

- ▶ 6th Generation Intel® Core™ i7/i5/i3 Skylake FCLGA1151 processor + H110 (MVP-6010)/Q170 (MVP-6020) chipset
- ▶ 2 x DDR4 SO-DIMM socket, supporting up to 32GB DDR4 2133 SO-DIMM module
- ▶ 1 PCIe16 and 3 PCI (MVP-6010)/ 2 PCIe16 and 2 PCI (MVP-6020) expansion slots available, supporting Gen3 PCIe cards
- ▶ Supports 2 independent displays with on-board 2x Display-Port, 1x DVI-D, and 1x VGA ports onboard
- ▶ 6 External USB ports (4x USB 3.0, 2x USB 2.0), 1 internal USB 2.0 port
- ▶ 3 Intel GbE LAN ports with teaming function
- ▶ Built-in 8CH DI and 8CH DO, 2 software-programmable RS-232/422/485 + 2 RS-232 ports

- ▶ CFast socket, onboard SATA III port for 1x 2.5" HDD/SSD installation, and SATA 6Gb/s
- ▶ Built-in wide-range 12V DC to 24V DC power input
- ▶ Fanless operation from 0°C to 50°C (with 35W CPU), and 0°C to 40°C (with 65W CPU)



NOTE:

This option guarantees cold boot of the system at 0°C and operation with 100% loading at 50° without add-on cards. The industrial solid-state drive storage option is required.

1.3 Specifications

1.3.1 MVP-6011/6021, MVP-6012/6022, MVP-6013/6023

	MVP-6011/6021	MVP-6012/6022	MVP-6013/6023
System Core			
Processor	Intel® Core™ i7-6700TE	Intel® Core™ i5-6500TE	Intel® Core™ i3-6100TE
Chipset	MVP-601x: H110 MVP-602x: Q170		
Video	1 VGA + 2 DisplayPort + 1 DVI-D		
Memory	4 GB DDR4 2133 MHz (up to 32 GB)		
OS	Win7 32/64-bit, Win 10 64-bit, Linux*		
I/O Interface			
Expansion slots	MVP-601x: 1 PCIe Gen3 x16 + 3 PCI (MVP-601x) MVP-602x: 2 PCIe Gen3 x16 (x16 slots with x8 signals) + 2 PCI		
Ethernet	3 Intel® GbE ports 3 Intel® I211AT WOL function on each port Teaming		
Serial ports	4 COM via DB9 connector 2 software-programmable RS-232/422/485 (COM1 & 2) [BIOS select] 2x RS-232 (COM3 & 4) RS-485 support for auto-flow control 2 KV surge protection on RS-422/485		

	MVP-6011/6021	MVP-6012/6022	MVP-6013/6023
USB	6 external USB ports (4x 3.0 + 2x 2.0) (each supporting 1.6A w/ 1 internal USB 2.0 port for 40 mil/A trace design and 5V ± 5% voltage stability)		
DI/O	8CH DI and 8CH DO		
Mini PCIe	1 internal mini PCIe		
USIM	1 USIM		
Audio	1 Mic-in and 1 Line out		
Power Supply			
DC Input	Built-in 12-24 VDC wide-range DC input 3P pluggable connector with latch (GND, V-, V+)		
AC Input	Optional 160 W external AC-DC adapter for AC input		
Storage Device			
SATA HDD	1 SATA port for 2.5" HDD/SSD (up to 6 Gb/s)		
CompactFlash	1 Type II CFast		
Mechanical			
Dimensions	220(W) X 210(D) X 208.7(H)mm (8.67" x 8.27" x 8.21")		
Weight	4.7 kg (10.36 lbs)		
Mounting	Wall mount kit		
Environmental			
Operating Temp.	0°C to 50°C		
Storage Temp.	-40°C to 85°C (-40°F to 185°F) (excl. HDD/SDD/CFast)		
Humidity	Approx. 95% @ 40°C (non-condensing)		
Vibration	Operating, 5 Grms, 5-500 Hz, 3 axes (w/ CFast or SSD) Operating, 0.5 Grms, 5-500 Hz, 3 axes (w/ HDD)		
ESD	Contact +/-4KV, Air +/-8KV		
Shock	Operating, 100 Grms, half sine 11ms duration (w/ CFast or SSD)		
EMC	CE & FCC Class A		
Safety	UL/cUL, CB, CCC		

*by request

1.3.2 MVP-6015/6025

System Core	
Processor	Intel® Core™ i7-6700 (65W)
Chipset	MVP-6015: H110 MVP-6025: Q170
Video	1 VGA + 2 DisplayPort + 1 DVI-D
Memory	4 GB DDR4 2133 MHz (up to 32 GB)
OS	Win7 32/64-bit, Win 10 64-bit, Linux*
I/O Interface	
Expansion slots	MVP-6015: 1 PCIe Gen3 x16 + 3 PCI expansion slots MVP-6025: 2 PCIe Gen3 x16(x16 slots with x8 signals) + 2 PCI expansion slots
Ethernet	3 Intel® GbE ports 3 Intel® I211AT WOL function on each port Teaming
Serial Ports	4 COM by DB9 connector 2 software-programmable RS-232/422/485 (COM1 & 2) [BIOS select] 2x RS-232 (COM3 & 4) RS-485 supports auto-flow control 2 KV surge protection on RS-422/485
USB	6 external USB ports (4x 3.0 + 2x 2.0) (each supporting 1.6A w/ 1 internal USB 2.0 port for 40 mil/A trace design and 5V ± 5% voltage stability)
DI/O	8CH DI and 8CH DO
Mini PCIe	1 internal
USIM	1
Audio	1 Mic-in and 1 Line out
Power Supply	
DC Input	Built-in 12-24 VDC wide-range DC input 3P pluggable connector with latch (GND, V-, V+)
AC Input	Optional 160W external AC/DC adapter for AC input
Storage	
SATA HDD	1 SATA port for 2.5" HDD/SSD installation (up to 6 Gb/s)
CompactFlash Socket	1 Type II CFast
Mechanical	

Dimensions	220(W) X 210(D) X 208.7(H)mm (8.67" x 8.27" x 8.21")
Weight	4.7 kg (10.36 lbs)
Mounting	Wall mount kit
Environmental	
Operating Temperature	0°C to 40°C
Storage Temperature	-40°C to 85°C (-40°F to 185°F) (excl. HDD/SDD/CFast)
Humidity	Approx. 95% @ 40°C (non-condensing)
Vibration	Operating, 5 Grms, 5-500 Hz, 3 axes (w/ CFast or SSD) Operating, 0.5 Grms, 5-500 Hz, 3 axes (w/ HDD)
ESD	Contact +/-4KV, Air +/-8KV
Shock	Operating, 100 Grms, half sine 11ms duration (w/ CFast or SSD)
EMC	CE & FCC Class A
Safety	UL/cUL, CB, CCC

*by request

1.3.3 Power Consumption

Power Supply (24VDC)	Power Off	System Idle*	System Full Load**	Recommended Power Supply***
Integrated Embedded Computer				
MVP-6011 MVP-6021	2.9 W	19.68 W	53.52 W	160W
MVP-6012 MVP-6022	2.9 W	18.26 W	52.18 W	160W
MVP-6013 MVP-6023	2.9 W	17.9 W	50.66 W	160W
MVP-6015 MVP-6025	2.9 W	28.12W	69.56W	160W

*Under Windows 7 desktop with no application programs executed

**Under Windows 7 with 100% CPU utilization and simultaneous access to all I/O devices

***Additional power supply required if add-on cards are installed and in use

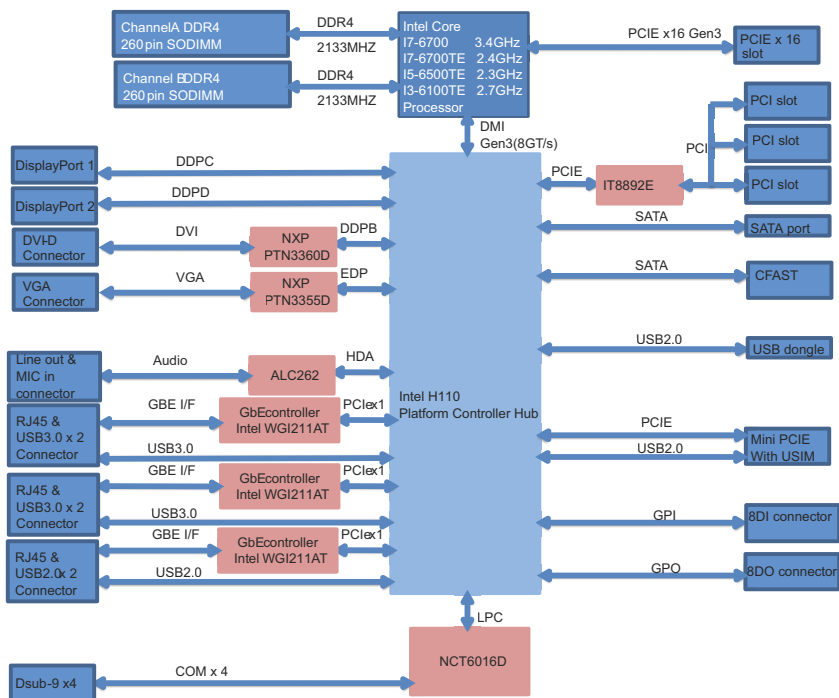

Figure 1-1: MVP-6010 Series Functional Block Diagram

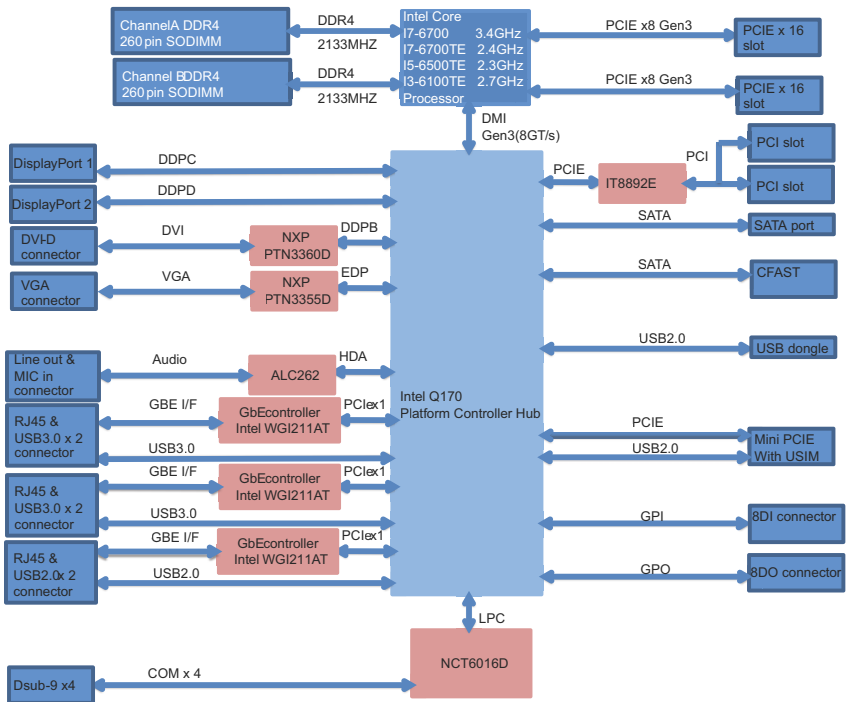

Figure 1-2: MVP-6020 Series Functional Block Diagram

1.4 Schematics and Dimensions



All dimensions shown are in mm (millimeters).

NOTE:

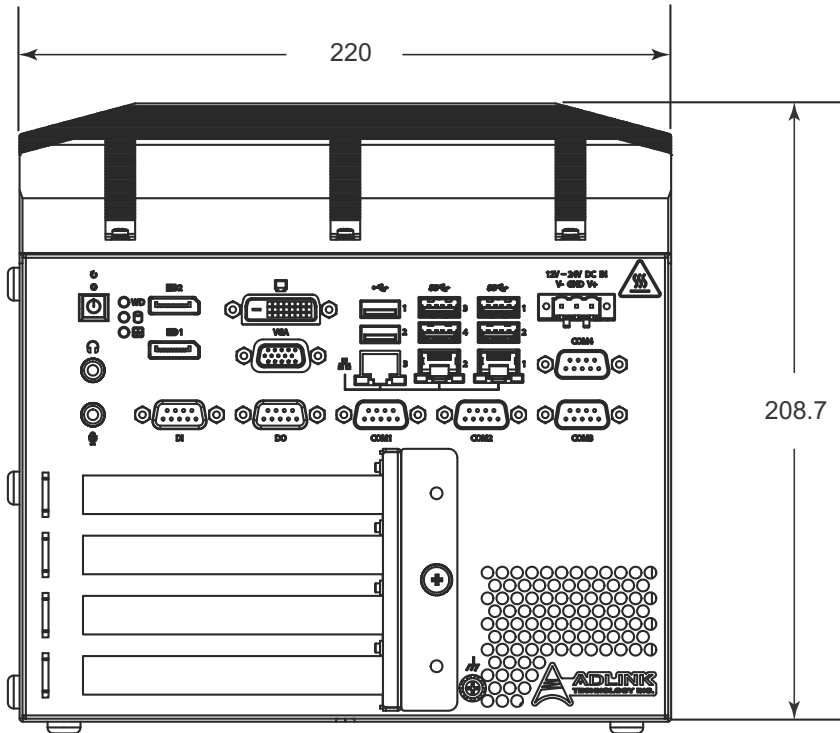

Figure 1-3: Front View

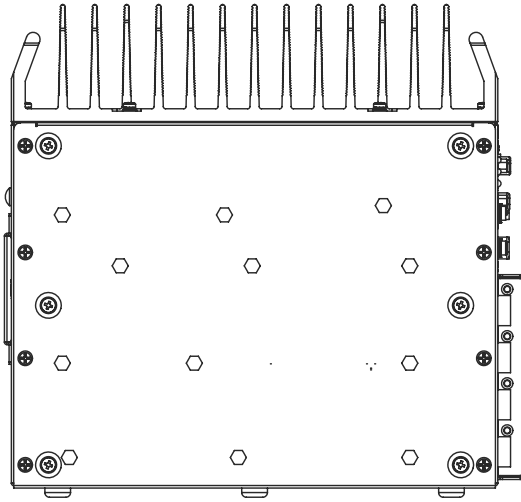

Figure 1-4: Left Side View

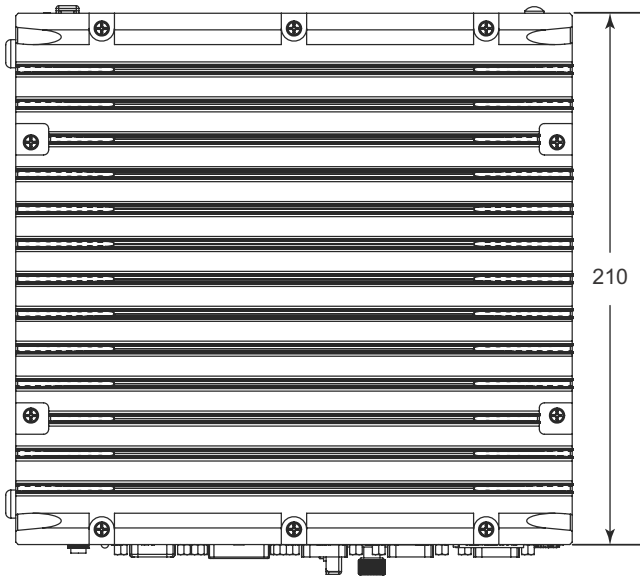

Figure 1-5: Top View

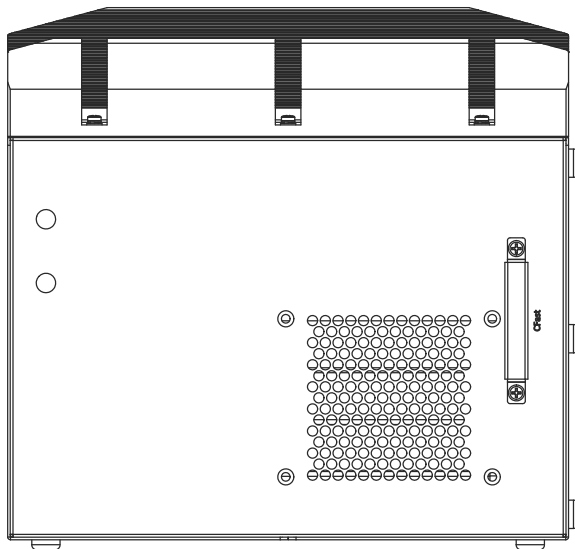

Figure 1-6: Rear View

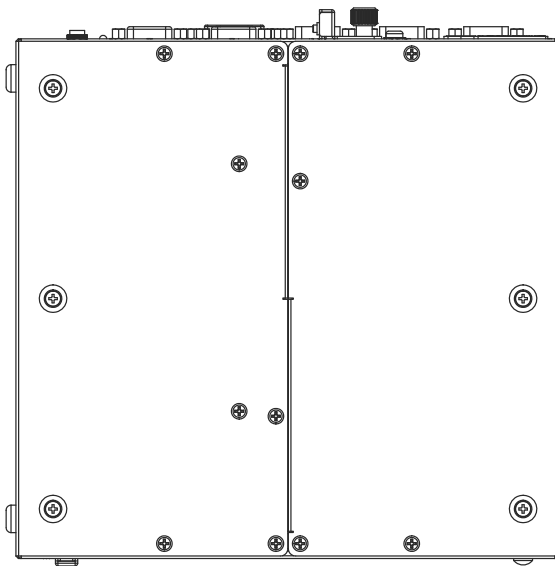

Figure 1-7: Underside View

1.5 Front Panel I/O Connectors

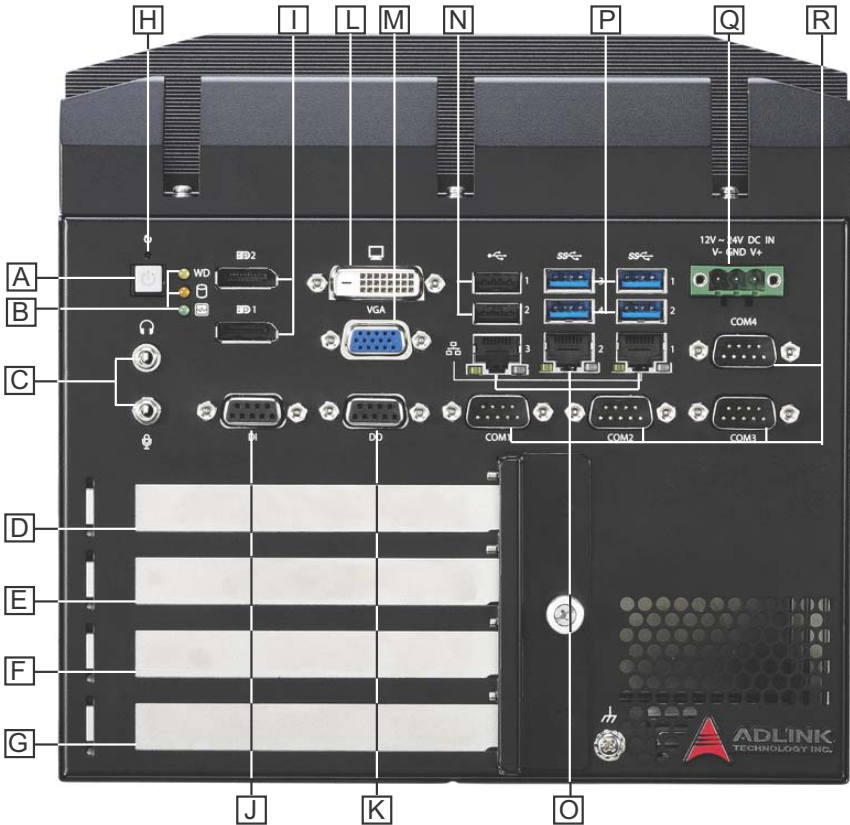

Figure 1-8: Front Panel I/O Connectors

A	Power Button	J	Digital Input
B	LED Indicators	K	Digital Output
C	Audio (Mic, Phones)	L	DVI-D
D	PCI express X16	M	VGA
E	5V 32-Bit PCI	N	USB 2.0 (Type A) x2
F	5V 32-Bit PCI	O	Gigabit Ethernet x3
G	5V 32-Bit PCI	P	USB3.0 (Type A) x4

H	Reset Button	Q	DC power supply
I	DisplayPort x2	R	COM port x4

Table 1-1: MVP-6010 Series Front Panel I/O Connector Legend

A	Power Button	J	Digital Input
B	LED Indicators	K	Digital Output
C	Audio (Mic, Phones)	L	DVI-D
D	PCI express X16	M	VGA
E	PCI express X16	N	USB 2.0 (Type A) x2
F	5V 32-Bit PCI	O	Gigabit Ethernet x3
G	5V 32-Bit PCI	P	USB3.0 (Type A) x4
H	Reset Button	Q	DC power supply
I	DisplayPort x2	R	COM port x4

Table 1-2: MVP-6020 Series Front Panel I/O Connector Legend

1.5.1 Power Button

The power button is a non-latched push button with a blue LED indicator. System is turned on when the button is depressed, and the power LED lights. If the system hangs, depress the button for 5 seconds to turn off the system completely.

1.5.2 LED Indicators

In addition to the LED of the power button, three LEDs on the front panel indicate the following.

LED indicator	Color	Description
Watchdog (WD)	Yellow	Indicates watchdog timer status. When watchdog timer starts, the LED flashes. When the timer is expired, the LED remains lit..
Hard disk drive (HD)	Orange	Indicates the HDD operating state. When the SATA hard drive or CFast card is active, the LED indicator flashes.
Diagnostic (DG)	Green	When lit continuously, indicates no physical storage is connected, and if blinking, indicates no memory is installed on either SODIMM socket.

Table 1-3: LED Indicators

1.5.3 PCI Slot

The MVP-6010/MVP-6020 provides PCI slots for expansion. Based on the ITE IT8892E PCIe to PCI bridge, connection to the host system is achieved through a PCIe x1 Gen3 interface, supporting universal or 5V PCI 32-bit cards operating at 33MHz clocks.

1.5.4 PCI Express x16 Slot

For the MVP-6010, one PCI express x16 slot supports expansion with standard PCIe Gen3 cards and full PCI express x16 signals.

For the MVP-6020, two PCI express x16 slots support expansion with standard Cle Gen3 cards and x8 signals.

1.5.5 Reset Button

The reset button executes a hard reset for the MVP-6010/MVP-6020.

1.5.6 DisplayPort Connectors

Two DisplayPort connectors on the front panel can connect to VGA, DVI, HDMI and DisplayPort monitors via DisplayPort to VGA adapter cable, DisplayPort to DVI adapter cable, or DisplayPort to HDMI adapter cable and DisplayPort cable.

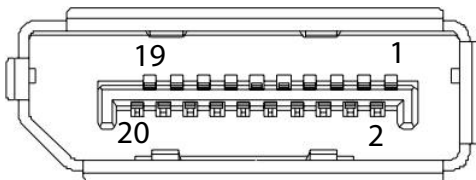

Figure 1-9: DisplayPort Connector

Pin	Signal	Pin	Signal
1	CN_DDPx0+	11	GND
2	GND	12	CN_DDPx3-
3	CN_DDPx0-	13	CN_DDPx_AUX_SEL
4	CN_DDPx1+	14	CN_DDPx_CONFIG2
5	GND	15	CN_DDPx_AUX+
6	CN_DDPx1-	16	GND
7	CN_DDPx2+	17	CN_DDPx_AUX-
8	GND	18	CN_DDPx_HPD
9	CN_DDPx2-	19	GND
10	CN_DDPx3+	20	+V3.3_DDPx_PWR_CN

Table 1-4: DisplayPort Pin Assignments

P/N	Description
30-01119-0010	Passive DisplayPort to HDMI adapter cable
30-01120-0010	Passive DisplayPort to DVI adapter cable
30-01121-0010	Passive DisplayPort to VGA adapter cable
30-01157-0010	Active DisplayPort to DVI adapter cable

Table 1-5: Applicable Cable Types

Display Options

With computing and graphic performance enhancement from its 6th Generation Intel processor, the MVP-6010/MVP-6020 controller can support two independent displays, with configuration as follows.

Display Option 1	Display Option 2
DisplayPort1 4096x2304@60Hz	DisplayPort2 4096x2304@60Hz
DisplayPort1 4096x2304@60Hz	DVI-D 1920x1200@60Hz
DisplayPort1 4096x2304@60Hz	VGA 1920x1080@60Hz
DisplayPort2 4096x2304@60Hz	DVI-D 1920x1200@60Hz
DisplayPort2 4096x2304@60Hz	VGA 1920x1080@60Hz
DVI-D 1920x1200@60Hz	VGA 1920x1080@60Hz

Table 1-6: Maximum Available Resolutions with 2-Display Configuration

1.5.7 Digital I/O Connector

The MVP-6010/MVP-6020 provides 8 channels of non-isolation digital input and 8 channels of non-isolation digital output circuits, with spec and circuits as follows.

8-channel Digital Input

- ▶ VIH: 2 to 5.25V
- ▶ VIL: 0 to 0.8V

8-channel Digital Output

- ▶ Output type: Open drain N-channel
- ▶ MOSFET driver with internal pull high of 200Ω resistance.
- ▶ Source/Sink current for all channels: 24mA
- ▶ VOH: 2.4 to 5V
- ▶ VOL: 0 to 0.5V

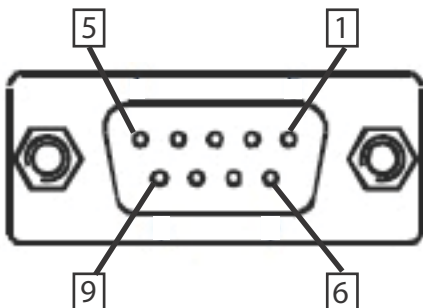

Figure 1-10: Digital I/O Connector Pin Assignment

Pin	Signal
1	DI0
2	DI1
3	DI2
4	DI3
5	DI4
6	DI5
7	DI6
8	DI7
9	DI_GND

Table 1-7: Digital Input Connector Pin Legend

Pin	Signal
1	DO0
2	DO1
3	DO2
4	DO3
5	DO4
6	DO5

Pin	Signal
7	DO6
8	DO7
9	DO_GND

Table 1-8: Digital Output Connector Pin Legend

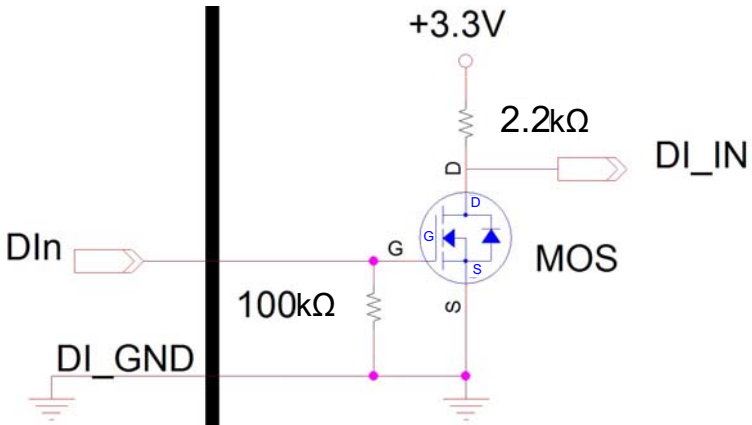

Figure 1-11: Digital Input Circuit

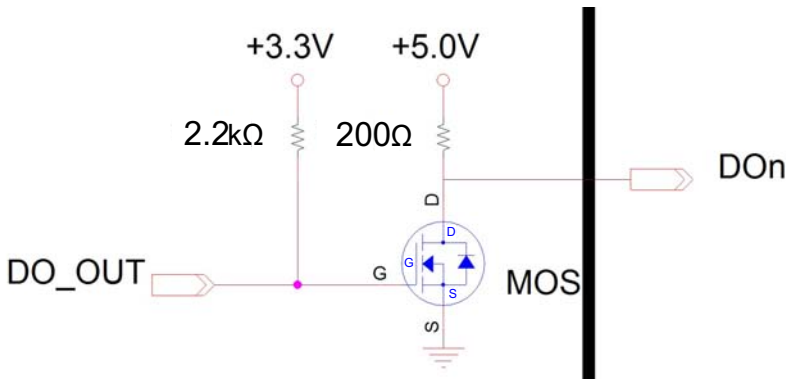

Figure 1-12: Digital Output Circuit

1.5.8 DVI-D Connector

The MVP-6010/MVP-6020 provides one DVI-D connector for connection to an external monitor.

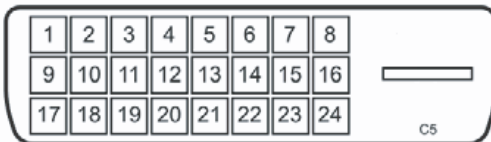

Figure 1-13: DVI-D Connector Pin Assignment

Pin	Signal	Pin	Signal	Pin	Signal
1	DVIdata 2-	9	DVIdata 1-	17	DVIdata 0-
2	DVIdata 2+	10	DVIdata 1+	18	DVIdata 0+
3	GND	11	GND	19	GND
4	N/C	12	N/C	20	N/C
5	N/C	13	N/C	21	N/C
6	DVIDC clock	14	+5V	22	GND
7	DVIDC data	15	GND	23	DVI clock +
8	N/C	16	Hot plug detect	24	DVI clock -

Table 1-9: DVI-D Connector Pin Legend

1.5.9 VGA Connector

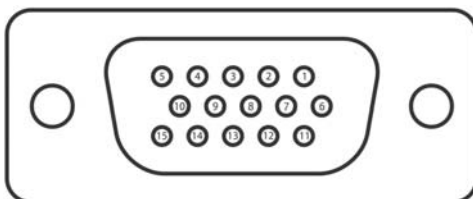

Figure 1-14: VGA Connector Pin Assignment

Pin	Signal
1	G_VGA_R
2	G_VGA_G
3	G_VGA_B
4	N/C
5	GND
6	GND
7	GND
8	GND
9	N/C
10	GND
11	N/C
12	CRT_DDAT_CN
13	G_VGA_HSYNC
14	G_VGA_VSYNC
15	CRT_DCLK_CN

Table 1-10: VGA Connector Pin Legend

1.5.10 USB 2.0 Ports

The MVP-6010/MVP-6020 provides two USB 2.0 ports supporting Type A USB connection on the front panel. All USB ports are compatible with high-speed, full-speed and low-speed USB devices. The MVP-6010/MVP-6020 supports multiple boot devices, including USB flash drive, USB external hard drive, USB floppy, USB CD-ROM and others. The boot priority and boot device can be configured in BIOS. Please refer to Section B.4: Boot on page 68 for details.

1.5.11 Gigabit Ethernet Ports

Three Gigabit Ethernet ports on the front panel support Intel WGI211AT Gigabit Ethernet PHY control.

WGI211AT provides:

- ▶ IEEE 802.3az Energy Efficient Ethernet
- ▶ IEEE 1588/802.1AS precision time synchronization
- ▶ IEEE 802.3Qav traffic shaper
- ▶ Interrupt moderation, VLAN support, IP checksum offload
- ▶ RSS and MSI-X to lower CPU utilization in multi-core systems
- ▶ ECC - error correcting memory in packet buffers
- ▶ Wake-On-LAN
- ▶ Preboot eXecution Environment (PXE) flash interface
- ▶ Jumbo frame support



Active/Link Yellow	Speed LED Green/Orange
-----------------------	---------------------------

Figure 1-15: Ethernet Port and LED Legend

LED Color	Status	Description
Yellow	OFF	Ethernet port is disconnected.
	ON	Ethernet port is connected with no activity.
	Flashing	Ethernet port is connected and active.

Table 1-11: Active/Link LED Indicators

LED Color	Status	Description
Green/Orange	OFF	10 Mbps
	Green	100 Mbps
	Orange	1000 Mbps

Table 1-12: Speed LED Indicators

1.5.12 USB 3.0 Ports

The MVP-6010/MVP-6020 provides four USB 3.0 ports supporting Type A USB3.0 connection on the front panel. All USB3.0 ports are compatible with super-speed, high-speed, full-speed and low-speed USB devices.

1.5.13 DC Power Connector

The DC power supply connector of the MVP-6010/MVP-6020 is on the front panel. The power supply connector consists of three pins, V+, chassis ground, and V- from right to left respectively. V+ and V- pins provide DC power input and the chassis ground pin allows connection of the chassis to ground for better EMC compatibility. The DC power input for the MVP-6010/MVP-6020 allows a voltage input range from 12VDC to 24VDC.



Ensure that the DC power supply:

- ▶ is within the input voltage range defined in the specification
- ▶ is stable and low-noise DC
- ▶ provides sufficient operating current

DC power supply over or under voltage, unstable, or of insufficient power may cause system instability and physical damage



Figure 1-16: DC Power Connector

Pin	Signal
1	V+ (DC_IN)
2	GND (CHGND)
3	V- (DGND)

Table 1-13: DC Power Supply Connector Signals

1.5.14 COM Port Connectors

The MVP-6010/MVP-6020 provides four COM ports through D-sub 9 pin connectors. The COM1 & COM2 ports support RS-232/422/485 modes by BIOS setting, while COM3 and COM4 support only RS-232.

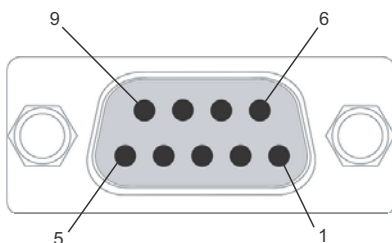

Figure 1-17: COM Port

Pin	Signal Name		
	RS-232	RS-422	RS-485
1	DCD#	TXD422-	485DATA-

Pin	Signal Name		
	RS-232	RS-422	RS-485
2	RXD	TXD422+	485DATA+
3	TXD	RXD422+	N/S
4	DTR#	RXD422-	N/S
5	GND	N/S	N/S
6	DSR#	N/S	N/S
7	RTS#	N/S	N/S
8	CTS#	N/S	N/S
9	RI#	N/S	N/S

Table 1-14: D-Sub 9p Signal Function of COM Ports

1.6 Rear-Mounted CFast Host Connector

The MVP-6010/MVP-6020 is equipped with a Type II Push Push CFlash host connector on the rear panel, by SATA interface. Data transfer rates up to 3.0Gb/s(300MB/s)/1.5Gb/s(150MB/s) are supported. The host SATA controller provides a legacy operating mode using I/O space, and an AHCI operating mode using memory space. The CFast card can function as a storage device for system installation.

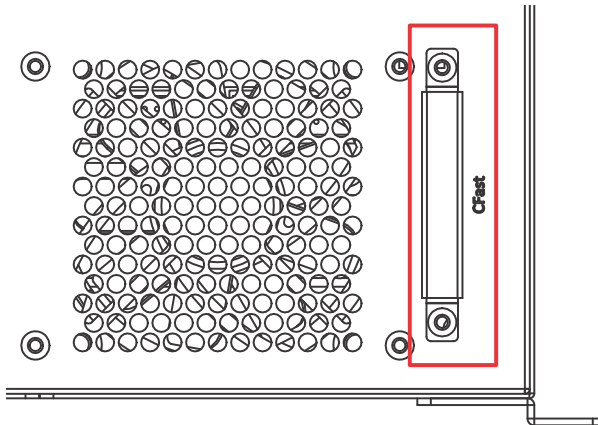

Figure 1-18: CFast Host Connector (on rear panel)

1.7 Internal I/O Connectors

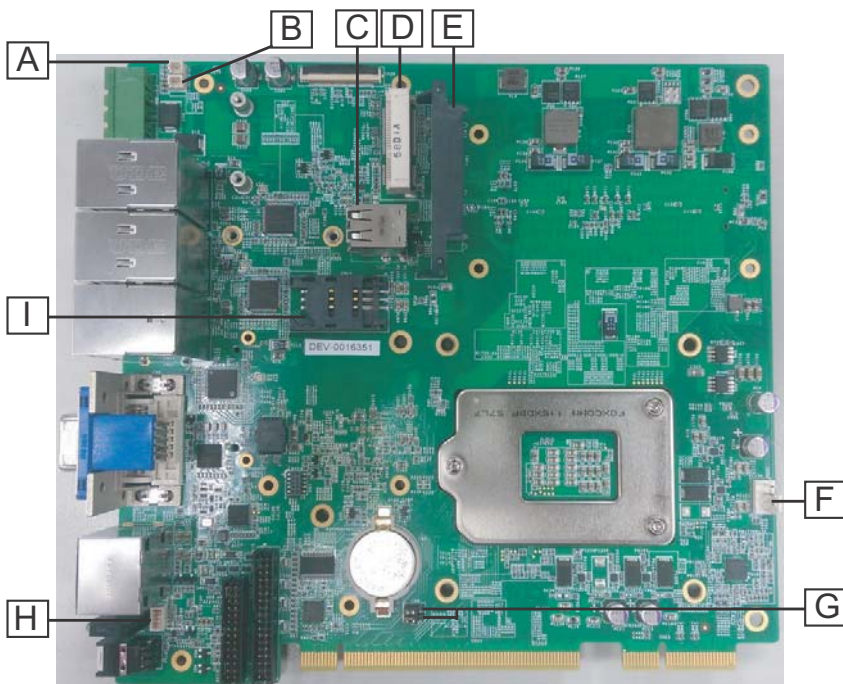

Figure 1-19: Mainboard I/O Connectors

A	GPS module 5V power header
B	GPS module 3.3V power header
C	USB2.0 connector
D	Mini-PCIe connector
E	SATA connector
F	9V fan connector
G	Jumpers: ▶Clear CMOS (upper) ▶N/C (lower)
H	Extended PWR/RESET header
I	USIM slot

Table 1-15: Mainboard Connector Legend

1.7.1 MVP-6010 Series Backplane Connectors

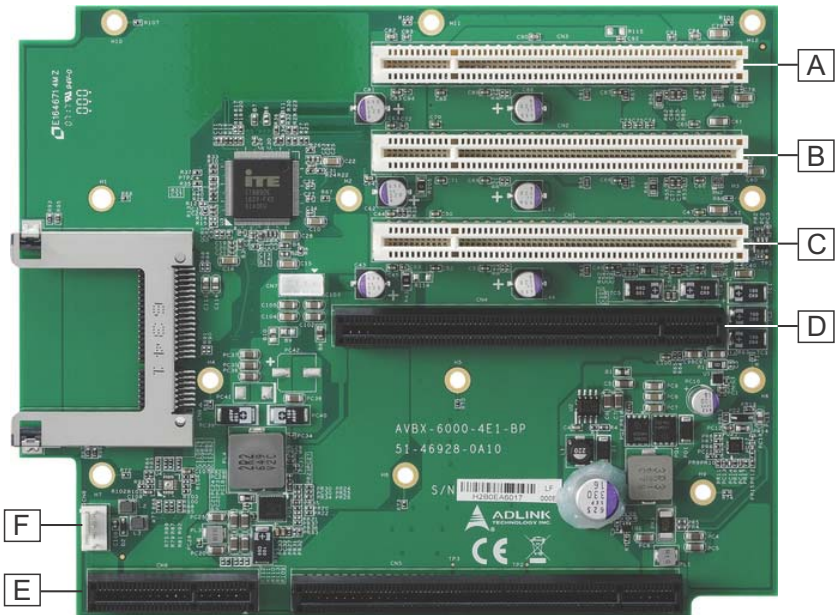

Figure 1-20: MVP-6010 Series Backplane Board PCB

A	PCI
B	PCI
C	PCI
D	PCIe x16
E	Backboard to mainboard PCB connector
F	12V fan connector

Table 1-16: MVP-6010 Series Backplane Board Connector Legend

1.7.2 MVP-6020 Series Backplane Connectors

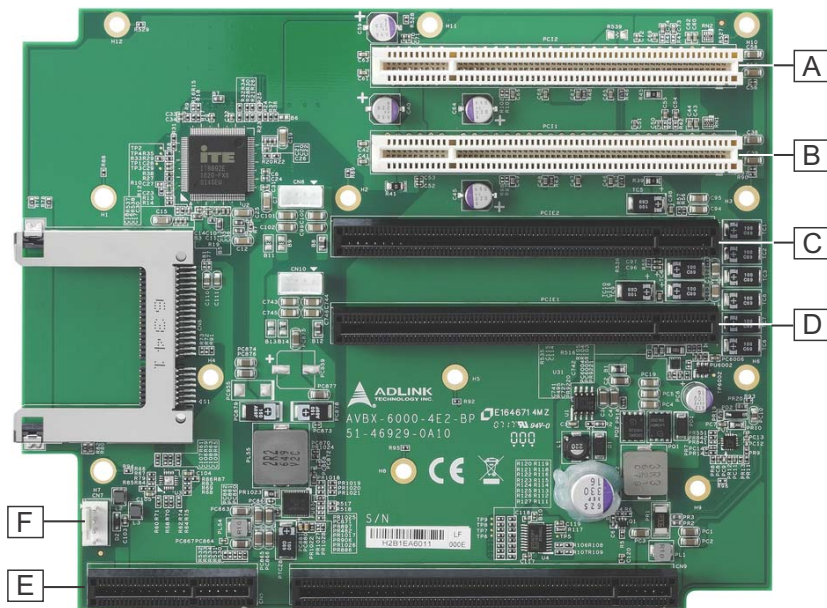

Figure 1-21: MVP-6020 Series Backplane Board PCB

A	PCI
B	PCI
C	PCIe x16
D	PCIe x16
E	Backboard to mainboard PCB connector
F	12V fan connector

Table 1-17: MVP-6020 Series Backplane Board Connector Legend

1.7.3 GPS Module Power Headers

Power supply via cable for mini PCIE GPS module cards is provided in both 5V and 3.3V voltages. Pin #1 is on the right.

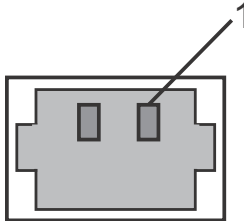

3.3V	
CN16	+V5_GPS
CN17	+V3.3_GPS

Pin	3.3V	5V
1	+V3.3_GPS	+V5_GPS
2	GND	

1.7.4 USB 2.0 Connector

One onboard USB 2.0 Type-A connector is provided for the internal USB dongle, with only the upper port functional.

1.7.5 Mini-PCIe Connector

The internal mini-PCIe connector (Rev. 1.2) supports full size mini-PCIe cards.

1.7.6 SATA Connector

The SATA connector supports transfer up to 6.0Gb/s(600MB/s).

1.7.7 9V Fan Connector

DC 9V fan module power supply is provided through the connector, to which the optional fan module connects when installed in the chassis.

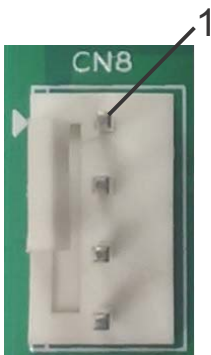

Pin	Signal
1	FAN_GND
2	P_+9V0_FAN1
3	FAN_TACH_CN
4	FAN_PWM_CN

1.7.8 Clear CMOS Jumper

Upon encountering an abnormal condition preventing the MVP-6010/MVP-6020 from booting, the jumper can clear the BIOS content stored in CMOS and restore default settings. To clear CMOS, short pin #2 to pin #3 for a minimum of 3 seconds, and then remove the jumper to return to normal mode.



Figure 1-22: Clear CMOS Jumper Setting

1.7.9 Extended PWR/RESET header

An internal header is provided for the Power and Reset buttons, with pin assignment as shown.

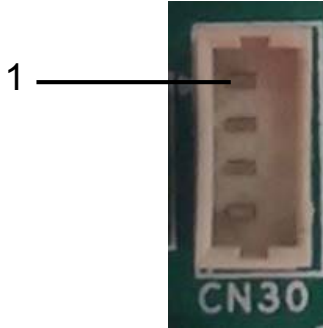

Pin	Signal
1	PWR_BTN-L
2	GND
3	GND
4	RESET_BTN-L

1.7.10 USIM Slot

The USIM slot connects to the Mini-PCle slot.

1.7.11 Internal Reserved +5V and +12V Connector

The MVP-6010/MVP-6020 provides one power pin header with +5V and +12V DC power, providing access for PCI and PCI express card external power supplies.

Please refer to Section A.2:Power Supply Reference for +5V and +12V connector power supply specifications



Pin	Signal
1	+12V
2	GND
3	GND
4	+5V

1.7.12 Backboard to System PCB Connector

This connector connects the backboard to a golden finger-equipped mainboard PCB.

1.7.13 12V DC Fan Connector



Pin	Signal
1	FAN_GND
2	P_+12V0_FAN1
3	FAN_TACH_CN
4	FAN_PWM_CN

The MVP-6010/MVP-6020 provides a DC 12V to USB connector for fan module power. The optional fan module connects to the connector when assembled to the chassis.

This page intentionally left blank.

2 Getting Started

2.1 Unpacking Checklist

Before unpacking, check the shipping carton for any damage. If the shipping carton and/or contents are damaged, inform your dealer immediately. Retain the shipping carton and packing materials for inspection. Obtain authorization from your dealer before returning any product to ADLINK. Ensure that the following items are included in the package.

- ▶ MVP-6010/MVP-6020 controller
- ▶ Accessory pack
- ▶ Screw pack for wall-mounting and HDD installation

2.2 Deployment

The MVP-6010/6020 can be deployed either upright, with the underside on a stable surface, or on its left side, as shown.



Figure 2-1: Upright Deployment



Figure 2-2: Left Side Deployment

2.3 Installing Hard Disk Drives

1. Remove the 16 bottom and side cover screws by screw-driver

..



2. Remove the bottom/side cover by lifting.



3. Use 4 of the included M3 screws to fix a 2.5" HDD or SSD unit to the bracket..



4. Gently depress the drive into the SATA connector on the PCB.



5. Use 4 of the included M3 screws to mount the drive..

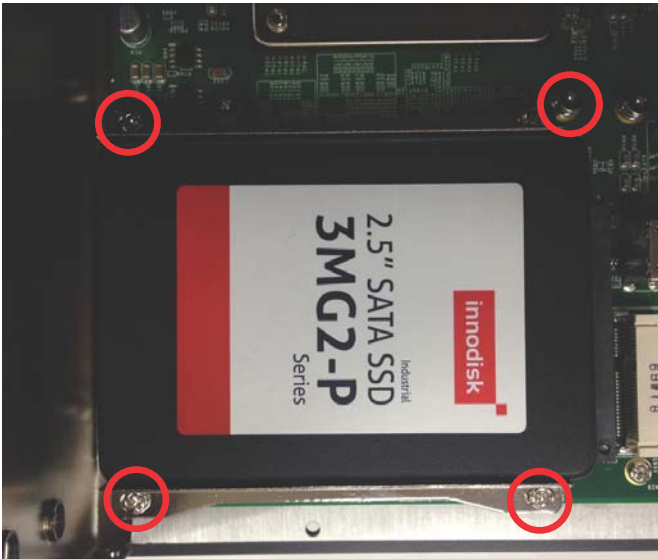

6. Replace the bottom cover and refasten screws.

2.4 Installing a PCI/PCIe Card

Remove the bottom cover as detailed previously.

1. Insert the PCI/PCIe card into the PCI/PCIe slot. True the lower edge of the card with the alignment guide.



2.5 Installing CFast Cards

1. Remove the screws fixing the CFast socket cover.



2. True the CFast card with the alignment guide.



3. Gently insert the CFast card until it is firmly seated in the socket.



4. Replace the socket cover and screws.

2.6 Wall-mounting the MVP-6010/MVP-6020



All dimensions shown are in mm (millimeters).

NOTE:

The MVP-6010/MVP-6020 is shipped with wall-mount brackets and accessory screws.

As with surface deployment (See “Deployment” on page 34) the MVP-6010/MVP-6020 can be wall-mounted in two different configurations, as follows.

2.6.1 Underside Wall-mounting



CAUTION:

While configuration shown may indicate otherwise, due to the presence of ventilation holes, for safety, the device should **ONLY** be wall-mounted with the front and rear panels on the sides, **NEVER** on the top or underside.

1. Remove the 6 plastic pads from the underside panel.

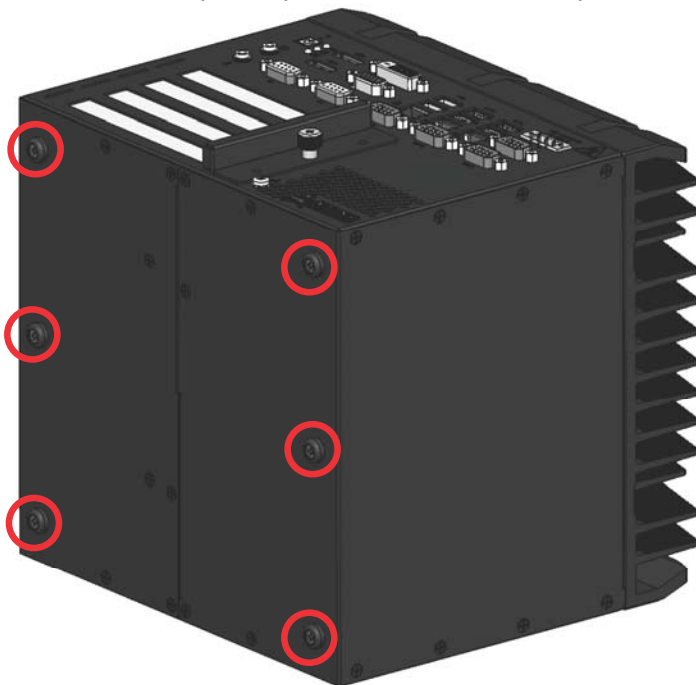

2. Use the 6 M4 screws shipped with the controller to fix the 2 wall-mount brackets, also included, to the chassis, according to the spacing dimensions of the screw holes and brackets, as shown.

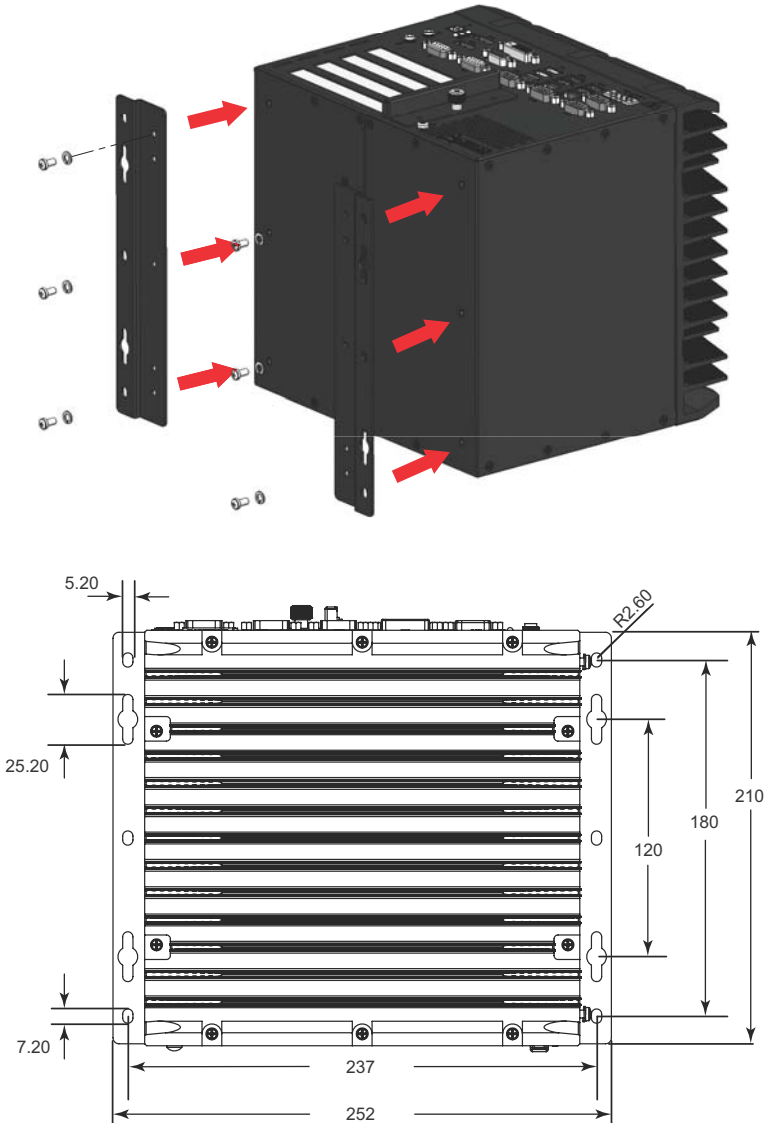

3. Once final assembly as shown is complete, mount the MVP-6010/MVP-6020 on the wall via screw holes.

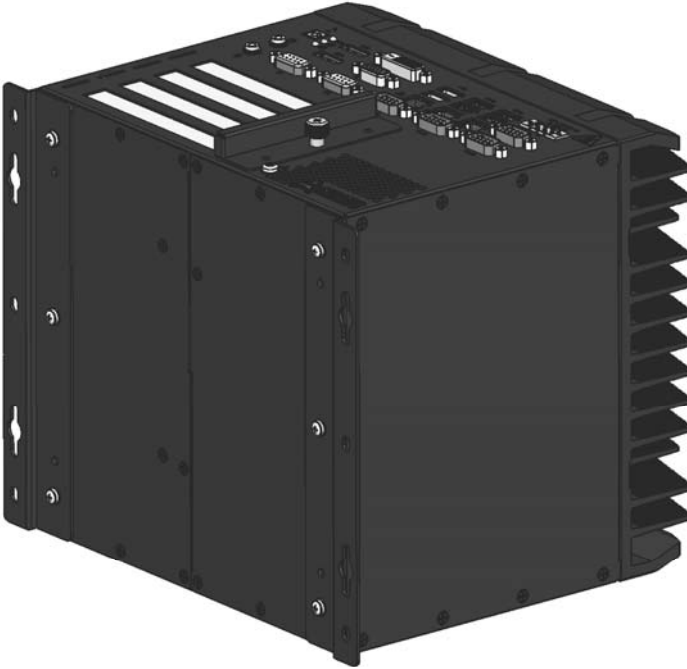

2.6.2 Left Side Wall-mounting

1. Remove the 6 plastic pads from the left side panel.

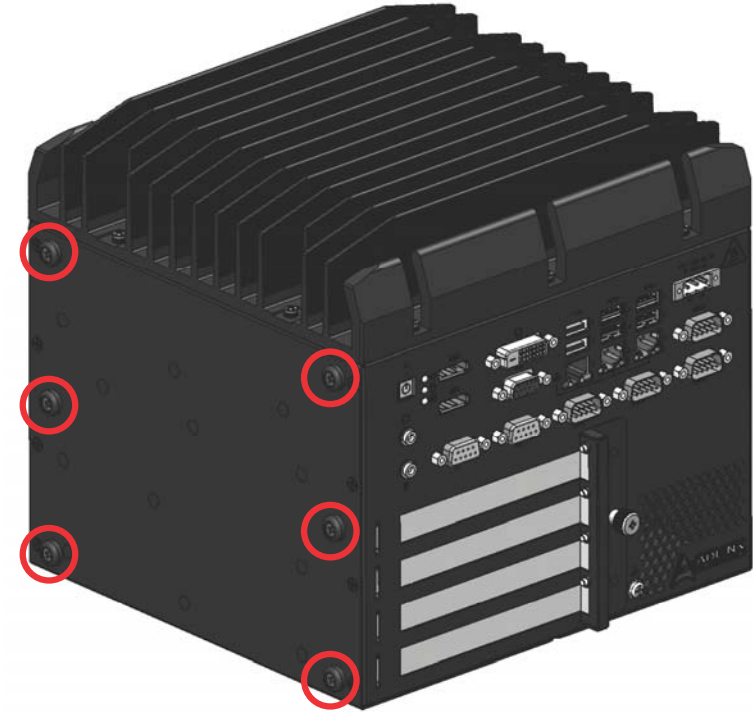

2. Use the 6 M4 screws shipped with the controller to fix the 2 wall-mount brackets, also included, to the chassis, according to the spacing dimensions of the screw holes and brackets, as shown.

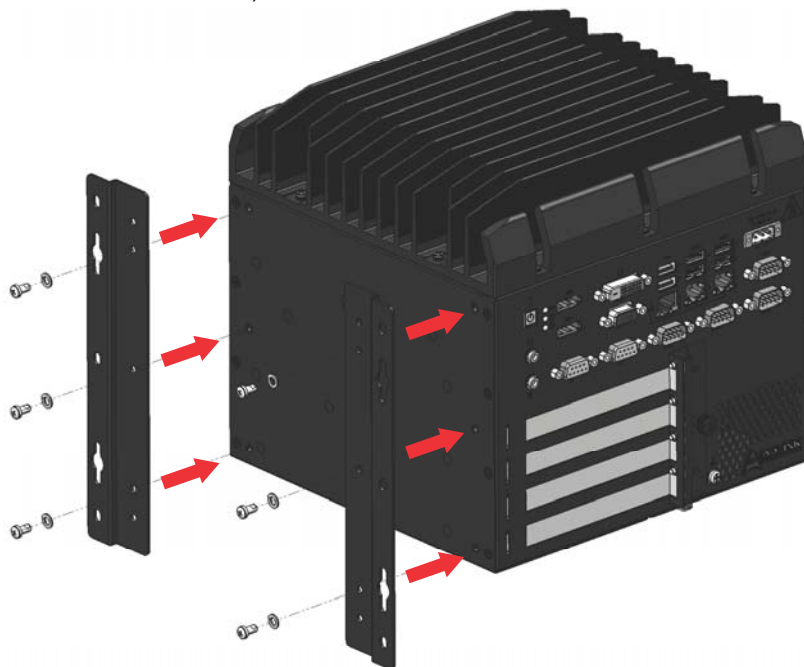

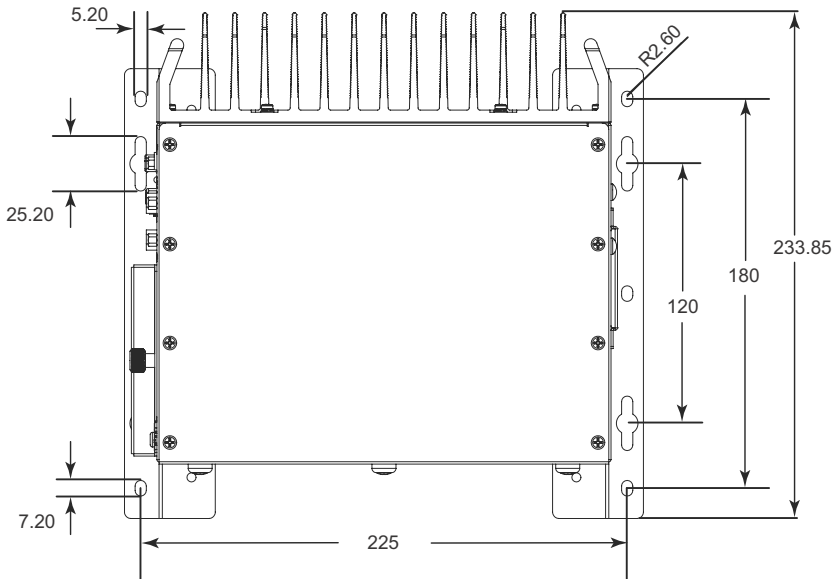

3. Once final assembly as shown is complete, mount the MVP-6010/MVP-6020 on the wall via screw holes.

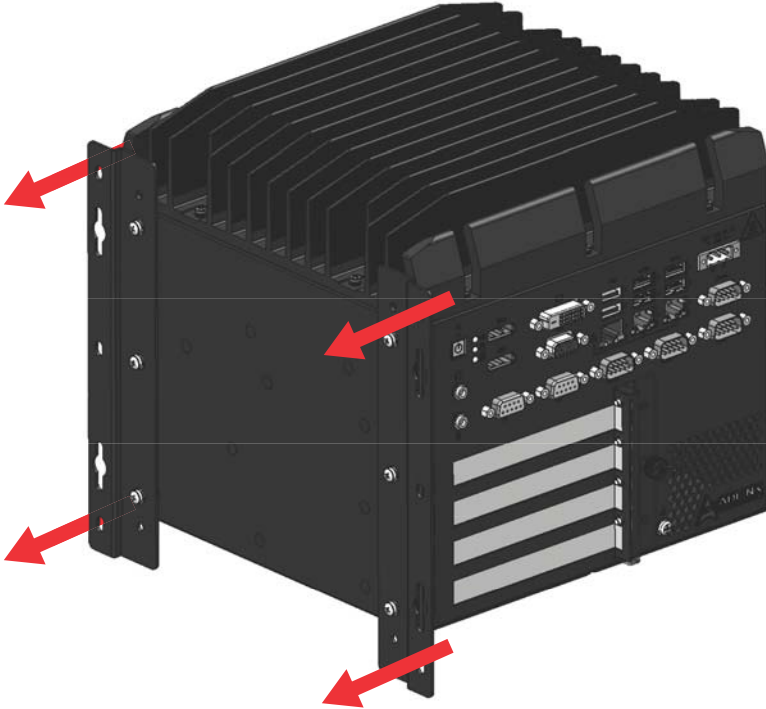

2.7 Driver Installation

Download requisite drivers, as follows, for your system from <http://www.adlinktech.com> and install.

The following drivers must be installed:

- ▶ Chipset driver
- ▶ Graphics driver
- ▶ Ethernet driver
- ▶ Audio driver
- ▶ USB 3.0 driver
- ▶ Intel Management Engine driver
- ▶ Serial I/O driver

Appendix A Power Consumption



NOTE:

Information in this Appendix is for power budget planning and design purposes only. Actual power consumption may differ based on final application.

A.1 Power Consumption Reference

Power consumption as follows is based on lab data in which 24V DC is applied and current is measured by the DC power supply. The power consumption (W) is calculated as the product of applied voltage (V) and the current (A).

Platforms tested for this data have available external I/O interfaces, and are attached to supported devices such as VGA and DVI monitors, CFast card, PS2 keyboard/mouse, USB dummy load, external SATA, COM loopback, and audio loopback, and an internal hard disk driver is installed.

No internal PCI/PCIe/mini PCIe slots are occupied.

Information is presented for reference only. Actual power consumption will vary with different attached devices and platform operations.

Power Supply: 24VDC	Power Off	System Idle	System Full Load	Recommended Power Supply
Integrated Embedded Computer				
MVP-6010/ MVP-6020 i7	2.9 W	19.68 W	53.52 W	160W
MVP-6010/ MVP-6020 i5	2.9 W	18.26 W	52.18W	160W
MVP-6010/ MVP-6020 i3	2.9 W	17.9 W	50.66 W	160W

Table A-1: Power Consumption



NOTE:

- ▶ Sufficient power supply for the entire system is required to meet these specifications. At least 100W at 24V input is recommended.
- ▶ Heat generated by add-on PCI/PCIe adapters affects thermal stability. Additional heat dissipation is required when the system operates at high temperatures or in harsh environments with add-on adapters.
- ▶ Power supply specifications shown are for total power consumption of all PCI/PCIe slots at once, not for single slot use.

A.2 Power Supply Reference

+3.3V Power Rail	Maximum 7A	Total Power Supply Max. 50W
+5V Power Rail	Maximum 5A	
+12V Power Rail	Maximum 2A	
-12V Power Rail	Maximum 0.2A	
CN1 +12V	Maximum 1A	
CN1 +5V	Maximum 1A	

Table A-2: Power Supply

A.3 Accessory Cabling

Power supply to add-on cards is provided by the auxiliary power cable (from CN23 to Molex 8981), Part Number 30-20724-0000.



Yellow	12V	Black	GND
Black	GND	Red	5V

Appendix B BIOS Setup

The Basic Input/Output System (BIOS) is a program that provides a basic level of communication between the processor and peripherals. In addition, the BIOS also contains codes for various advanced features applied to the MVP-6010/MVP-6020. The BIOS setup program includes menus for configuring settings and enabling features of the MVP-6010/MVP-6020. Most users do not need to use the BIOS setup program, as the MVP-6010/MVP-6020 ships with default settings that work well for most configurations.

Enter BIOS setup by selecting DEL when the system is powered on the POST (Power On Self Test) message is displayed. The MVP-6010/MVP-6020 controller supports one-time Boot Menu allowing selection of boot device. Enter the Boot Menu by selecting F7 at POST.



NOTE:

- ▶ BIOS options listed are for reference only.
 - ▶ Different configurations can affect BIOS behavior.
 - ▶ Displayed material may reflect only the BIOS version corresponding to initial release and may differ from that of the purchased motherboard.
 - ▶ Users are welcome to download the latest BIOS version from our official website.
-

B.1 Main

Contains basic system information for the MVP-6010/MVP-6020.



WARNING:

Changing BIOS settings may lead to incorrect controller behavior and possible inability to boot. In such a case, Section 1.7.8: Clear CMOS Jumper provides instruction on clearing the CMOS and restoring default settings



BIOS Information

Shows current system BIOS Vendor, Core Version, BIOS Version, Board Version and Product Name.

Platform Information

Shows current system Platform Name, CPU Stepping, PCH SKU, PCH Stepping and GT information.

FW Information

Shows current system Memory RC version, Microcode Path, IGFX VBIOS version and ME FW version.

System Time/System Date

Allows adjustment of system time and date, as follows.

1. Highlight System Time or System Date using the up and down <Arrow> keys
2. Enter new values using the keyboard and select <Enter>
3. Select < Tab > to move between fields.



NOTE:

- ▶ The date must be entered in MM/DD/YY format, and the time in HH:MM:SS.
- ▶ The time is in 24-hour format. For example, 5:30 A.M. appears as 05:30:00, and 5:30 P.M. as 17:30:00.

B.2 Advanced

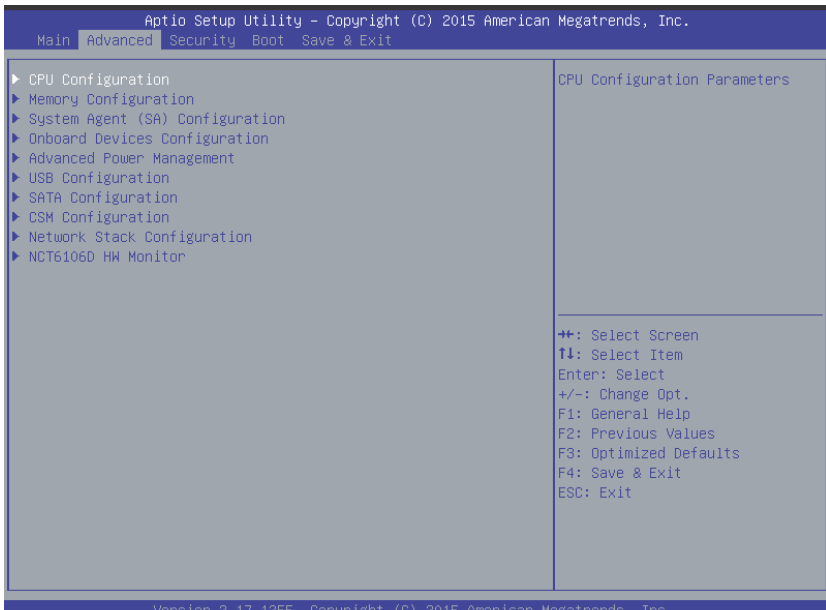

CAUTION:

Setting incorrect or conflicting values in Advanced BIOS Setup may cause system malfunction

Accesses advanced options of the MVP-6010/MVP-6020.

B.2.1 CPU Configuration

Aptio Setup Utility - Copyright (C) 2015 American Megatrends, Inc.

Advanced

CPU Configuration	
Intel(R) Core(TM) i7-6700TE CPU @ 2.40GHz	
CPU Signature	506E3
Microcode Patch	55
Max CPU Speed	2400 MHz
Min CPU Speed	800 MHz
CPU Speed	2400 MHz
Processor Cores	4
Hyper-Threading Technology	Supported
Intel VT-x Technology	Supported
Intel SMX Technology	Supported
64-bit	Supported
EIST Technology	Supported
CPU C3 state	Supported
CPU C6 state	Supported
CPU C7 state	Supported
L1 Data Cache	32 kB x 4
L1 Code Cache	32 kB x 4
L2 Cache	256 kB x 4
L3 Cache	8 MB
L4 Cache	Not Present
Hyper-threading	[Enabled]

Enabled for Windows XP and Linux (OS optimized for Hyper-Threading Technology) and Disabled for other OS (OS not optimized for Hyper-Threading Technology). When Disabled only one thread per enabled core is enabled.

++: Select Screen
 ↑↓: Select Item
 Enter: Select
 +/-: Change Opt.
 F1: General Help
 F2: Previous Values
 F3: Optimized Defaults
 F4: Save & Exit
 ESC: Exit

Version 2.17.1255. Copyright (C) 2015 American Megatrends, Inc.

Aptio Setup Utility - Copyright (C) 2015 American Megatrends, Inc.

Advanced

CPU Speed	2400 MHz	Offset from the factory TCC activation temperature
Processor Cores	4	
Hyper-Threading Technology	Supported	
Intel VT-x Technology	Supported	
Intel SMX Technology	Supported	
64-bit	Supported	
EIST Technology	Supported	
CPU C3 state	Supported	
CPU C6 state	Supported	
CPU C7 state	Supported	
L1 Data Cache	32 kB x 4	
L1 Code Cache	32 kB x 4	
L2 Cache	256 kB x 4	
L3 Cache	8 MB	
L4 Cache	Not Present	
Hyper-threading	[Enabled]	
Active Processor Cores	[All]	
Intel Virtualization Technology	[Enabled]	
CPU AES	[Enabled]	
Intel(R) SpeedStep(tm)	[Disabled]	
CPU C states	[Disabled]	
Intel TXT(LT) Support	[Disabled]	
TCC Activation Offset	0	

++: Select Screen
 ↑↓: Select Item
 Enter: Select
 +/-: Change Opt.
 F1: General Help
 F2: Previous Values
 F3: Optimized Defaults
 F4: Save & Exit
 ESC: Exit

Version 2.17.1255. Copyright (C) 2015 American Megatrends, Inc.

Hyper-Threading

Enabled for Windows XP and Linux (optimized for Hyper-Threading Technology) and Disabled for other OS (not optimized for Hyper-Threading Technology). When Disabled only one thread per enabled core is enabled.

Active Processor Cores

Number of cores to enable in each processor package.

Intel Virtualization Technology

When enabled, a VMM can utilize the additional hardware capabilities provided by Vanderpool Technology.

CPU AES

Enable/Disable CPU Advanced Encryption Standard instructions.

Intel(R) SpeedStep(tm)

Allows more than two frequency ranges to be supported.

CPU C States

Enable or disable CPU C states.

Intel TXT(LT) Support

Enables or Disables Intel(R) TXT(LT) support.

TCC Activation Offset

Offset from the factory TCC activation temperature.

B.2.2 Memory Configuration

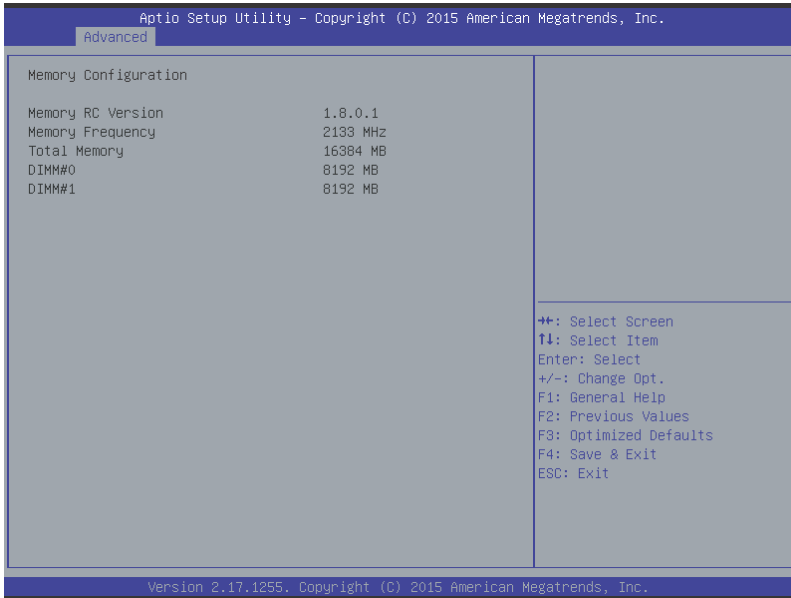

Shows current system Memory RC Version and values for memory frequency, total memory, DIMM#0, and DIMM#1.

B.2.3 System Agent (SA) Configuration

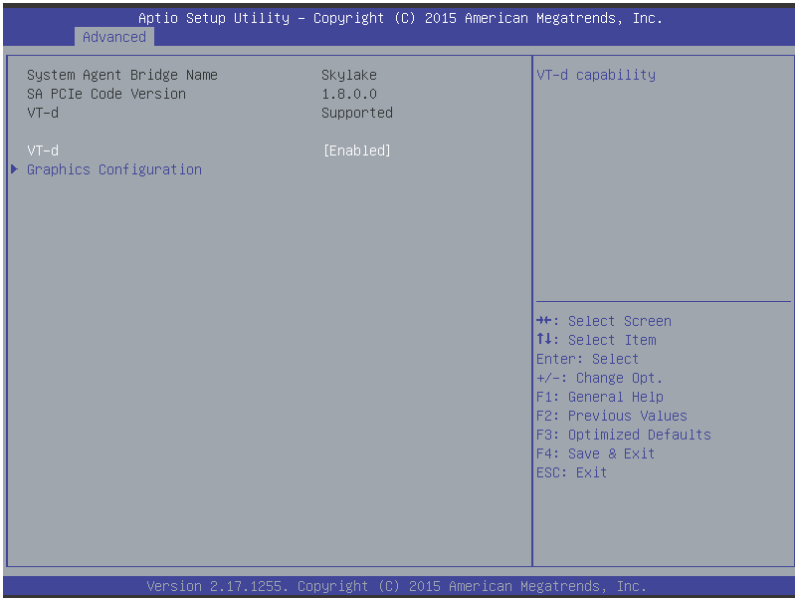

VT-d

Enables/disables VT-d capability.

B.2.4 Graphics Configuration



Primary Display

Sets the IGFX/PEG/PCI graphics device to be primary display.

GTT Size

Sets GTT size.

Aperture Size

Sets aperture size, with MMIO BIOS assignment exceeding 4GB automatically enabled when 2048MB aperture is selected, available when CSM Support is disabled.

DVMT Pre-Allocated

Sets size of DVMT 5.0 pre-allocated (fixed) graphics memory used by the internal graphics device.

DVMT Total Gfx Mem

Sets size of DVMT5.0 total graphic memory used by the internal graphics device.

B.2.5 Onboard Device Configuration

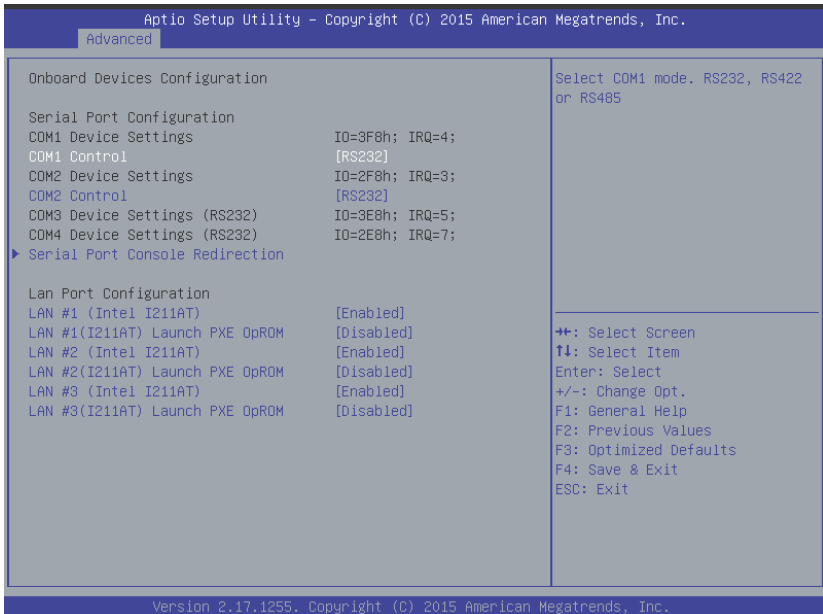

Serial Port 1 to 4 Configuration

Sets port type (RS-232/422/485) for Serial Ports 1 and 2 only.

LAN #1 (Intel I211AT)

Enables/Disables onboard Intel I211AT LAN controller.

LAN #1 (Intel I211AT) Launch PXE OpROM

Enables or disables execution of LAN boot-rom to add boot option for legacy network devices.

LAN #2 (Intel I211AT)

Enables/Disables onboard Intel I211AT LAN controller.

LAN #2(I211AT) Launch PXE OpROM

Enables or disables execution of LAN boot-rom to add boot option for legacy network devices.

LAN #3 (Intel I211AT)

Enables/Disables onboard Intel I211AT LAN controller.

LAN #3(I211AT) Launch PXE OpROM

Enables or disables execution of LAN boot-rom to add boot option for legacy network devices.

Serial Port Console Redirection

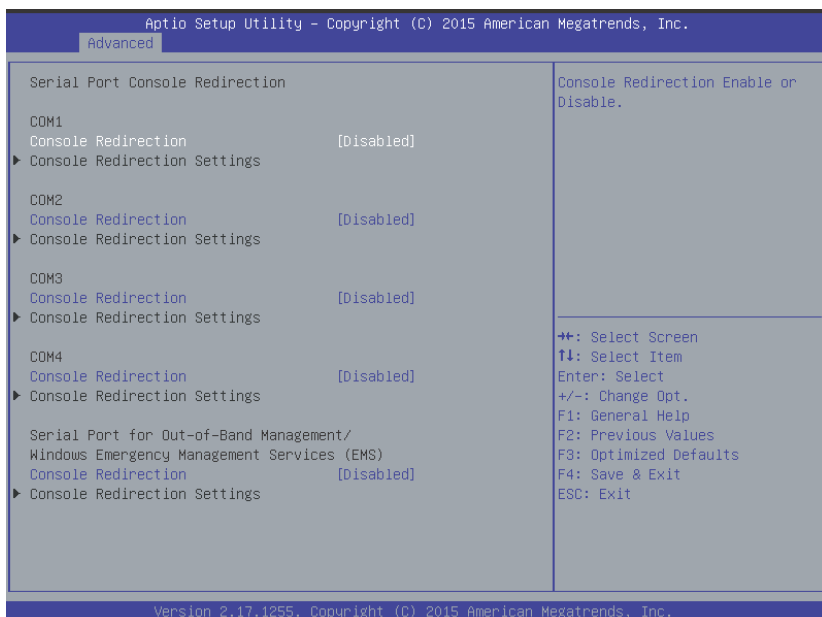

Console Redirection

Enables console redirection on COM 1 to 4 and EMS COM.

Console Redirection Settings

Sets miscellaneous parameters for COM Ports 1 to 4 and EMS COM.

B.2.6 Advanced Power Management

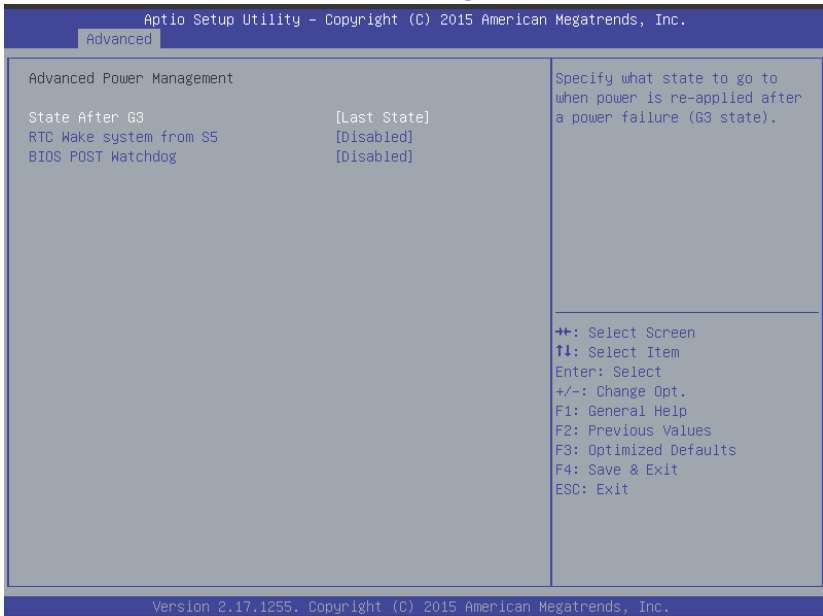

State After G3

Determines the state the computer enters when power is restored after power loss, from among Last State, Power On, and Power Off

Option	Description
Power Off	Retains system power off after power is restored
Power On	Powers the system up when power is restored

Option	Description
Last State	When power is restored, returns the system to the state in which power was interrupted

State After G3

Sets the state entered when power is re-applied after a power failure (G3 state).

RTC Wake system from S5

Enable or disable system wake on alarm event, with FixedTime waking the system at the hr/min/sec specified, and DynamicTime waking the system at the current time + Increase minute(s).

BIOS POST Watchdog

From among Disabled, Second Mode and Minute Mode.

B.2.7 USB Configuration

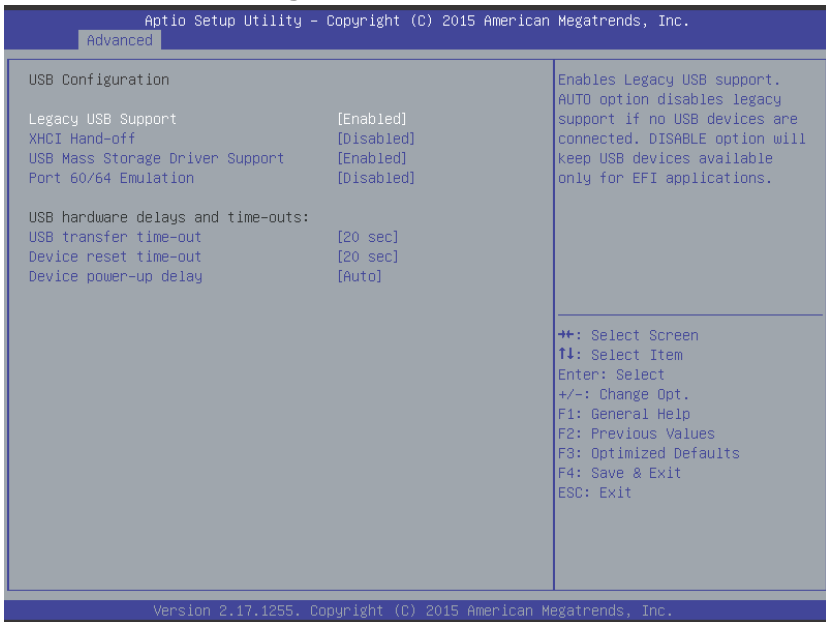

Legacy USB Support

With AUTO disabling legacy support if no USB devices are connected, and DISABLE keeping USB devices available only for EFI applications.

XHCI Hand-off

A workaround for OS without XHCI hand-off support, where XHCI ownership change should be claimed by the XHCI driver.

USB Mass Storage Driver Support

Enable/Disable USB mass storage driver support.

Port 60/64 Emulation

Enables I/O port 60h/64h emulation support, should be enabled for complete USB keyboard legacy support for OS not recognizing USB ports.

USB transfer time-out

Timeout value for Control, Bulk, and Interrupt transfers.

Device reset time-out

USB mass storage device Start Unit command timeout.

Device power-up delay

Maximum time taken before the device reports itself to the Host Controller, with Auto using a default value of 100 ms for a Root port, and for Hub port the delay is taken from the Hub descriptor.

B.2.8 SATA Configuration

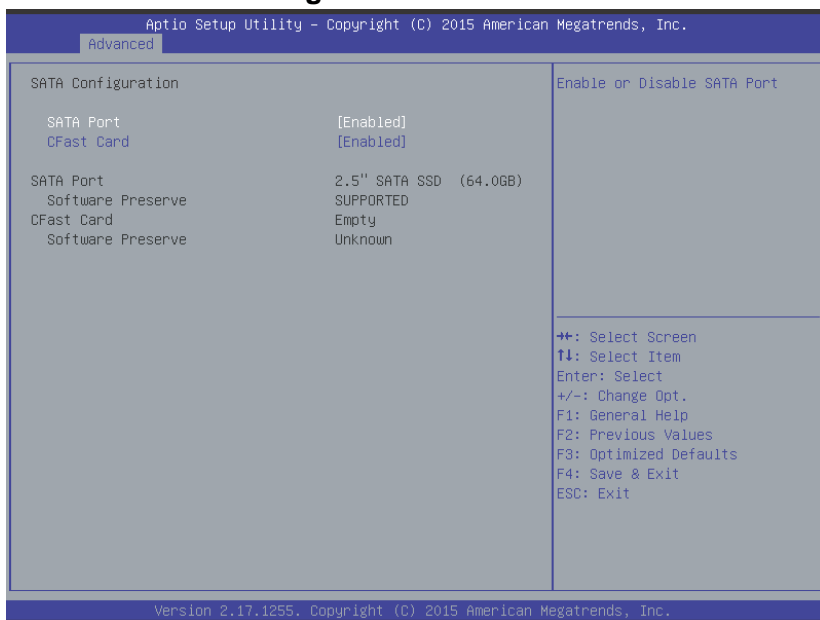

SATA Port and CFast Card

Enable or Disable SATA Port and CFast Card.

for Hub port the delay is taken from the Hub descriptor.

B.2.9 CSM Configuration

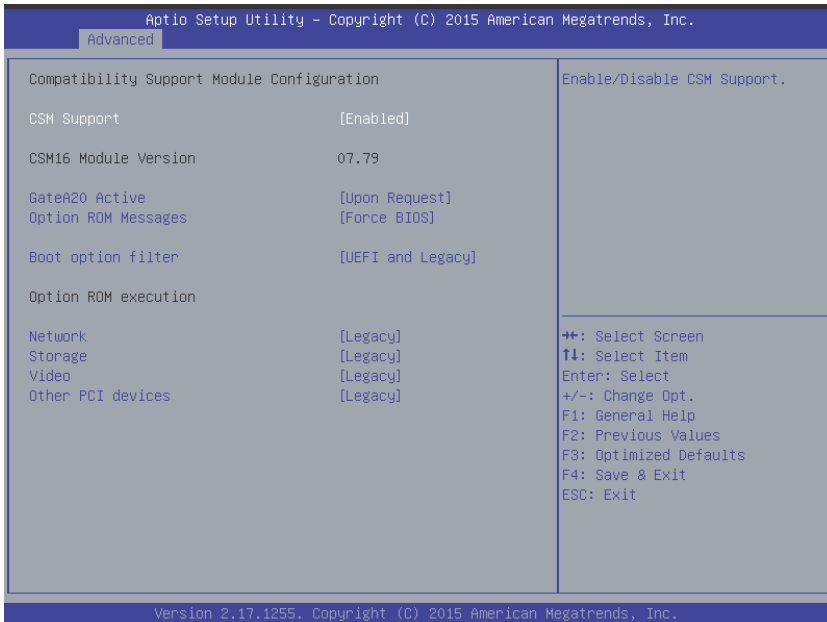

CSM Support

Enable or Disable CSM Support.

GateA20 Active

UPON REQUEST disables GA20 using BIOS services, and ALWAYS prevents GA20 from being disabled, useful when any RT code exceeding 1MB is executed.

Option ROM Messages

Sets display mode for Option ROM.

Boot option filter

Controls Legacy/UEFI ROM priority.

Network

Controls execution of UEFI and Legacy PXE OpROM.

Storage

Controls execution of UEFI and Legacy Storage OpROM.

Video

Controls execution of UEFI and Legacy Video OpROM.

Other PCI devices

Determines OpROM execution policy for devices other than Network, Storage, and Video.

B.3 Security

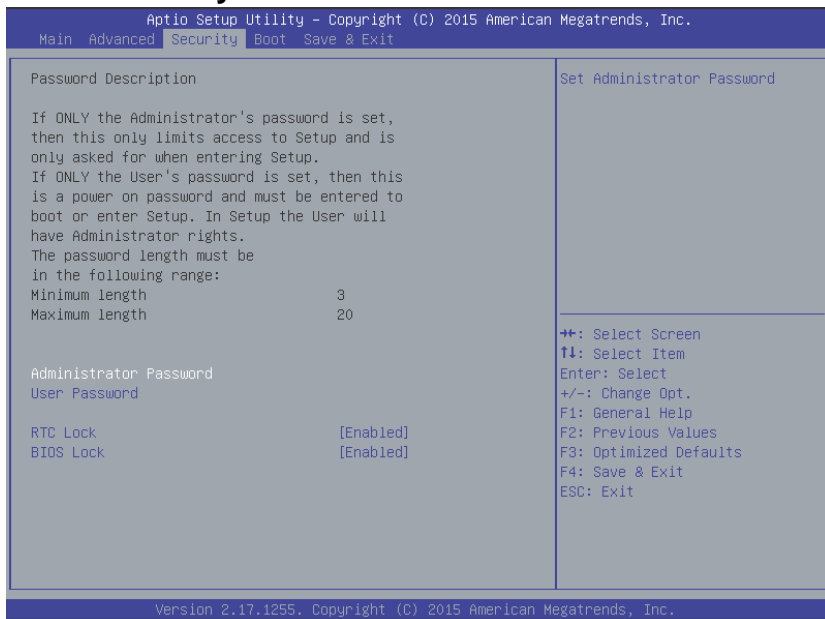

If only the Administrator password is set, access is limited and the password is requested on Setup. If User password is set, it acts as a

power-on password and must be entered to boot or enter setup. In Setup the user receives

Administrator Password

Sets Administrator Password.

User Password

Sets User Password.

RTC Lock

Enable locks bytes 38h-3Fh in the lower/upper 128-byte bank of RTC RAM.

BIOS Lock

Enable/Disable the PCH BIOS Lock (BLE bit).

B.4 Boot



Setup Prompt Timeout

Number of seconds before setup activation key is launched, with 65535(0xFFFF) setting indefinite waiting.

Bootup Num-Lock State

Sets keypad Number Lock status following boot.

Quiet Boot

Option	Description
Disabled	Directs BIOS to display POST messages
Enabled	Directs BIOS to display the OEM logo.

Fast Boot

Option	Description
Disabled	Directs BIOS to perform all POST tests.
Enabled	Directs BIOS to skip certain POST tests to boot faster.

While enabling Fast Boot can reduce system ready time, some prerequisites can reduce effectiveness

Boot Option Priorities

Specifies the priority of boot devices, all of which are detected during POST and displayed. Target Boot Option # and click to select the desired device

Hard Drive BBS Priorities



Specifies the priority of boot devices. All installed boot devices are detected during POST and displayed. Target Boot Option # and click to select the desired device.

B.5 Save & Exit

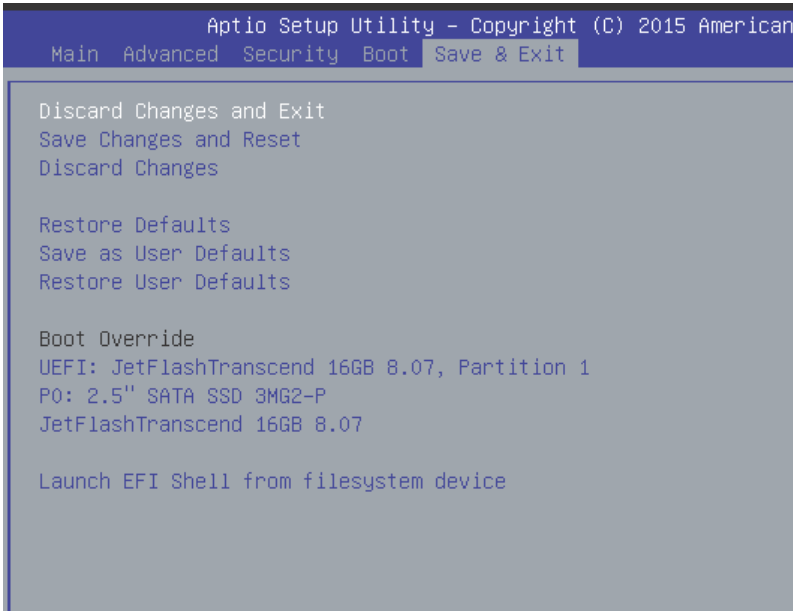

Discard Changes and Exit

Discards all changes and exits BIOS setup

Save Changes and Reset

Saves all changes and reboots the system, with new settings taking effect

Discard Changes

Resets system setup without saving any changes

Restore Defaults

Sets all BIOS options to default settings, designed for maximum system stability but less than maximum performance. Select

Restore Defaults if the computer encounters system configuration problems.

Save as User Defaults

Saves all changes to this point as user defaults

Restore User Defaults

Restores user defaults to all setup options

Launch EFI Shell from filesystem device

Attempts to launch EFI Shell application (Shell.efi) from one of the available filesystem devices

Appendix C Watchdog Timer (WDT) Function Library

This appendix describes use of the watchdog timer (WDT) function library for the MVP-6010/MVP-6020 controller. The watchdog timer is a hardware mechanism provided to reset the system if the operating system or an application stalls. After starting, the watchdog timer in the application must be periodically reset before the timer expires. Once the watchdog timer expires, a hardware-generated signal is sent to reset the system.

C.1 WDT with API/Windows

Matrix WDT API library files and a demo program (incl. source code) can be found on the included driver CD or downloaded from <http://www.adlinktech.com>.

To use the WDT function library for MVP-6010/MVP-6020, include the header file `WDT.h` and linkage library `WDT.lib` in the C++ project.

InitWDT

Initializes the watchdog timer function. Must be called before the invocation of any other WDT function.

Syntax

C/C++

```
BOOL InitWDT()
```

Parameters

None

Return codes

TRUE if watchdog timer is successfully initialized.

FALSE if watchdog timer fails to initialize.

SetWDT

Sets the timeout value of the watchdog timer. There are two parameters for this function to indicate the timeout ticks and

unit. ResetWDT or StopWDT should be called before the expiration of watchdog timer, or the system will reset.

Syntax

C/C++

```
BOOL SetWDT(BYTE tick, BYTE unit)
```

Parameters

tick

Specify the number of ticks for watchdog timer. A valid value is 1 - 255.

unit

Specifies the timeout ticks of the watchdog timer.

Value	Description
0	The unit for one tick is one second. For example, when one tick is specified as 100 and the unit as 0, the timeout value is 100 seconds.
1	The unit for one tick is one minute. For example, when one tick is specified as 100 and the unit as 1, the timeout value is 100 minutes.

Return codes

TRUE if timeout value of watchdog timer is successfully set.

FALSE if timeout value of watchdog timer is failed to set.

StartWDT

Start the watchdog timer function. Once the StartWDT is invoked, the watchdog timer starts. ResetWDT or StopWDT should be called before the expiration of watchdog timer, or the system will reset.

Syntax

C/C++

```
BOOL StartWDT()
```

Parameters

None

Return codes

TRUE if watchdog timer is successfully started.

FALSE if watchdog timer is failed to start.

ResetWDT

Reset the watchdog timer. The invocation of ResetWDT allows restoration of the watchdog timer to the initial timeout value specified in SetWDT function. ResetWDT or StopWDT should be called before the expiration of the watchdog timer, or the system will reset.

Syntax

C/C++

```
BOOL ResetWDT()
```

Parameters

None

Return codes

TRUE if watchdog timer is successfully reset.

FALSE if watchdog timer fails to reset.

StopWDT

Stops the watchdog timer.

Syntax

C/C++

```
BOOL StopWDT()
```

Parameters

None

Return codes

TRUE if watchdog timer is successfully stopped.

FALSE if watchdog timer fails to stop.

C.2 WDT with DOS/Linux

Under Linux, please program WDT function using the same LPC IO registers according to the sample program as follows.

```
#include <dos.h>
#include <stddef.h>
#include <stdio.h>
/* Config LPC IO NCT6102D to enter config mode */
EnterConfig(void)
{
    outp(0x4E, 0x87);
    outp(0x4E, 0x87);
}
/* Config LPC IO to exit config mode */
ExitConfig(void)
{ outp(0x4E, 0xAA);
  }
/* Read byte from LPC IO register */
unsigned char r_reg(unsigned char regoffset)
{ outp(0x4E, regoffset);
  return inp(0x4F); }
/* Write byte to LPC IO register */
void w_reg(unsigned char regoffset, unsigned char
data)
{ outp(0x4E, regoffset); outp(0x4F, data);
}
main(void)
{
    unsigned int    count;
    /* print program title */
    printf("-----MXC-6400                      WDT
Demo-----\n");
```

```

printf("Init          and          config          GPIO
ports<<<<<<<<<<<<<<<<<<<<<<<<<<<<<\n");

printf("-----
----\n");

EnterConfig();
/* config WDT registers */
w_reg(0x07,0x08);
/* enable keyboard interrupt to reset WDT timeout
value */
w_reg(0xF2,r_reg(0xF2)|0x40);
/* set unit as second */
w_reg(0xF0,r_reg(0xF0)&~0x04);
/* start the Watchdog */
w_reg(0x30,0x01);
/* set timeout value as 30 seconds */
/* WDT start automatically while timeout value is set
*/
w_reg(0xF1,0x1E);

printf("-----
----\n");

printf("WDT          is          set          and          counting          down
now.<<<<<<<<<<<<<<<<<<<<<<<\n");

printf("-----
----\n");

for(count=30;count!=0;count--)
{ printf("Countdown %2d :  .\n",count);
/* reset WDT timeout value to 10 seconds */
/* w_reg(0x73,0x0A); */
sleep(1);
}
/* disable WDT */
/* WDT stop while timeout value is set to zero */

```

```
w_reg(0x30,0x00);  
printf("WDT is disable. Program is terminating.");  
ExitConfig();  
return 0;  
}
```

Appendix D Digital Input/Output Function Library

DI/O provides input/output to support inter-device communications. Simple programming guides allow easy transmission of digital signals between the system and attached peripherals.

DI/O with API/Windows

Matrix DI/O API library files and a demo program (incl. source code) can be downloaded from <http://www.adlinktech.com>.

To use the DI/O function library for MVP-6010/MVP-6020 series, include the header file `awl.h` and linkage library `awl.lib` in the C++ project. DI/O functions are as follows.

AwlDioGetValue

Reads the digital logic state of a digital input line.

Syntax

C/C++

```
int __stdcall AwlDioGetValue(int Index)
```

Parameter(s)

Index

Indexes the digital logic state of MVP-6010/MVP-6020 digital input channels 1 to 8 (bit 0 to 7)

Return codes

0: Operation Success

-1: Operation Failed

AwlDioSetValue

Sets the digital logic state of the digital output line.

AwlDioGetValue

Reads the digital logic state of a digital input line.

Syntax

C/C++

```
int __stdcall AwlDioGetValue(int Index , int Value)
```

Parameter(s)

Index

Indexes the digital logic state of MVP-6010/MVP-6020 digital input channels 1 to 8 (bit 0 to 7)

Value

Sets the digital logic state of MVP-6010/MVP-6020 digital output channels 1 to 8 (bit 0 to 7) to 0 or 1.

Return codes

- 0: Operation Success
- 1: Operation Failed

Important Safety Instructions

For user safety, please read and follow all instructions, Warnings, Cautions, and Notes marked in this manual and on the associated device before handling/operating the device, to avoid injury or damage.

S'il vous plaît prêter attention stricte à tous les avertissements et mises en garde figurant sur l'appareil , pour éviter des blessures ou des dommages.

- ▶ Read these safety instructions carefully
- ▶ Keep the User's Manual for future reference
- ▶ Read the Specifications section of this manual for detailed information on the recommended operating environment
- ▶ The device can be operated at an ambient temperature of 50°C
- ▶ When installing/mounting or uninstalling/removing device; or when removal of a chassis cover is required for user servicing (See "Getting Started" on page 33.):
 - ▷ Turn off power and unplug any power cords/cables
 - ▷ Reinstall all chassis covers before restoring power
- ▶ To avoid electrical shock and/or damage to device:
 - ▷ Keep device away from water or liquid sources
 - ▷ Keep device away from high heat or humidity
 - ▷ Keep device properly ventilated (do not block or cover ventilation openings)
 - ▷ Always use recommended voltage and power source settings
 - ▷ Always install and operate device near an easily accessible electrical outlet
 - ▷ Secure the power cord (do not place any object on/over the power cord)
 - ▷ Only install/attach and operate device on stable surfaces and/or recommended mountings
- ▶ If the device will not be used for long periods of time, turn off and unplug from its power source

- ▶ Never attempt to repair the device, which should only be serviced by qualified technical personnel using suitable tools
- ▶ A Lithium-type battery may be provided for uninterrupted backup or emergency power.



Risk of explosion if battery is replaced with one of an incorrect type; please dispose of used batteries appropriately.

Risque d'explosion si la pile est remplacée par une autre de type incorrect. Veuillez jeter les piles usagées de façon appropriée.

- ▶ The device must be serviced by authorized technicians when:
 - ▷ The power cord or plug is damaged
 - ▷ Liquid has entered the device interior
 - ▷ The device has been exposed to high humidity and/or moisture
 - ▷ The device is not functioning or does not function according to the User's Manual
 - ▷ The device has been dropped and/or damaged and/or shows obvious signs of breakage
- ▶ Disconnect the power supply cord before loosening the thumbscrews and always fasten the thumbscrews with a screwdriver before starting the system up
- ▶ It is recommended that the device be installed only in a server room or computer room where access is:
 - ▷ Restricted to qualified service personnel or users familiar with restrictions applied to the location, reasons therefor, and any precautions required
 - ▷ Only afforded by the use of a tool or lock and key, or other means of security, and controlled by the authority responsible for the location

	<p>BURN HAZARD</p> <p>Touching this surface could result in bodily injury. To reduce risk, allow the surface to cool before touching.</p> <p><i>RISQUE DE BRÛLURES</i></p> <p><i>Ne touchez pas cette surface, cela pourrait entraîner des blessures.</i></p> <p><i>Pour éviter tout danger, laissez la surface refroidir avant de la toucher.</i></p>
---	--

This page intentionally left blank.

Getting Service

Ask an Expert: <http://askanexpert.adlinktech.com>

ADLINK Technology, Inc.

9F, No.166 Jian Yi Road, Zhonghe District
New Taipei City 235, Taiwan
Tel: +886-2-8226-5877
Fax: +886-2-8226-5717
Email: service@adlinktech.com

Ampro ADLINK Technology, Inc.

5215 Hellyer Avenue, #110
San Jose, CA 95138, USA
Tel: +1-408-360-0200
Toll Free: +1-800-966-5200 (USA only)
Fax: +1-408-360-0222
Email: info@adlinktech.com

ADLINK Technology (China) Co., Ltd.

300 Fang Chun Rd., Zhangjiang Hi-Tech Park
Pudong New Area, Shanghai, 201203 China
Tel: +86-21-5132-8988
Fax: +86-21-5132-3588
Email: market@adlinktech.com

LiPPERT ADLINK Technology GmbH

Hans-Thoma-Strasse 11
D-68163 Mannheim, Germany
Tel: +49-621-43214-0
Fax: +49-621 43214-30
Email: emea@adlinktech.com

Please visit the Contact page at **www.adlinktech.com** for information on how to contact the ADLINK regional office nearest you:

This page intentionally left blank.