

Operation Manual of EX9132CST-DIO

Serial to TCP/IP Converter w/ DIO



Version 1.0.0.

30.03.2017

Table of Contents

1	Introduction	4
2	Overview	5
2.1	Package Checklist	5
2.2	Block Diagram	5
2.3	Product Features	6
2.4	Product Specifications.....	7
2.5	Interface.....	9
2.6	Block Diagram.....	9
3	EX9132CST-DIO Description & Installation.....	10
3.1	Top view	10
3.2	Down Side	10
3.3	Right Side(Digital I/O(DO*2/ DI*2)).....	10
3.4	Power Supply(Up Side).....	11
3.5	Ethernet LAN Port.....	11
3.6	Reset Button	11
3.7	LED Indicators.....	11
3.8	Wiring Architecture.....	12
4	EX9132CST-DIO Converter Configuration	15
4.1	Initial IP Configuration of PC Host.....	15
4.2	Device Management Utility of EX9132CST	15
4.3	Ensure PC Host network segment	15
4.3.1	Add a new IP.....	15
4.3.2	Local Area Connection.....	15
4.3.3	Properties.....	16
4.3.4	Internet Protocol(TCP/IP).....	16
4.3.5	IP address, subnet mask, gateway, DNS server.....	17
4.4	Alternatively.....	17
4.5	Configuration of Converter.....	18
4.5.1	Initial IP Configuration of Converter(Utility of EX9132CST).....	18
4.5.2	Config & Device Setting.....	18

4.5.3	Web browser.....	18
4.5.4	Configuration Page.....	18
4.5.5	Network Setup Page.....	19
4.5.6	RS232 Setup Page.....	20
4.5.7	RS422/485 Setup Page.....	20
5	Testing procedure for data transmission	21
5.1	Hyper Terminal.....	21
5.2	File Name of Connection.....	21
5.3	Choose TCP/IP.....	22
5.4	Converter's IP Address & Socket Port.....	22
5.5	HyperTerminal Window will show up.....	23
5.6	Echo Loop Test.....	23
5.7	If...check every step.....	24
5.8	ForRS485 Testing.....	24
5.9	Sock ports must be differentiate.....	24
5.10	Loop test is successful.....	24
6	DIO Digital Input/Output status.....	25
7	Appendix A(FAQ) & B(Pin Out & Cable Wiring).....	29

1 Introduction

We provide new ways of connecting legacy serial devices to a Local Area Network (LAN) or Wide Area Network (WAN). TCP/IP converters are designed to operate serial ports over 100M bps Ethernet networks. The data is transmitted via TCP/IP protocol. Therefore, control is available via Ethernet, Intranet and Internet. EX9132CST-DIO converter is packaged in a PVC material case well suited for industrial environments. It provides two serial ports with DIO, one is RS-232 and another one is RS422/485(Auto-Detect) . The serial ports operate in common industrial configuration.

EX9132CST-DIO converter is a low-cost, high performance design. By carefully selecting high quality with competitive prices components in the world, the products made network connectivity possible with affordable cost for virtually all kinds of devices.

EX9132CST-DIO is a full set converter device with DIO, one serial ports RS-232 port and another is a RS-422/485(Auto-Detect) and it provides one socket connection port. This operation manual will guide you step by step to learn the various functions of the EX9132CST-DIO converter.

The following topics are covered in this chapter:

- Overview
- Block Diagram
- Product Features
- Product Specifications

2 Overview

EX9132CST-DIO converter is designed to make your industrial serial devices Internet ready instantly. **ST ARM Cortex-M3** CPU of EX9132CST-DIO converters makes them the ideal choice for connecting your RS-232 & RS-422/485 serial device—such as PLCs, meters, and sensors—to an IP-based Ethernet LAN, making it possible for your software to access serial devices anywhere and anytime over a local LAN or the Internet.

ST ARM Cortex-M3 CPU Series converters ensure the compatibility of network software that uses a standard network API (Winsock or BSD Sockets) by providing TCP Server Mode, TCP Client Mode, and UDP Mode. Model EX9132CST-DIO provides 1 socket connection for remote management. ST ARM Cortex-M3 CPU Series' Virtual COM driver and software that works with COM port can be set up to work over a TCP/IP network in no time. This excellent feature preserves your software investment and let you enjoy the benefit of networking your serial devices instantly.

ST ARM-Cortex-M3 CPU series converter supports manual configuration via the handy web browser console and many protocols including TCP, IP, UDP, HTTP, DHCP, ICMP, and ARP. They are the best solution to network your serial devices.

2.1 Package Checklist

ST ARM-Cortex-M3 CPU products are shipped with the following items:

- 1 unit of EX9132CST-DIO converter
- 1 unit of Power Adaptor/Supply(9V/12V/24VDC, 500mA) : Optional
- Quick Installation Guide in Documentation & Software CD
- Din Rail Mounting Kit : Optional

NOTE: Please notify your sales representative if any of the above items is missing or damaged.

2.2 Block Diagram

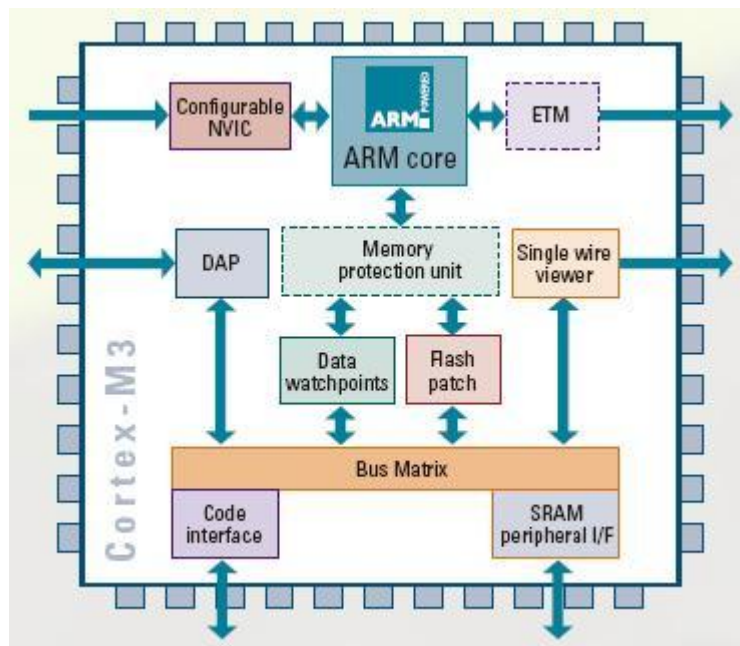

Low-cost devices usually are equipped with low speed processors and limited memories. In reality, they have neither the capability nor practicality to manage complicated network TCP/IP protocols. The ST ARM Cortex™-M3 32-bit processor has been specifically developed to provide a high-performance, low-cost platform for a broad range of applications including microcontrollers, automotive body systems, and industrial control systems, networking by converting data stream between network TCP/IP and popular serial port signals.

Instead of processing TCP/IP packets directly, devices need only deal with those interface signals, which greatly simplifies the complexity of TCP/IP network in linkage. The ST ARM Cortex-M3 processor provides outstanding computational performance and exceptional system response to interrupt while meeting low cost requirements through small core footprint, industry leading code density enabling smaller memories, reducing pin count, and low power consumption.

The central core of ST ARM Cortex-M3 processor, based on a 3-stage pipeline Harvard bus architecture, incorporates advanced features including single cycle multiply and hardware divide to deliver an outstanding efficiency of 1.25 DMIPS/MHz. The ST ARM Cortex-M3 processor also implements the new Thumb®-2 instruction set architecture, which combined with features such as unaligned data storage and atomic bit manipulation delivers 32-bit performance at a cost equivalent to modern 8- and 16-bit devices.

2.3 Product Features

- Data Conversion between RS-232 and Ethernet
EX9132CST-DIO converter device (RS-232* 1 port, RS-422/485*1 port) data/signal into the TCP/IP package data/signal and send them out with the Ethernet Data Stream; or convert the TCP/IP package data/signal into serial device data/signal.
- Socket Communication
EX9132CST-DIO is provided one socket connection.
- Digital I/O Activating (DO*2/ DI*2)
EX9132CST-DIO provides eight TTL of digital I/O.
Convert the sensors' statuses (the sensors are connected to the converter) into the TCP/IP package data and send them out with the Ethernet Data Stream; or use the TCP/IP package data to activate/deactivate the specified digital outputs.
- Dynamic IP Configuration
Support DHCP client mode, simplifying network address configuration and management.
- Dual LAN Speed
Support 10/100 Mbps Ethernet, auto-detected.
- Server / Client Dual Modes
EX9132CST-DIO converter device can be configured as network server or network client. In the client mode, it can be installed in network which is protected by NAT router or firewall without a real IP address.
- Web-based Setup
Parameters setup is based on HTTP protocol by using standard browsers (IE and Netscape). No special software would be required.
- Built-in Security Control
Security protect by login password to prevent intruders.

- Remote Update
Firmware can be updated directly via Ethernet network to keep up with latest network standards.

2.4 Product Specifications

- CPU : ST ARM Cortex™-M3 32-bit processor , 72MHz
- RAM : 64K Bytes SRAM
- ROM : 256K Bytes Flash ROM
- Ethernet
 - Port Type : RJ-45 Connector
 - Speed : 10 /100 M bps (Auto Detect)
 - Protocol: ARP, IP, ICMP, UDP, TCP, HTTP, DHCP, ICMP
 - Mode: TCP Server / TCP Client / UDP Client / Virtual COM / Pairing
 - Setup: HTTP Browser Setup (IE & Netscape)
 - Security: Login Password
 - Protection: Built-in 1.5KV Magnetic Isolation
- Serial Port
 - No. of Ports: RS-232*1 Port and RS-422/485(Auto-Detect)*1 port
 - Port Type: DB9 male * 1 and Terminal Block *1
 - Speed: 300 bps-115.2K bps
 - Parity: None , Odd , Even, Mark, Space
 - Data Bit: 7, 8
 - Stop Bit: 1 , 2
 - Port 1: One RS-232 Signals Port: Rx , Tx , GND , RTS , CTS , DTR , DSR
 - Port 2: One RS-422 /485 Port (Auto-Detect)
 - RS-422 Signals : Rx+ , Rx- , Tx+ , Tx- (Surge & Over Current Protect)
 - RS-485 Signals : Data+ , Data- (Surge & Over Current Protection)
 - Built-in RS422/RS485 Pull High/ Low Resistor
- Digital I/O Port : Output Screw Terminal Voltage 5V/ 12V Seletable
 - Digital Relay Output : Channel * 2
 - Active High/ Low Selectable
 - Relay Coil Voltage: 5V

- Contact Rating :24V@10A/ 120VAC@10A/240VAC@7A
 - LED Lamp : DO-1 ; DO-2
- Digital Input : Channel * 2
 - Active High/ Low Selectable
 - Isolation Voltage : 3750Vrms
 - Status Indicator : 2 Input LED display
 - Wet Contact : Logic 0 : 0~1V Max , Logic 1 : 3.3V ~ 30V Max.
 - LED Lamp : DI-1 ; DI-2
- IP Search Utility : Support Windows 2000 /2003 / XP / Vista / 7/ 8/ 10
- 15KV ESD for all signal
- Watch Dog Function
- Virtual Support Windows 2000 /2003 / XP / Vista /7 /8 /10
- Firmware On-line Updated Via Ethernet
- Power: DC 9 – 24V , 500mA(Terminal Block: optional/ DC Jack: Default)
- LED Lamp:
 - RX, TX, SYS
 - LAN 10/100M LED on RJ45
- Environment:
 - Operating Temperature: -10°C to 70°C
 - Storage Temperature: -20°C to 80°C
- Dimensions: 150 * 120 * 30 (W * D * H)
- Din-Rail and Panel Mounting Optional
- Weight: 900gm
- RoHS: Compliant with RoHS
- Regulatory Approvals: FCC, CE
- Warranty: 1 year

2.5 Interface

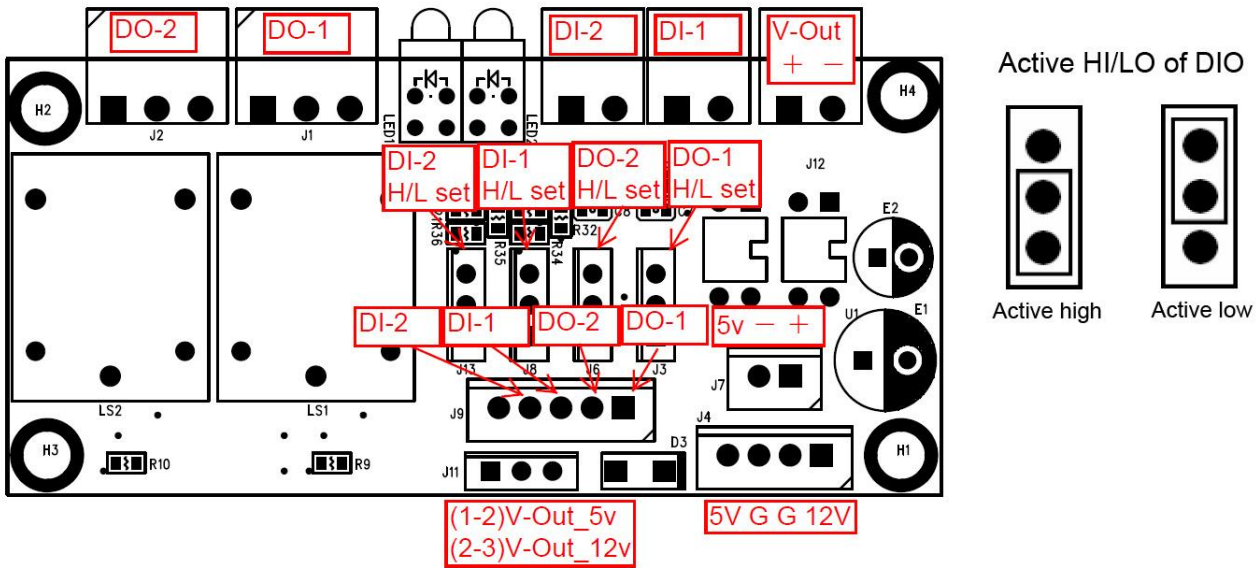

2.6 Block Diagram

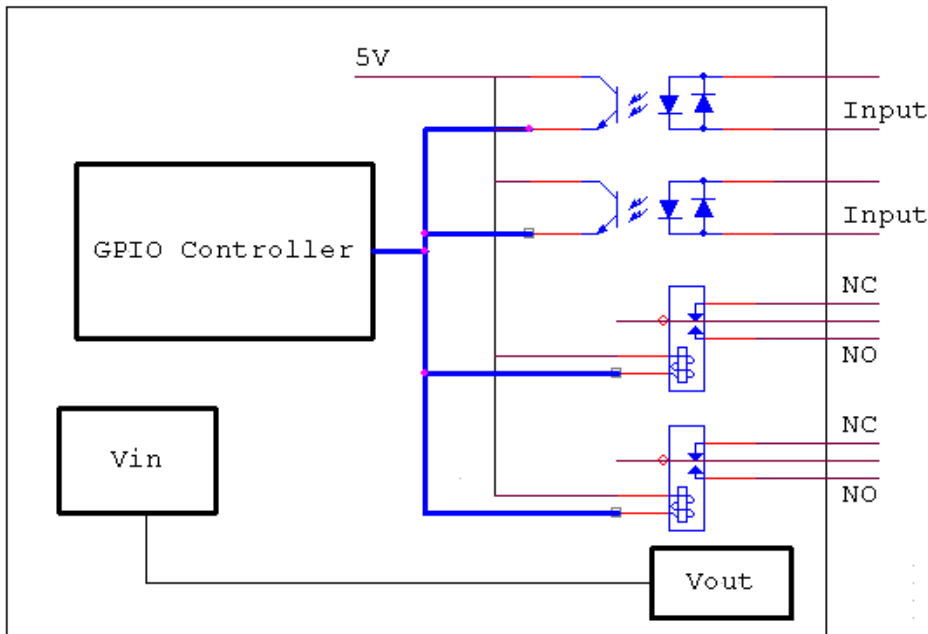

3 EX9132CST-DIO Description & Installation

3.1 Top View



3.2 Down Side

Serial I/O Port of RS-232 & RS-422/485. Connect the serial data cable between the converter device and the serial devices. Follow the parameter setup procedures to configure the converter (see the following chapters).



3.3 Right Side(Digital I/O (DO * 2/ DI*2))

Through EX9132CST-DIO , D I/O(DO-1/DO-2/DI-1/DI-2) can transform the status of sensor into the TCP/IP package data and send out by Ethernet Data Stream (The EX9132CST-DIO must indicate the IP address and COM Port) or activate the indicated Digital output (Remote WinSock must indicate the EX9132CST-DIO). Connect the data wires between the EX9132CST-DIO and the RS-232/422/485 device. Follow the parameter setup procedures to configure the converter (see the following chapters).



3.4 Righ Power Supply(Up Side)

EX9132CST-DIO TCP/IP converter device is powered by a single 9/12/24VDC (inner positive/outer negative) power supply and 500mA of current. A suitable power supply adapter is part of the packaging. Connect the power line to the power jack at the left side of EX9132CST-DIO TCP/IP converter device and put the adapter into the socket.



3.5 Ethernet LAN Port

The connector for network is the usual RJ45. Simply connect it to your network switch or Hub. When the connection is made, the LAN LED indicator will light up. When data traffic occurs on the network, red DATA LED indicator will blink during data transferring and receiving.

3.6 Reset Button

If by any chance, you forget the setup password, or have incorrect settings making EX9132CST-DIO converter inoperable. First, turn on the power. Second, use any point tip to push this button and hold it about 3~4 seconds All the parameters will be reset to the factory default. But do not over 5 seconds , it will enter update mode.

3.7 LED Indicators

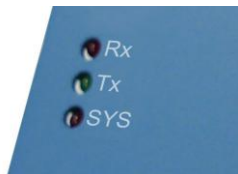

- RX (Red): When data are receiving to the network, the LED will blink
- TX (Green): When data are sending to the network, the LED will blink
- SYS (Green): It is a device statuses indicator
- DI_1(Green): status of Digital input channel 1
- DI_2(Red): status of Digital input channel 2
- DO_1(Green): status of Digital output channel 1
- DO_2(Red): status of Digital output channel 2

3.8 Wiring Architecture

RS-232 Wiring Architecture



RS-422/485 Wiring Architecture



When you finish the steps mentioned above and the LED indicators are as shown in above diagram, the converter is installed correctly. You can use the Setup Tool "EX9132CST.exe" to setup the IP Address.

To proceed the advanced parameter setup, please use a web browser (IE or Netscape) to continue the detailed settings.

- Digital Output:

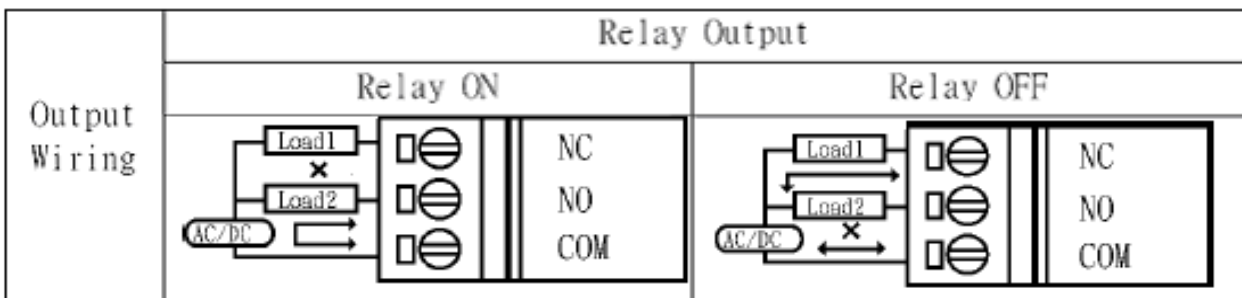
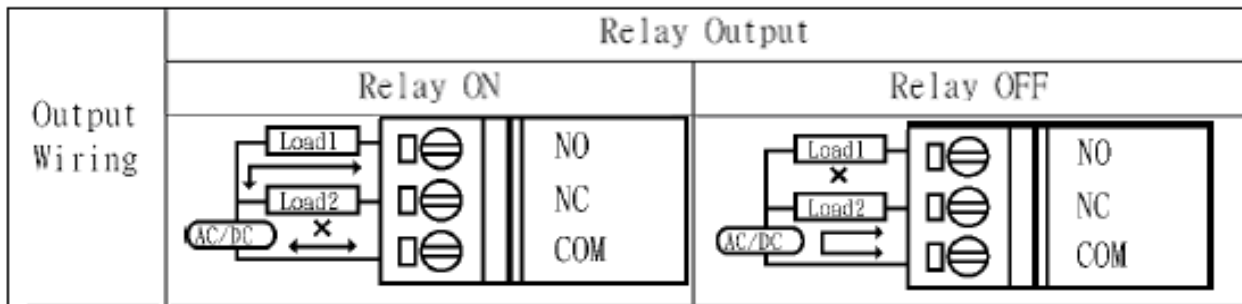
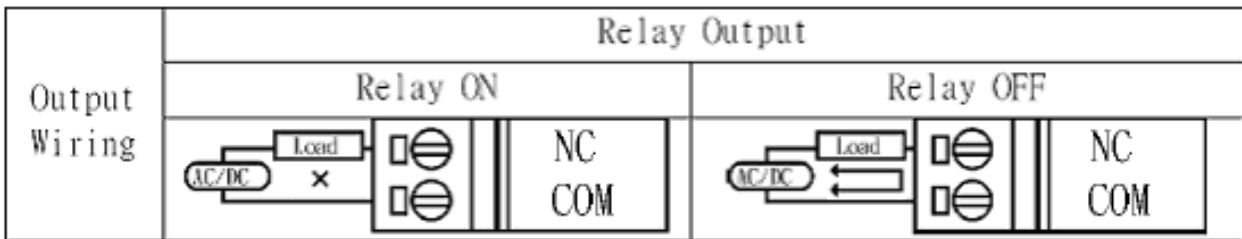
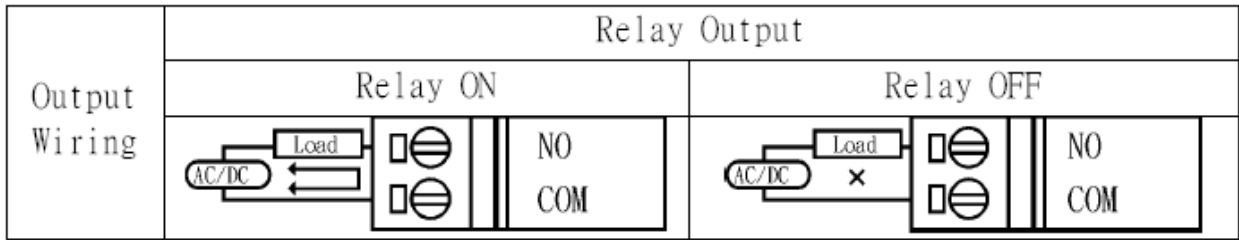

- Digital Input:

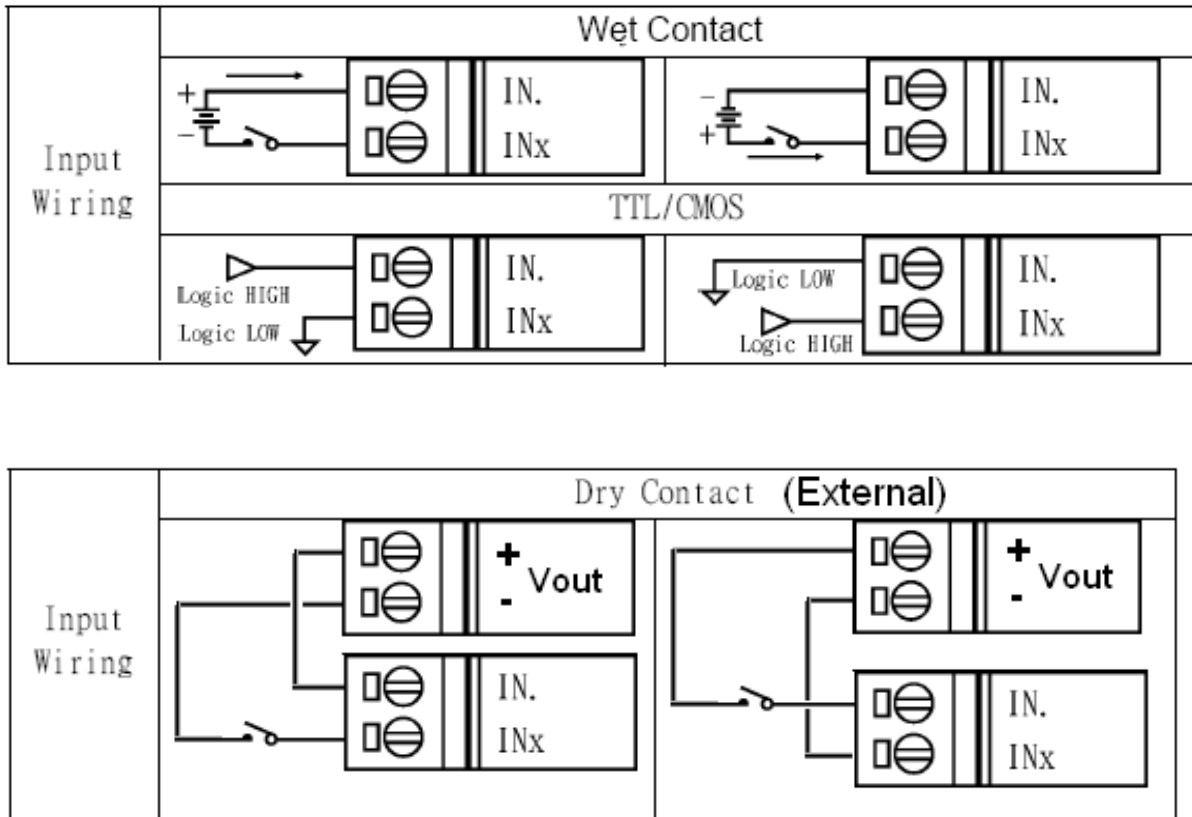

4 EX9132CST-DIO Converter Configuration

4.1

Find out the IP search tool program “EX9132CST.exe(Utility)” to execute. You may have to close the Firewall or AntiVirus program in order to accept it passing through.

4.2

If IP not show up, please press key “F5” to refresh the panel.

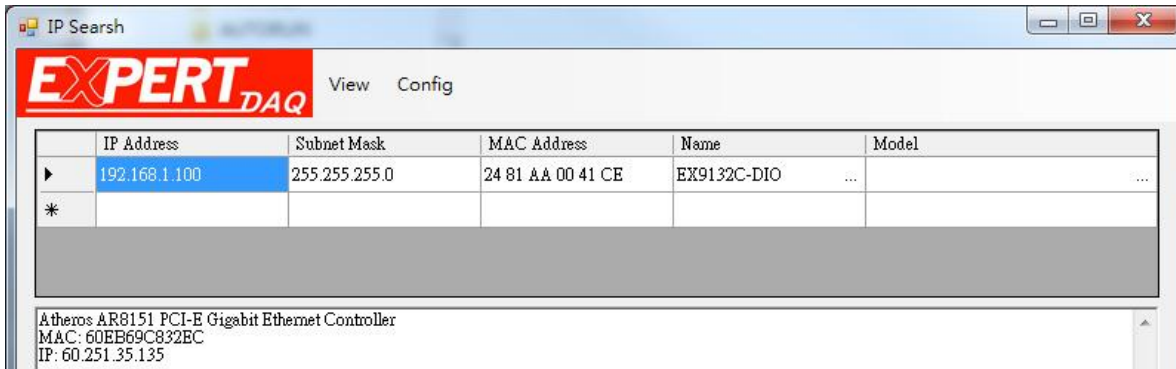

4.3

Ensure PC host and the Converter are in same network segment such as 192.168.1.xxx. If not in same network segment. Following procedure is needed:

4.3.1

Add a new IP address into PC host with network segment same as Converter’s default 192.168.0.xxx or 192.168.1.xxx.

4.3.2

In PC host, click the “Local Area Connection” of Ethernet network.

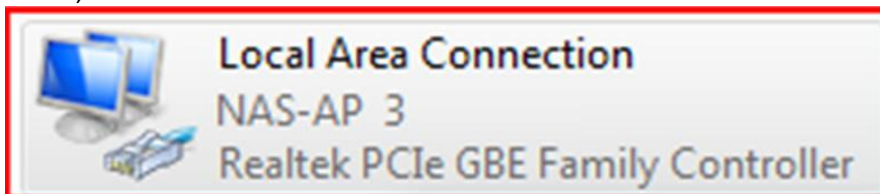

4.3.3

Click the “Properties”

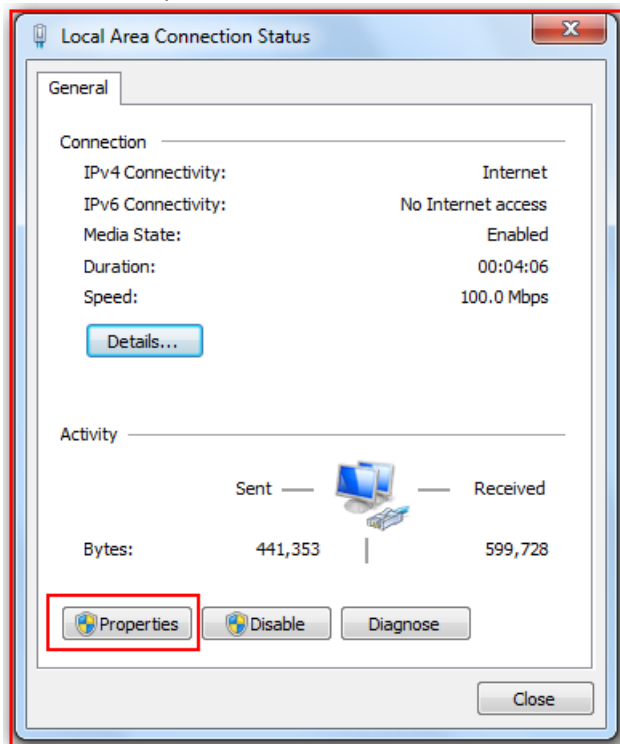

4.3.4

Click the “Internet Protocol(TCP/IPv4)”, and the click ”Properties”

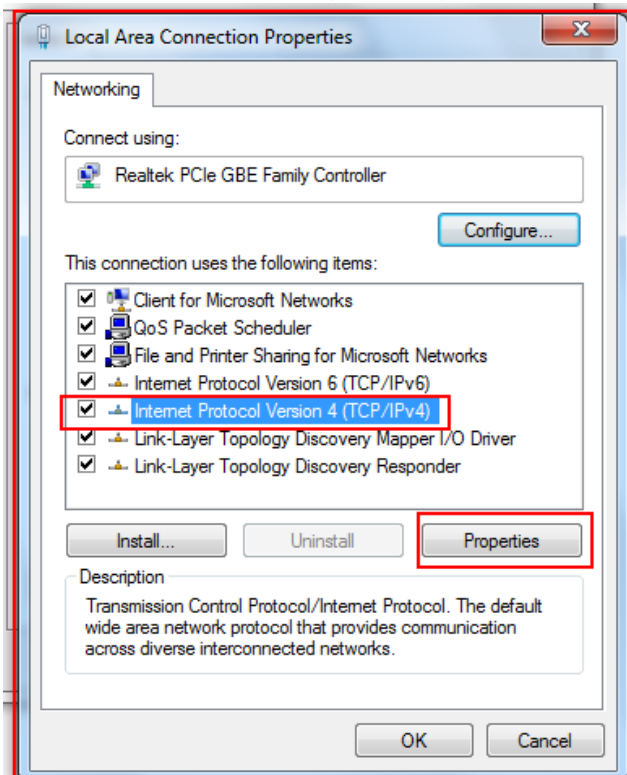

4.3.5

Key in the IP address, subnet mask, default gateway and preferred DNS server. These addresses should be authorized by MIS people.

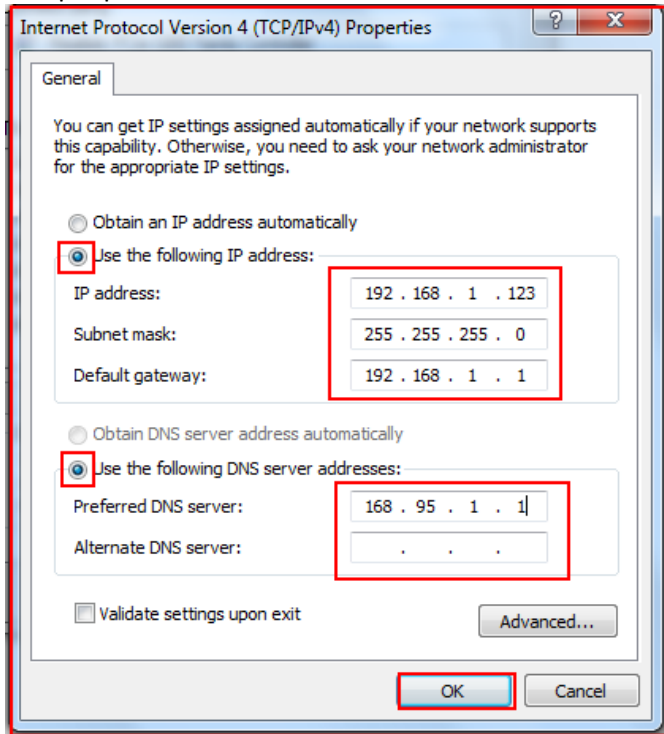

4.4.0

Alternatively, you may choose to change Converter's network segment directly to be same as per PC host. If PC host's network segment is 192.168.0.xxx then please change Converter's IP to 192.168.0.100 (to be authorized by MIS people).

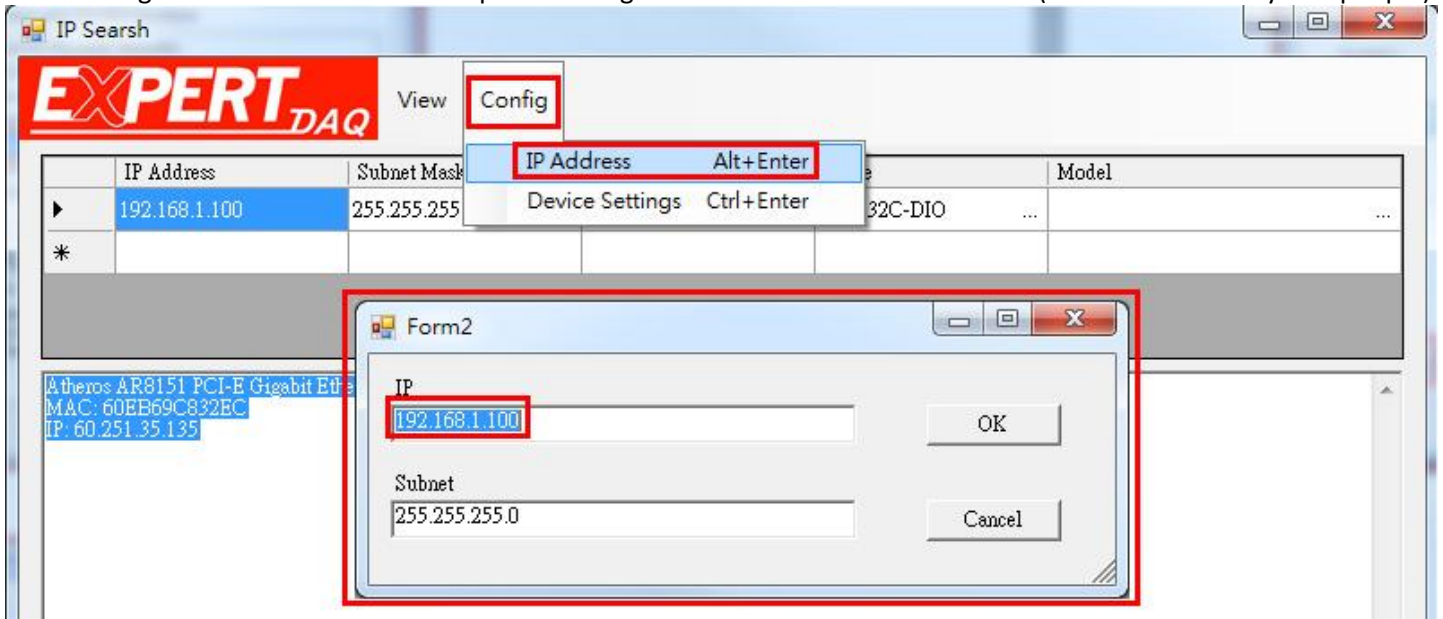

4.5 Configuration

4.5.1

Find out the IP search tool program “EX9132CST.exe(Utility)” to execute.

4.5.2

Click “Config” and “Device Settings”.



4.5.3

Web browser will be opened. Input user name with “admin”, leave the password in blank. Click the “Login” button.

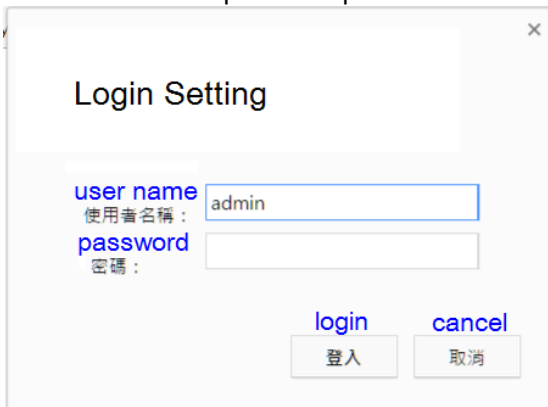

4.5.4

Configuration page will show up

EX9132CST-DIO

Status Network RS232 RS485/422 Digital IO System	Network	
	IP Address	192.168.1.100
	Subnet Mask	255.255.255.0
	Gateway	192.168.1.1
	MAC Address	33-84-CF-8C-9A-4A
	Packets Sent/Received	99/175
	System	
	System Up Time	0/00:00:18
	Firmware Release	2015/11/06 1.1191
	Serial Number	29911020027

4.5.5

Network setup page:

Please ensure address of IP, Subnet Mask, Gateway are correct. Click "Save" to save any change, then a page show up "Back" and "Reboot" button. You may click "back" to set up continually or click "reboot" the device.

EX9132CST-DIO

<ul style="list-style-type: none"> Status Network RS232 RS485/422 Digital IO System 	<div style="background-color: #cccccc; padding: 2px;">Network</div> <table style="width: 100%; border-collapse: collapse;"> <tr> <td style="padding: 5px;">Network Link Speed</td> <td style="padding: 5px;">Auto ▾</td> </tr> <tr> <td style="padding: 5px;">DHCP</td> <td style="padding: 5px;"><input type="checkbox"/> Enable</td> </tr> <tr> <td style="padding: 5px;">IP Address</td> <td style="padding: 5px;"><input style="width: 100%;" type="text" value="192.168.1.100"/></td> </tr> <tr> <td style="padding: 5px;">Subnet Mask</td> <td style="padding: 5px;"><input style="width: 100%;" type="text" value="255.255.255.0"/></td> </tr> <tr> <td style="padding: 5px;">Gateway</td> <td style="padding: 5px;"><input style="width: 100%;" type="text" value="192.168.1.1"/></td> </tr> <tr> <td style="padding: 5px;">DNS Server</td> <td style="padding: 5px;"><input style="width: 100%;" type="text" value="168.95.192.1"/></td> </tr> </table> <div style="text-align: right; margin-top: 10px;"> <input type="button" value="Save"/> </div>	Network Link Speed	Auto ▾	DHCP	<input type="checkbox"/> Enable	IP Address	<input style="width: 100%;" type="text" value="192.168.1.100"/>	Subnet Mask	<input style="width: 100%;" type="text" value="255.255.255.0"/>	Gateway	<input style="width: 100%;" type="text" value="192.168.1.1"/>	DNS Server	<input style="width: 100%;" type="text" value="168.95.192.1"/>
Network Link Speed	Auto ▾												
DHCP	<input type="checkbox"/> Enable												
IP Address	<input style="width: 100%;" type="text" value="192.168.1.100"/>												
Subnet Mask	<input style="width: 100%;" type="text" value="255.255.255.0"/>												
Gateway	<input style="width: 100%;" type="text" value="192.168.1.1"/>												
DNS Server	<input style="width: 100%;" type="text" value="168.95.192.1"/>												

EX9132CST-DIO

<ul style="list-style-type: none"> Status Network RS232 RS485/422 Digital IO System 	<h2 style="margin: 0;">Configuration Updated</h2> <div style="display: flex; justify-content: center; gap: 20px; margin-top: 10px;"> <input type="button" value="Back"/> <input type="button" value="Reboot"/> </div>
--	---

4.5.6

RS-232 setup page:

Assign socket port and the other parameters. Click “Save” to save any change, then a new page show up “Back” and “Reboot” button. Click “back” to set up continually or click “reboot” the device.

EX9132CST-DIO

Status
 Network
 RS232
 RS485/422
 Digital IO
 System

RS232

Socket Port	100	TCP Server ▾	
Baud Rate	115200 ▾	bps	
Parity	None ▾		
Data Bits	8 ▾		
Stop Bits	1 ▾		
Interface	RS232 ▾		
RTS/CTS	<input type="checkbox"/> Hardware flow control		
DSR/DTR	<input type="checkbox"/> Socket status & control		
Packet Mode for UART Input	<input checked="" type="checkbox"/> Enable		
Inactive Timeout	<input checked="" type="checkbox"/> Enable	5	minutes
UART Command	<input type="checkbox"/> Enable		
<input type="button" value="Save"/>			

4.5.7

RS-422/485 setup page:

Assign socket port and the other parameters. Click “Save” to save any change, then a new page show up “Back” and “Reboot” button. Click “back” to set up continually or click “reboot” the device.

EX9132CST-DIO

Status
 Network
 RS232
 RS485/422
 Digital IO
 System

RS485/422

Socket Port	101	TCP Server ▾	
Baud Rate	115200 ▾	bps	
Parity	None ▾		
Data Bits	8 ▾		
Stop Bits	1 ▾		
Interface	RS485 (Half Duplex) ▾		
Packet Mode for UART Input	<input checked="" type="checkbox"/> Enable		
Inactive Timeout	<input checked="" type="checkbox"/> Enable	5	minutes
UART Command	<input type="checkbox"/> Enable		
<input type="button" value="Save"/>			

5 Testing procedure for data transmission

5.1

Open the Hyper Terminal

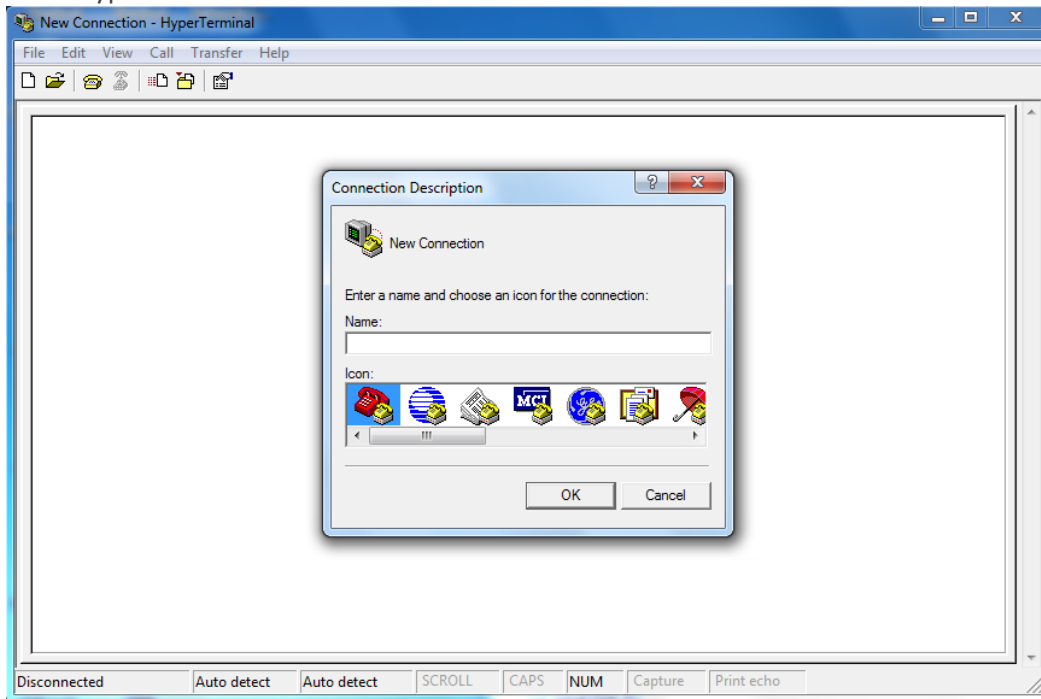

5.2

Key in a file name of connection (ex. test) and then click "OK".

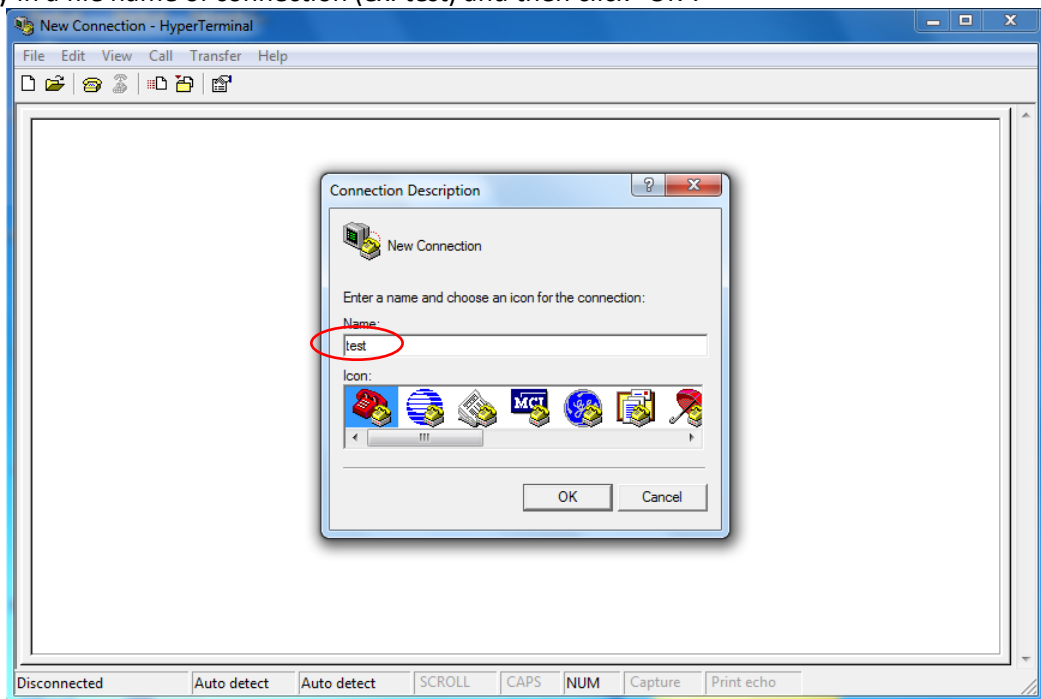

5.3

Choose TCP/IP, then click "OK".

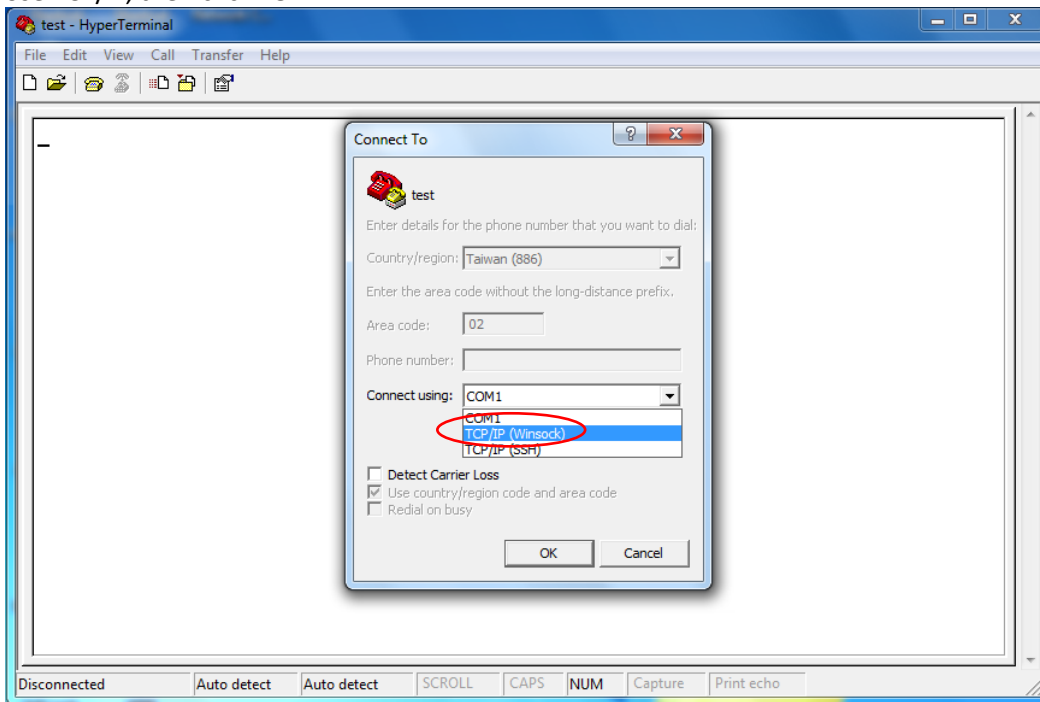

5.4

Key in the Converter's IP address and Socket port then click "OK".

*for testing RS-232: default Port Number is 100

*for testing RS-422/485: default Port number is 101

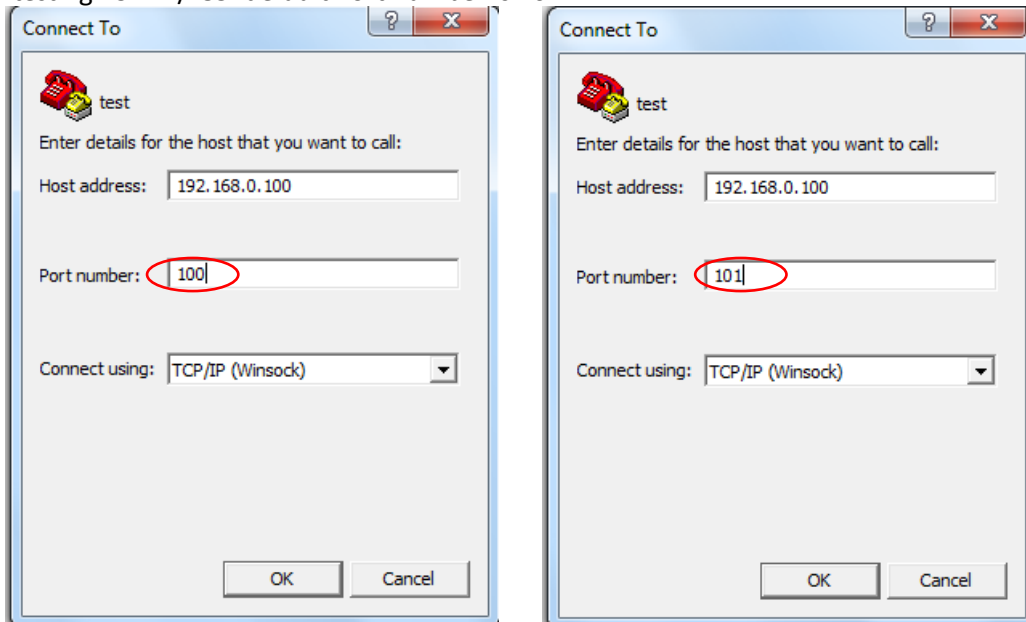

5.5 A HyperTerminal window will show up. The time counter start if connect is correct.

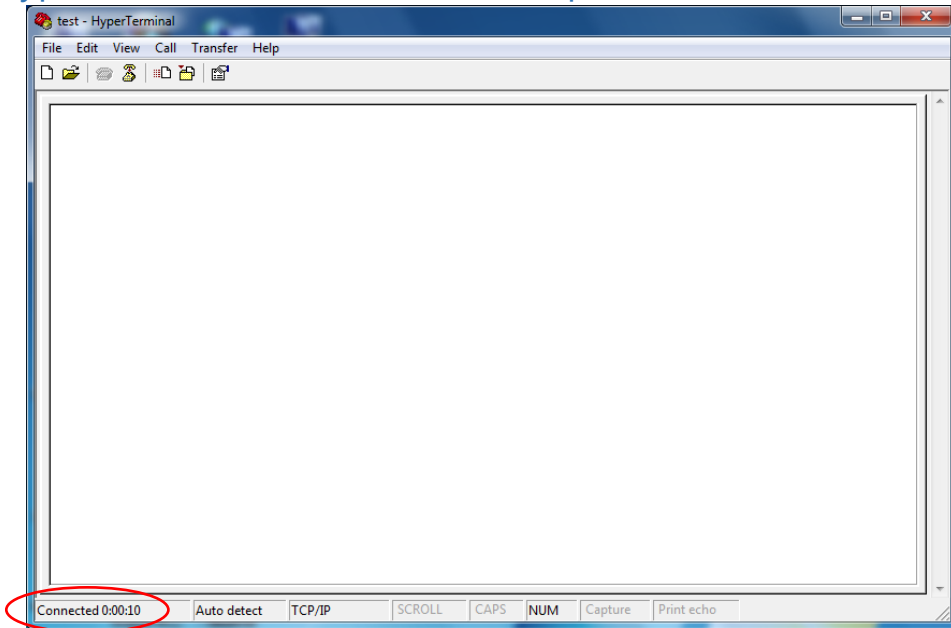

5.6

Echo Loop Test

- For RS-232 testing: Short DB9 connector #2 pin and #3 pin as circuit.
- For RS-422 testing: Short the green Terminal Block T+ to R+ and T- to R- or TX to RX. In RS-422/485 setup page: choose RS422 firstly.

Stop Bits

Interface

Packet Mode for UART Input

Inactive Timeout ites

- Key in any characters. If those characters show on the screen means the loop test is successful.

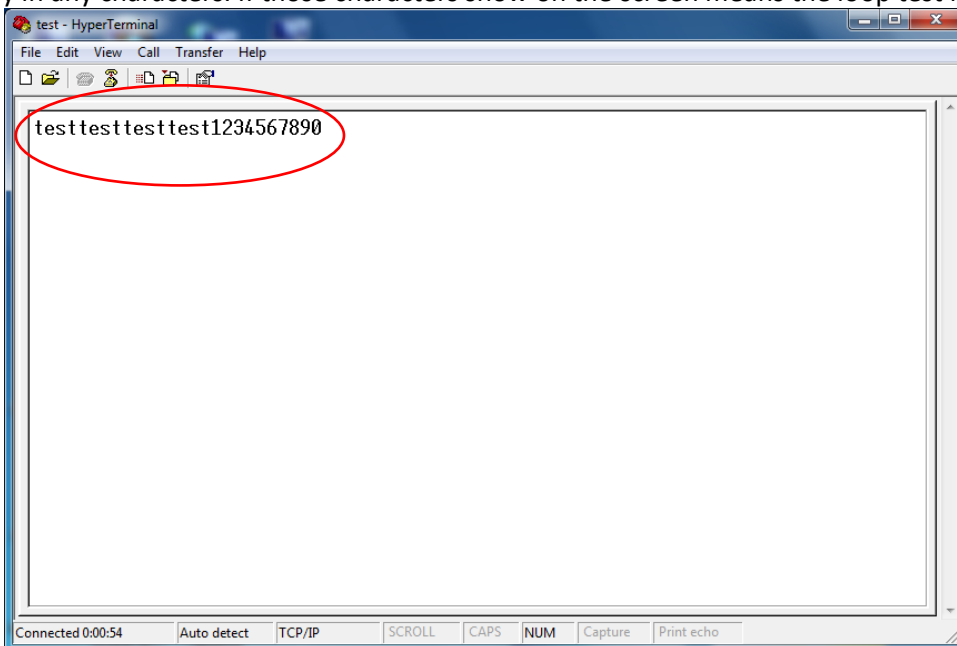

5.7

If not able to type or not seen any character present in the window, please check every step from beginning of this procedure.

5.8

For RS-485 testing: It needs two devices to connect the Terminal Block D+ to D+ and D- to D-.

In RS-422/485 setup page: choose RS485.

Stop Bits	1 ▾
Interface	RS485 (Half Duplex) ▾
Packet Mode for UART Input	RS485 (Half Duplex)
Inactive Timeout	RS422 (Full Duplex) ▾

5.9

Socket ports must be differentiate between two devices.

Status	RS485/422	
Network	Socket Port	101 TCP Server ▾
RS232	Baud Rate	115200 ▾ bps
RS485/422	Parity	None ▾
Digital IO	Data Bits	8 ▾
System	Stop Bits	1 ▾
	Interface	RS485 (Half Duplex) ▾
	Packet Mode for UART Input	RS485 (Half Duplex)
	Inactive Timeout	RS422 (Full Duplex) ▾ites
	UART Command	<input type="checkbox"/> Enable
		Save

	IP Address	Subnet Mask	MAC Address	Name	Model
▶	192.168.1.100	255.255.255.0	24 81 AA 00 41 CE	EX9132C-DIO	...
*	192.168.1.101	255.255.255.0	24 81 AA 00 41 CC	EX9132C-DIO	...

5.10

Run HyperTerminal as per RS-232 or RS-422 for two socket ports. Key in any characters show on the screen of another socket port means the loop test is successful.

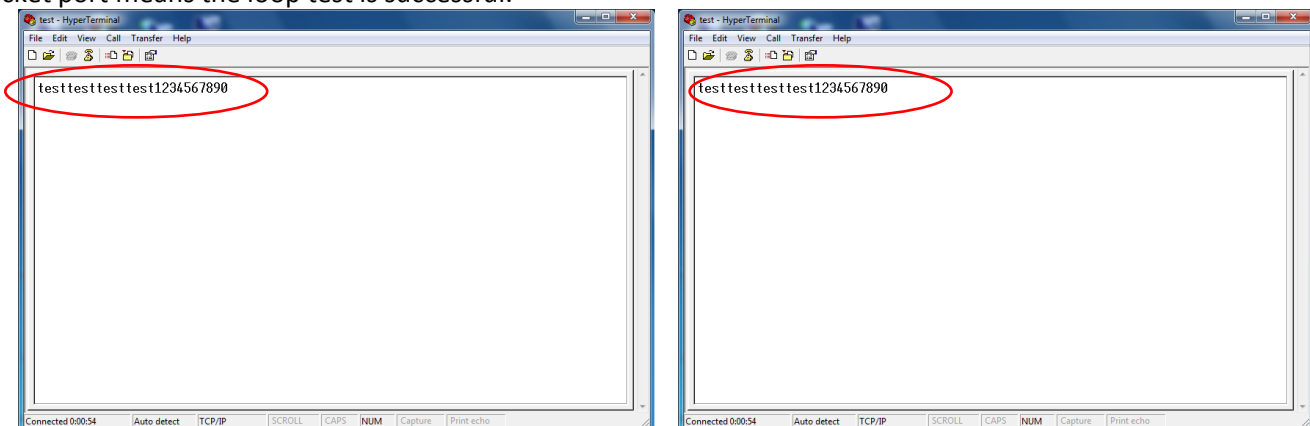

6 Digital Input / Output Status

You can connect to the digital I/O port of socket.

It will return the status of 8 pins of Digital I/O – “00000000”

When you connect the socket port of Digital I/O : 102

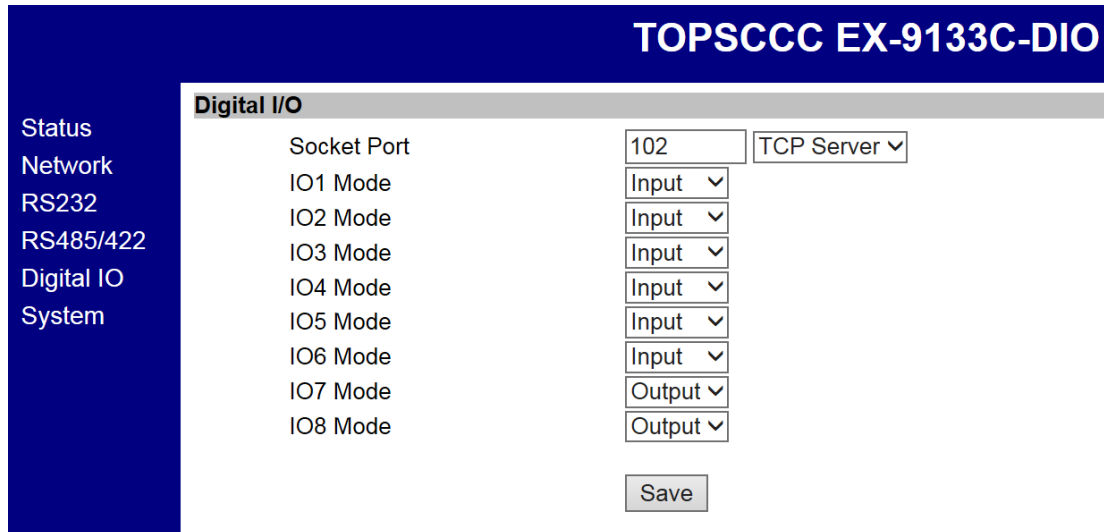

The screenshot shows the 'TOPSCCC EX-9133C-DIO' web interface. On the left is a navigation menu with options: Status, Network, RS232, RS485/422, Digital IO, and System. The 'Digital IO' section is active. The main content area is titled 'Digital I/O' and contains the following configuration options:

Socket Port	102	TCP Server ▾
IO1 Mode	Input ▾	
IO2 Mode	Input ▾	
IO3 Mode	Input ▾	
IO4 Mode	Input ▾	
IO5 Mode	Input ▾	
IO6 Mode	Input ▾	
IO7 Mode	Output ▾	
IO8 Mode	Output ▾	

At the bottom of the configuration area is a 'Save' button.

It will return the status of the TTL Digital I/O ; the default value is “00000000”

TTL Digital I/O total **have** 8 pins ; but the Digital I/O module **are** DO *2 & DI*2

DO-1 is pin 7 ; DO-2 is pin 8 ; DI- 1 is pin 1 ; DI- 2 is pin 2

Digital Output Command set is easier to you,

The default of every pin is “00000000” . it is **active high** for Digital I/O ,

when you want to set DO-1 (PIN 7) active , The command set is “ **071** ”,

“07” mean pin nr.of GPIO, “1” mean active status of Digital I/O pin 7. It will return the value “00000010” from digital I/O socket port.

If you want to change the Digital Output Status to low , The command set is “070 “ , It will return the value “00000000” from digital i/o socket port.

You can use Hyper-Terminal to control DO & monitor DI status :

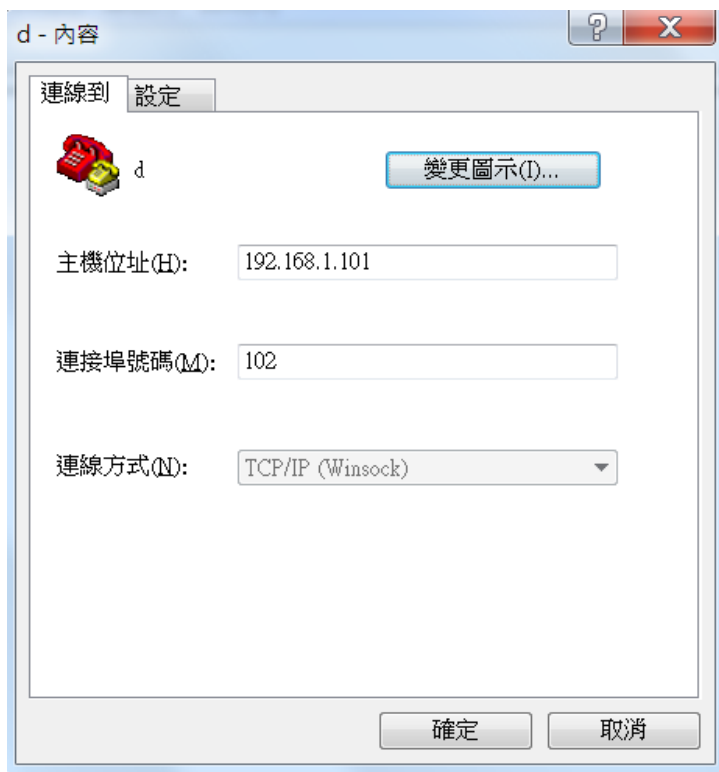

Press Dial-up , converter will response Digital I/O status “00000000” to Host

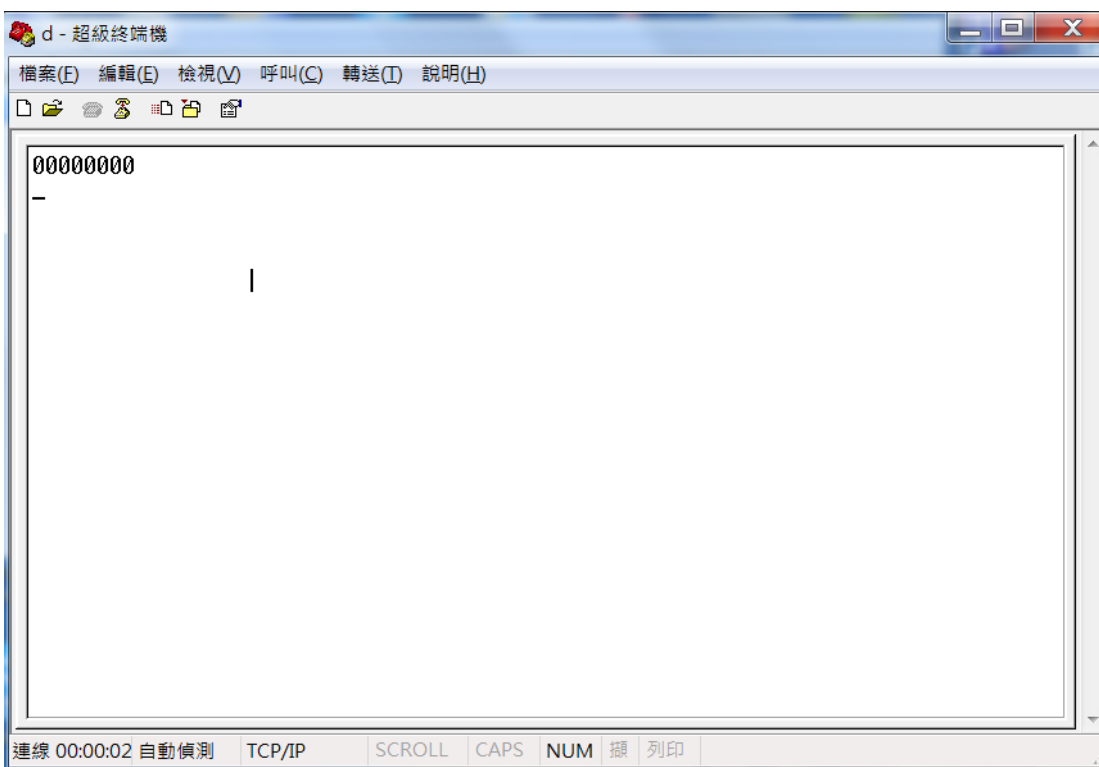

Digital I/O set pin 07 & 08 as Digital Output , set pin 01 &02 as Digital Input

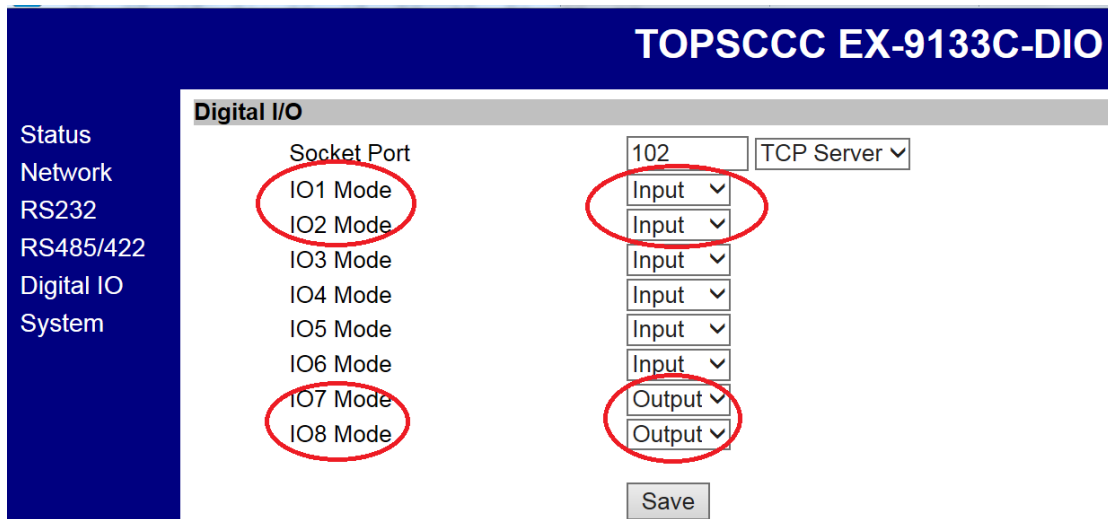

When you want to set DO-1 active , type “071”and press Enter key ,

it will return “00000010” status to Host

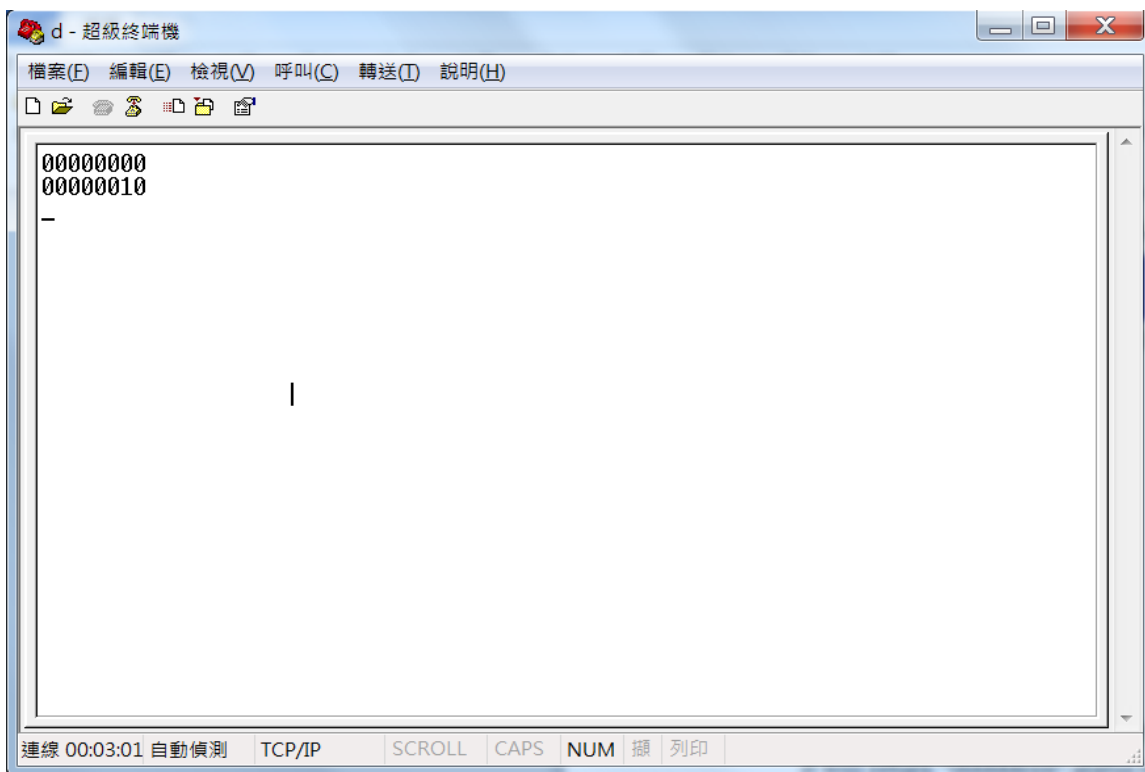

We will set DO-1 link to DI-1 for loop test , when DO-1 active ,DI-1 is active too

Pls see following response.

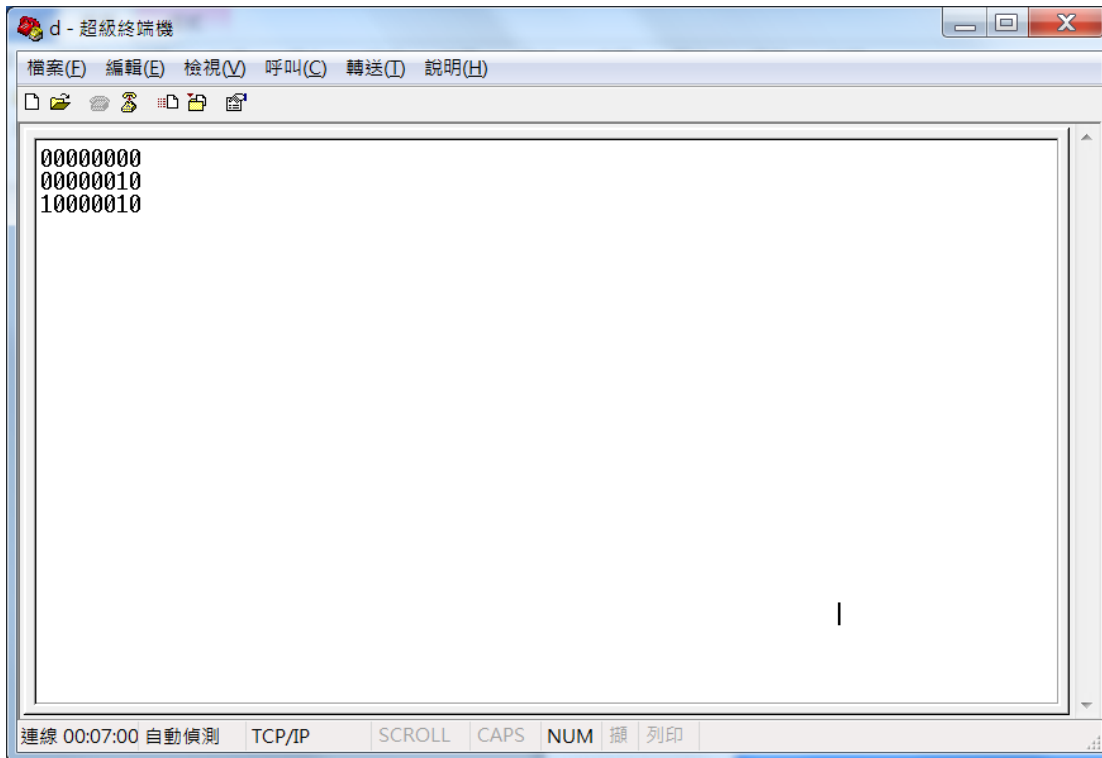

```
d - 超級終端機  
檔案(E) 編輯(E) 檢視(V) 呼叫(C) 轉送(T) 說明(H)  
00000000  
00000010  
10000010  
|  
連線 00:07:00 自動偵測 TCP/IP SCROLL CAPS NUM 擷 列印
```

Set DO-1 to off , type “070”and press enter key , it will return “00000000” status to Host , Due to DI-1 is link to DO-1 , DO-1 off , DI-1 is off too.

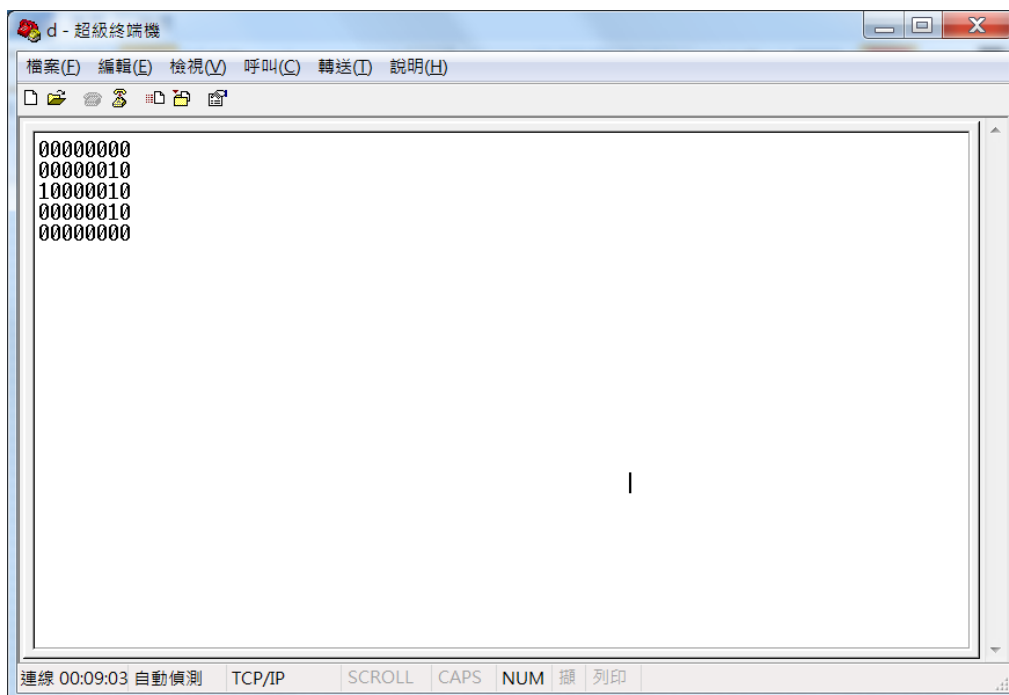

```
d - 超級終端機  
檔案(E) 編輯(E) 檢視(V) 呼叫(C) 轉送(T) 說明(H)  
00000000  
00000010  
10000010  
00000010  
00000000  
|  
連線 00:09:03 自動偵測 TCP/IP SCROLL CAPS NUM 擷 列印
```

7 Appendix A (FAQ)

Q. Why can't the EX9132CST.exe detect the converter on the network?

A. Please check

- if the power is properly plugged to the converter.
- if the network cable is properly connected between the converter and the Hub.

Please refer to the "Hardware Installation" steps in Chapter 2.

Q. Why can't I use IE to setup the converter?

A. Please check if the network domain of your PC is the same as that of the converter.

7.1 Appendix B

Pin outs and Cable Wiring

- DC-In Jack



- RJ-45 Pin Assignment

RJ45 Port

Pin	Signal
1	Tx+
2	Tx-
3	Rx+
6	Rx-

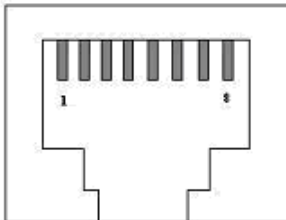

- RS-232 Pin Assignment

The pin assignment scheme for a 9-pin male connector on a DTE is given below.

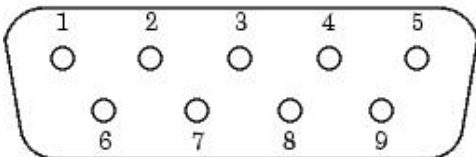

PIN 1 : N/A	PIN 2 : RXD	PIN 3 : TXD	PIN 4 : DTR	PIN 5 : GND
	PIN 6 : DSR	PIN 7 : RTS	PIN 8 : CTS	PIN 9 : N/A

- **RS-485 Pin Assignment**

The pin assignment scheme for a 2-pin RS-485 is given below.

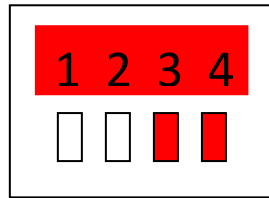

PIN 3 : D+ PIN 4 : D-

- **RS-422 Pin Assignment**

The pin assignment scheme for a 4-pin RS-422 is given below.

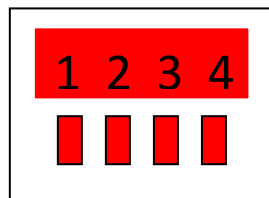

PIN 1 : T+ PIN 2 : T- PIN 3 : R+ PIN 4 : R-

- **DIO Pin Assignment**

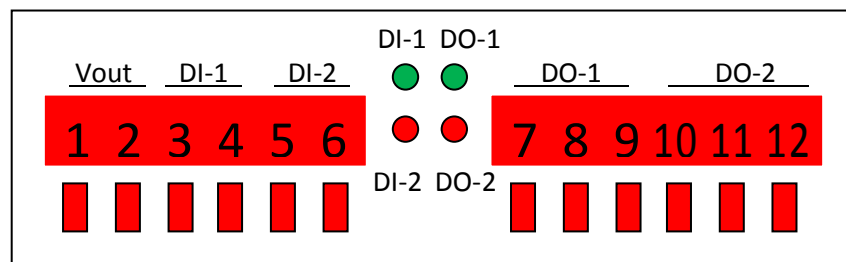

Vout PIN 1 : V- PIN 2 : V+

DI-1 PIN 3 : DI_1- PIN 4 : DI_1+

DI-2 PIN 5 : DI_2+ PIN 6 : DI_2-

DO-1 PIN 7 : DO_1_NO PIN 8 : DO_1_C PIN 9 : DO1_1_NC

DO-2 PIN 10 : DO_1_NO PIN 11 : DO_1_C PIN 12 : DO1_1_NC

•