



ADLINK
TECHNOLOGY INC.

PCIe-GIE7x Series

**PCIe-GIE72/PCIe-GIE72 Pro/
PCIe-GIE74/PCIe-GIE74 Pro**

2/4CH PCI Express®
GigE Vision PoE+ Frame Grabber

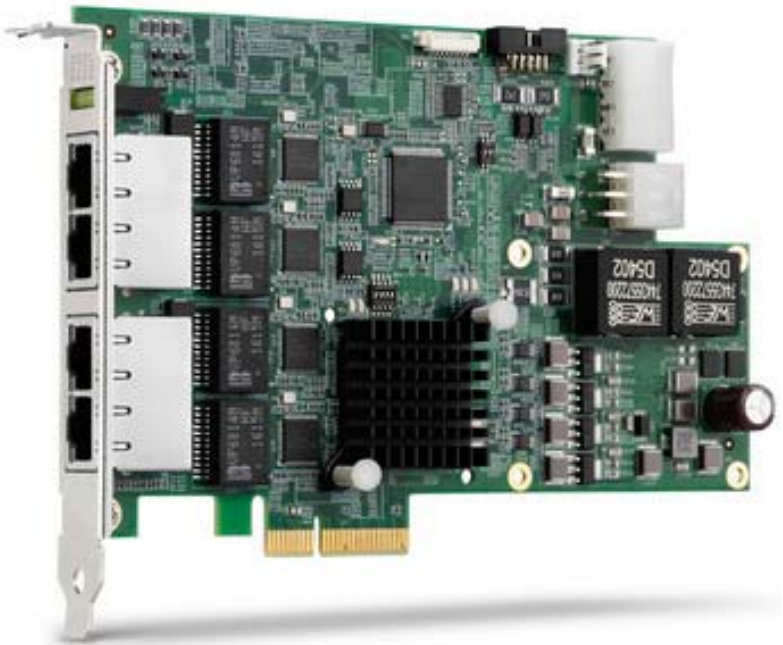

Manual Rev.: 2.00
Revision Date: Oct. 26, 2016
Part No: 50-11177-2000

Advance Technologies; Automate the World.

Revision History

Revision	Release Date	Description of Change(s)
2.00	Oct. 26, 2016	Initial release

Preface

Copyright 2016 ADLINK Technology, Inc.

This document contains proprietary information protected by copyright. All rights are reserved. No part of this manual may be reproduced by any mechanical, electronic, or other means in any form without prior written permission of the manufacturer.

Disclaimer

The information in this document is subject to change without prior notice in order to improve reliability, design, and function and does not represent a commitment on the part of the manufacturer.

In no event will the manufacturer be liable for direct, indirect, special, incidental, or consequential damages arising out of the use or inability to use the product or documentation, even if advised of the possibility of such damages.

Environmental Responsibility

ADLINK is committed to fulfill its social responsibility to global environmental preservation through compliance with the European Union's Restriction of Hazardous Substances (RoHS) directive and Waste Electrical and Electronic Equipment (WEEE) directive. Environmental protection is a top priority for ADLINK. We have enforced measures to ensure that our products, manufacturing processes, components, and raw materials have as little impact on the environment as possible. When products are at their end of life, our customers are encouraged to dispose of them in accordance with the product disposal and/or recovery programs prescribed by their nation or company.

Trademarks

Product names mentioned herein are used for identification purposes only and may be trademarks and/or registered trademarks of their respective companies.

Conventions

Take note of the following conventions used throughout this manual to make sure that users perform certain tasks and instructions properly.



NOTE:

Additional information, aids, and tips that help users perform tasks.



CAUTION:

Information to prevent **minor** physical injury, component damage, data loss, and/or program corruption when trying to complete a task.



WARNING:

Information to prevent **serious** physical injury, component damage, data loss, and/or program corruption when trying to complete a specific task.

Table of Contents

Revision History	ii
Preface	iii
List of Figures	vii
List of Tables	ix
1 Introduction	1
1.1 Overview.....	1
1.2 Features.....	2
1.3 Applications	2
1.4 Specifications.....	3
1.4.1 Power over Ethernet.....	5
1.4.2 PoE vs. PoE+	5
1.4.3 PoE Protection.....	6
1.4.4 PoE Power Management.....	7
1.5 Layout, I/O and Indicators.....	10
1.5.1 PCIe-GIE74/PCIe-GIE74 Pro	10
1.5.2 PCIe-GIE72/PCIe-GIE72 Pro	13
1.5.3 RJ-45 Ethernet Port.....	16
1.5.4 PoE Status LEDs.....	17
1.5.5 4 Pin 12V Power Connector (CN3).....	18
1.5.6 6 Pin 12V Power Connector (CN4).....	19
1.5.7 Card ID Switch (SW1)	19
1.5.8 PoE Switch (SW3)	20
2 Getting Started	23
2.1 Unpacking Checklist	23
2.2 Installation.....	24



Important Safety Instructions..... 25

Getting Service 29

List of Figures

Figure 1-1: PCIe-GIE74/PCIe-GIE74 Pro PCB Top Layout	10
Figure 1-2: PCIe-GIE74/PCIe-GIE74 Pro PCB Underside Layout...	11
Figure 1-3: PCIe-GIE74/PCIe-GIE74 Pro Side View	11
Figure 1-4: PCIe-GIE74/PCIe-GIE74 Pro I/O.....	12
Figure 1-5: PCIe-GIE72/PCIe-GIE72 Pro PCB Top Layout	13
Figure 1-6: PCIe-GIE72/PCIe-GIE72 Pro PCB Underside Layout...	13
Figure 1-7: PCIe-GIE72/PCIe-GIE72 Pro Side View	14
Figure 1-8: PCIe-GIE72/PCIe-GIE72 Pro I/O.....	15
Figure 1-9: RJ-45 Ethernet Connector	16
Figure 1-10: Status LEDs.....	17
Figure 1-11: 4 Pin 12V Power Connector	18
Figure 1-12: 6 Pin 12V Power Connector	19
Figure 1-13: Card ID Switch.....	19
Figure 1-14: PoE Switch	20

This page intentionally left blank.

List of Tables

Table 1-1: PoE and PoE+ Parameters	5
Table 1-2: Over- and Undervoltage Protection Parameters.....	6
Table 1-3: Icut Per PoE class	6
Table 1-4: Overtemperature Protection (OTP) Parameters.....	7
Table 1-5: Available Power per PoE Class.....	8
Table 1-6: PoE Port Priority	8
Table 1-7: PoE Power Budget	9
Table 1-8: PCIe-GIE74/PCIe-GIE74 Pro PCB Layout Legend	11
Table 1-9: PCIe-GIE72/PCIe-GIE72 Pro PCB Layout Legend	14
Table 1-10: RJ-45 Ethernet Port Connector Signals.....	16
Table 1-11: RJ-45 Ethernet Port LED Indicators	17
Table 1-12: 4 Pin 12V Power Connector Pin Assignment	18
Table 1-13: 6 Pin 12V Power Connector Pin Assignment	19
Table 1-14: Card ID Switch Settings.....	19
Table 1-15: Card ID Switch Legend.....	20
Table 1-16: PoE Switch Settings	21

This page intentionally left blank.

1 Introduction

1.1 Overview

ADLINK's PCIe-GIE7x Series features PCI Express® x4 lane GigE Vision PoE+ (Power Over Ethernet Plus, IEEE 802.3at) frame grabbers supporting 2/4CH independent Gigabit Ethernet ports for multiple GigE Vision connections with data transfer up to 1 Gb/s per port.

The PCIe-GIE7x's PoE+ offers up to 30W PoE power and automatic detection for stable and reliable connection between PoE, PoE+, or non-PoE cameras and frame grabbers, reducing costs, simplifying installation, and easing maintenance burdens. The series further enhances PoE protection to protect against under-voltage, overvoltage, overcurrent, and overheating, programmable to not only switch PoE on and off, but also monitor PoE power consumption and automatically manage power budget according to the power source (PCIe or 4/6 pin Molex connector). Available power is directed to higher priority ports if a situation arises in which there is insufficient power for all PoE ports.

The PCIe-GIE72/74, in Pro configuration, fulfills even more application requirements with software license management integrating a Licensed Security EEPROM for third party software, eliminating the need for secure license dongles or other hardware, providing SDK and utilities to license software safely and easily. As well, ToE (Trigger over Ethernet) transmits trigger commands via Ethernet for full synchronization of multi-camera acquisition.

1.2 Features

- ▶ PCI Express® x4 compliant
- ▶ Supports 2/4 independent Gigabit Ethernet ports
- ▶ IEEE 802.3at for PoE+ (Power over Ethernet Plus) 50 to 57V, 30W per port
- ▶ Up to 20/61.6/120W PoE power supply from PCIe bus or 4-pin/6-pin Molex connector
- ▶ Powered Device (PD) auto detection and classification
- ▶ Link Aggregation/jumbo frame (9 Kb)
- ▶ LED connectivity indicators
- ▶ IEEE 1588 (PTP technology, hardware only)
- ▶ Multiple card and camera support
- ▶ PoE protection from protect against undervoltage, overvoltage, overcurrent, and overheating
- ▶ PoE power management, programmable PoE on/off, monitoring POE power consumption and POE budget and priority control
- ▶ ToE (Trigger over Ethernet) (Pro only)
- ▶ License management (Pro only)
- ▶ Windows® 7/8.1/10 OS compatible
- ▶ C#, VB.NET/VC++ compatible

1.3 Applications

The PCIe-GIE7x Series is ideally suited to frame grab functions in a wide variety of applications, including:

- ▶ Machine Vision Inspection systems
- ▶ Scientific research instrumentation
- ▶ Medical research instrumentation



NOTE:

The PCIe-GIE7x Series Function Library Reference can be downloaded from the product's pages at <http://www.adlink-tech.com>



NOTE:

Support for total PoE power up to 120W is only available on the PCIe-GIE74 Pro

1.4 Specifications

	PCIe-GIE72	PCIe-GIE72 Pro	PCIe-GIE74	PCIe-GIE74 Pro
PCI Express				
PCIe X4 ports	PCIe v2.1 (2.5 GT/s) 1 slot			
Differential Output Peak to Peak Voltage	+0.8V to +1.2V			
Differential Input Peak to Peak Voltage	+0.175V to +1.2V			
Input voltage for PERST#, WAKE#, and SMBus	-0.75V to +4.05V			
Gigabit Ethernet				
LAN Chip	Intel® I210, PCIe v2.1 (2.5GT/s)			
Gigabit Ethernet Ports	2/4			
PoE Signal				
Max Output Power	PoE+, Power over Ethernet plus, 30W per port, IEEE 802.3at compliant			
PoE Output Voltage	50 to 57V, PoE port positive voltage feed			

	PCIe-GIE72	PCIe-GIE72 Pro	PCIe-GIE74	PCIe-GIE74 Pro
Physical				
Dimensions	167.6 W x 106.6 H mm (6.6 x 4.2 in.)			
Operating Temperature	<ul style="list-style-type: none"> ▶ 0°C to 70°C when PoE power is 20W and 61.6W ▶ 0°C to 40°C when PoE power is 120W 			
Storage Temperature	-40°C to 85°C			
Safety Compliance	CE/FCC Class B; RoHS			
Advanced				
Jumbo Frame	9 KB			
IEEE 1588 (Hardware Only)	Yes			
Link Aggregation	Yes			
Multiple cards	Yes			
PoE+, Power over Ethernet Plus, IEEE 802.3at	Yes			
PoE Protection	Yes			
PoE Power Management	Yes			
License Management	No	Yes	No	Yes
ToE, Trigger over Ethernet	No	Yes	No	Yes
Power Requirements				
Input Voltage	3.3VDC and 12VDC, (w/ PC system power)			
PoE Power w/ PCIe Slot	Max. 20W (+12V@2.1A)			

	PCIe-GIE72	PCIe-GIE72 Pro	PCIe-GIE74	PCIe-GIE74 Pro
PoE Power w/ Molex Connector	Max 61.6W for 4-pin (+12V@6A) or 6-pin (+12V@6A)			Max 120W for both 4-pin (+12V@6A) and 6-pin (+12V@6A)

1.4.1 Power over Ethernet

The PCIe-GIE7x Series' PoE (Power over Ethernet) specification enables the PCIe-GIE7x to act as power sourcing equipment (PSE), providing power through a twisted-pair Ethernet connection to a powered device (PD), such as a GigE Vision camera, IP phone, or wireless access points.

1.4.2 PoE vs. PoE+

Power over Ethernet (PoE), based on the IEEE 802.3af standard, delivers power over Ethernet up to 15.4W per port, and Power over Ethernet Plus (PoE+), based on IEEE 802.3at, up to 30W per port.

The PXIe-GIE7x Series supports both PoE and PoE+, automatically detecting which is supported by devices upon connection and supporting the requisite protocol.

	PoE (IEEE 802.3af)	PoE+ (IEEE 802.3at)
Power available at PD	12.95W	25.5W
Maximum power from PSE	15.4W	30.0W
Voltage range (at PSE)	44.0 to 57.0 V	50.0 to 57.0 V
Voltage range (at PD)	37.0 to 57.0 V	42.5 to 57.0 V
Maximum current	350 mA/mode	600 mA/mode

Table 1-1: PoE and PoE+ Parameters

1.4.3 PoE Protection

The PCIe-GIE7x provides PoE protection from undervoltage, over-voltage, overcurrent, overheating, and budget overages.

Under- and Overvoltage

PoE output is monitored and power supply to the PD interrupted when any output exceeds OVP (Over Voltage Protection) or falls below UVP (Under Voltage Protection) limits.

Normal PoE	50 to 57V
UVP	29V
OVP	62V

Table 1-2: Over- and Undervoltage Protection Parameters

Overcurrent Protection

Overcurrent defines a condition in which the current (in amperes) exceeds a rated value, or ICUT, caused by overload, short circuit, or ground fault. The PCIe-GIE7x protects the circuit by shutting down connection to the PD when the current achieves a value that can generate excessive or dangerous temperature rise in conductors.

Class	ICUT
Class 1	112mA +/- 5%
Class 2	206mA +/- 5%
Class 3 or Class 0	375mA +/- 5%
Class 4	638mA +/- 5%

Table 1-3: Icut Per PoE class

Overtemperature Protection

Two trigger temperatures, HT (High Temperature) and LT (Low Temperature) respectively can be preset. When HT is reached, the PCIe-GIE7x automatically shuts down PoE power until the temperature sensor falls below LT.

While default values of HT and LT are 130°C and 90°C respectively, they can be changed via PoE Power Management SDK or Utility, with available range of HT 80 to 130°C, and LT 70 to 120°C.

	HT	LT
Default Value	130°C	90°C
Range	80 to 130°C	70 to 120°C

Table 1-4: Overtemperature Protection (OTP) Parameters

1.4.4 PoE Power Management

PoE device reliability is greatly enhanced with:

- ▶ Programmable PoE-based on/off switching for each port
- ▶ PoE power budget management based on power source, with monitoring and reporting of Total Power Budget, Reserved Power, Remaining Unused Budget, and Current Power Usage
- ▶ PoE status monitor including PoE classification and voltage/current for each port
- ▶ PoE port priority of Port1/Port2/Port3/Port4
- ▶ PCIe-GIE7x Series board information Including available devices, PoE switch (SW3) status, board temperature, and firmware and MCU versions

PoE Classification

Available power for the PCIe-GIE7x Series is as shown. If PCIe-GIE7x detects no classification of PD, default Class 0 power level is provided.



NOTE:

Due to inherent cable resistance, voltage drops along the length of the cable result in power loss to the remote PD. For example, although the PCIe-GIE7x, upon detection of a Class 3 device, provides up to 15.4W of power, on a full 100m cable, a maximum of only 12.95W will be available to the remote PD.

Power Class	0	1	2	3	4
PSE Power over PoE	15.4W	4.0W	7.0W	15.4W	N/A
PSE Power over PoE+	15.4W	4.0W	7.0W	15.4W	30.0W

Table 1-5: Available Power per PoE Class

PoE Port Priority

PoE port priority, as shown, is fixed. Available power is diverted to the priority ports if insufficient power is available to all PoE ports.

	Priority
Port 1	1
Port 2	2
Port 3	3
Port 4	4

Table 1-6: PoE Port Priority

PoE Power Budget

The PCIe-GIE7x Series automatically manages power budget according to power source (PCIe or 4/6 pin Molex connector). When budget is exceeded, PoE power is interrupted to prevent damage to the PCIe-GIE7x and connected devices.

PoE Power Source	PCIe slot	4-pin 12V connector	6-pin 12V connector	4-pin 12V connector/ 6-pin 12V connector
Budget	20W	61.6W	61.6W	120W (PCIe-GIE74 Pro only)

Table 1-7: PoE Power Budget

Power Management SDK and Utility

The ADLINK Power Management SDK and Utility are standard and ready to use with the PCIe-GIE7x Series, with no additional licensing required. Applications are easily created with the SDK, requiring only a few lines of code. The Power Management Utility is an interactive Windows application for PoE configuration and status monitoring.

1.5 Layout, I/O and Indicators



All dimensions shown are in mm

NOTE:

1.5.1 PCIe-GIE74/PCIe-GIE74 Pro

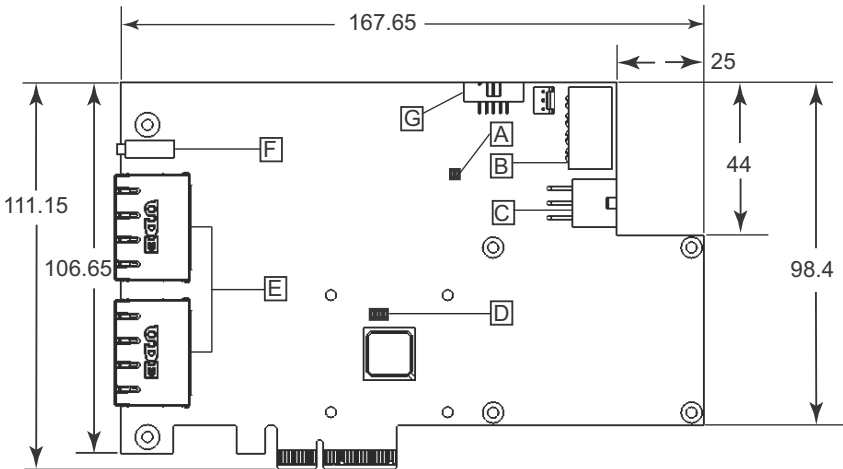

Figure 1-1: PCIe-GIE74/PCIe-GIE74 Pro PCB Top Layout

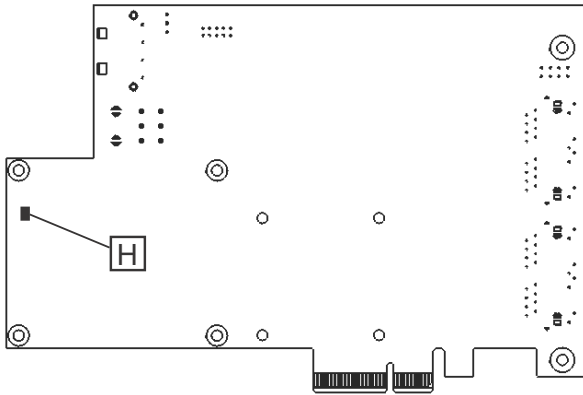

Figure 1-2: PCIe-GIE74/PCIe-GIE74 Pro PCB Underside Layout

A	POE switch (SW3)
B	4-pin 12V connector
C	6-pin 12V connector
D	Card ID switch (SW1)
E	RJ45 connectors x2
F	POE LED
G	Trigger In connector
H	Temperature sensor

Table 1-8: PCIe-GIE74/PCIe-GIE74 Pro PCB Layout Legend

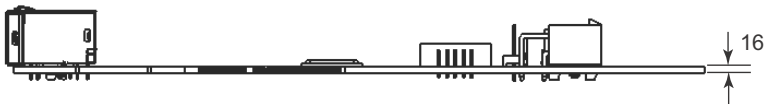

Figure 1-3: PCIe-GIE74/PCIe-GIE74 Pro Side View

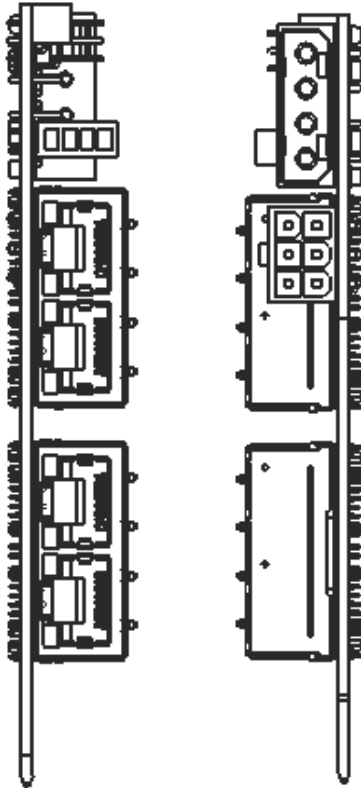

Figure 1-4: PCIe-GIE74/PCIe-GIE74 Pro I/O

1.5.2 PCIe-GIE72/PCIe-GIE72 Pro

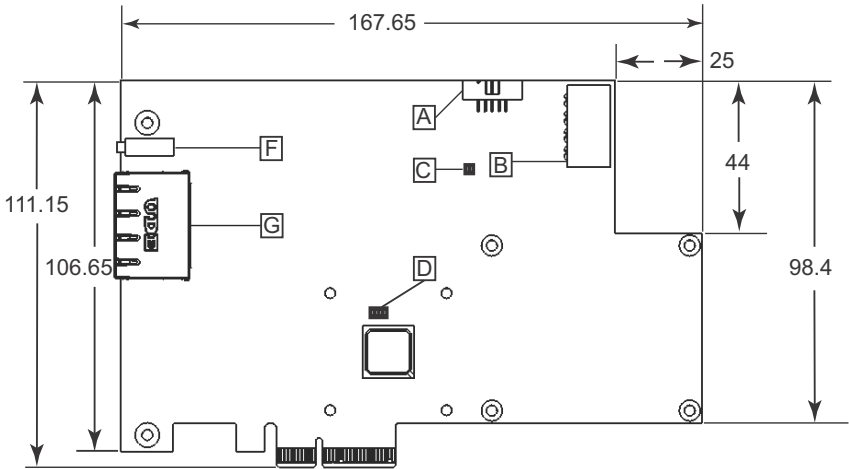

Figure 1-5: PCIe-GIE72/PCIe-GIE72 Pro PCB Top Layout

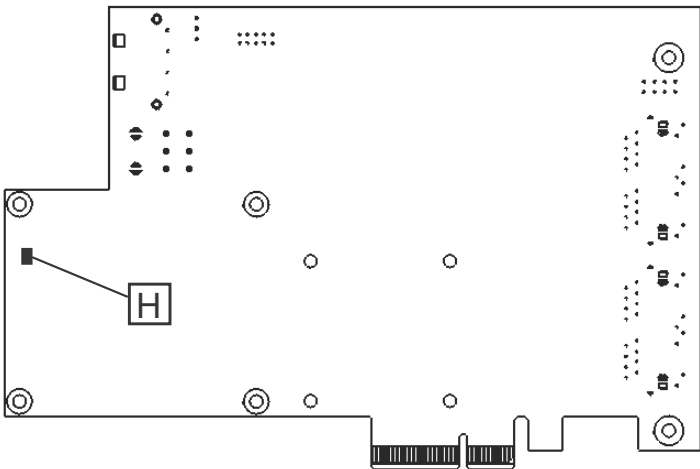

Figure 1-6: PCIe-GIE72/PCIe-GIE72 Pro PCB Underside Layout

A	Trigger In connector
B	4-pin 12V connector
C	POE switch (SW3)
D	Card ID switch (SW1)
E	RJ45 connector
F	POE LED
G	Temperature sensor

Table 1-9: PCIe-GIE72/PCIe-GIE72 Pro PCB Layout Legend

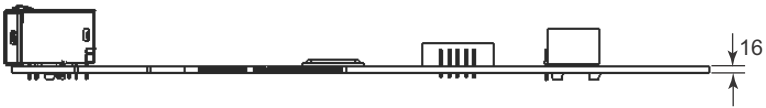

Figure 1-7: PCIe-GIE72/PCIe-GIE72 Pro Side View

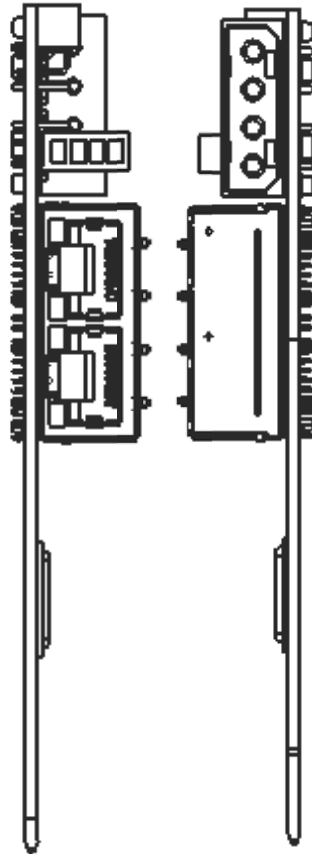

Figure 1-8: PCIe-GIE72/PCIe-GIE72 Pro I/O

1.5.3 RJ-45 Ethernet Port

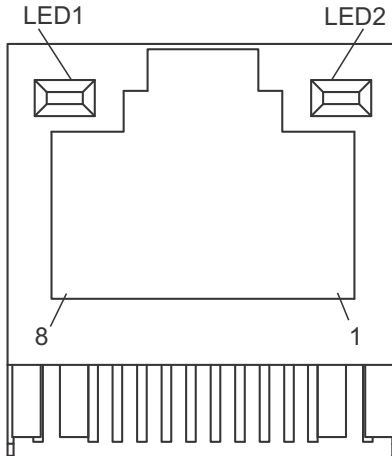

Figure 1-9: RJ-45 Ethernet Connector

Pin	Signal
1	MDI0+ (PoE_DCV+)
2	MDI0- (PoE_DCV+)
3	MDI1+ (PoE_DCV-)
4	MDI2+ (PoE_DCV+)
5	MDI2- (PoE_DCV+)
6	MDI1- (PoE_DCV-)
7	MDI3+ (PoE_DCV-)
8	MDI3- (PoE_DCV-)

Table 1-10: RJ-45 Ethernet Port Connector Signals

	Activity	Status
LED1 10/100/1000	Off	10 Mbps
	Green	100Mbps
	Yellow	1000Mbps
LED2 ACT/LINK	Off	No link
	Green	Linked
	Flashing green	Data activity

Table 1-11: RJ-45 Ethernet Port LED Indicators

1.5.4 PoE Status LEDs

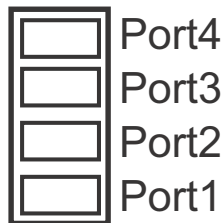

Figure 1-10: Status LEDs

Four yellow LEDs, when lit, indicate PoE activity for the respectively labeled port.

1.5.5 4 Pin 12V Power Connector (CN3)

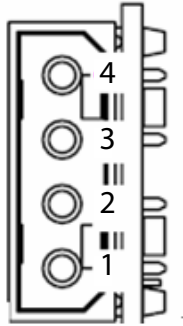

Figure 1-11: 4 Pin 12V Power Connector

Pin	Signal
1	+12V
2	GND
3	GND
4	+5

Table 1-12: 4 Pin 12V Power Connector Pin Assignment

1.5.6 6 Pin 12V Power Connector (CN4)

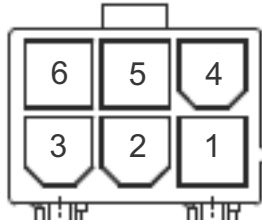

Figure 1-12: 6 Pin 12V Power Connector

Pin	Signal	Pin	Signal
1	+12V	4	+5
2	GND	5	Sense
3	GND	6	GND

Table 1-13: 6 Pin 12V Power Connector Pin Assignment

1.5.7 Card ID Switch (SW1)

Card ID default setting is 15 (0x1111).

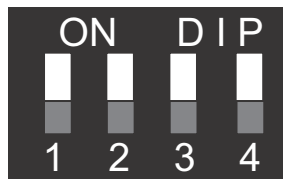

Figure 1-13: Card ID Switch

	Definition
ON	1 (Default)
OFF	0

Table 1-14: Card ID Switch Settings

Card ID	1	2	3	4
0	OFF	OFF	OFF	OFF
1	ON	OFF	OFF	OFF
2	OFF	ON	OFF	OFF
3	ON	ON	OFF	OFF
4	OFF	OFF	ON	OFF
5	ON	OFF	ON	OFF
6	OFF	ON	ON	OFF
7	ON	ON	ON	OFF
8	OFF	OFF	OFF	ON
9	ON	OFF	OFF	ON
10	OFF	ON	OFF	ON
11	ON	ON	OFF	ON
12	OFF	OFF	ON	ON
13	ON	OFF	ON	ON
14	OFF	ON	ON	ON
15	ON	ON	ON	ON

Table 1-15: Card ID Switch Legend

1.5.8 PoE Switch (SW3)

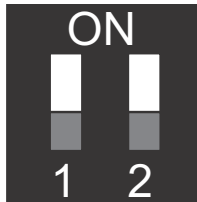

Figure 1-14: PoE Switch

Bit	Definition	
1	PoE HW Switch	Switch ON: PoE Disable
		Switch OFF: PoE Enable (Default)
2	PoE Initial State	Switch ON: PoE OFF @ Power On
		Switch OFF: PoE ON @ Power On (Default)

Table 1-16: PoE Switch Settings

This page intentionally left blank.

2 Getting Started

2.1 Unpacking Checklist

Before unpacking, check the shipping carton for any damage. If the shipping carton and/or contents are damaged, inform your dealer immediately. Retain the shipping carton and packing materials for inspection. Obtain authorization from your dealer before returning any product to ADLINK. Ensure that the following items are included in the package.

- ▶ PCIe-GIE7x unit (PCIe-GIE72, PCIe-GIE72 Pro, PCIe-GIE74 or PCIe-GIE74 Pro)
- ▶ Quick Start Guide



NOTE:

OEM versions with non-standard configuration, functionality, or packaging may vary according to individual requirements.

2.2 Installation

The following describes installation of the PCIe-GIE7x Series module on the PCI express bus.

1. Remove the computer cover according to the computer manual.



NOTE:

A vacant PCI express slot is required for installation of the PCIe-GIE7x Series module; if none is available, remove a PCI express board and note the slot number.

-
2. Remove the slot cover (if any).
 3. Carefully position the PCIe-GIE7x in the selected PCI express slot. If installing in a tower computer, align the board with the board slots.
 4. Press the board firmly but carefully into the connector.
 5. Anchor the board with the screw.
 6. Plug the cable into the PoE power connector.
 7. Connect the device via a Gigabit Ethernet connector.
 8. Power up the computer.



NOTE:

The PCIe-GIE7x can be installed in a PCI Express x4, x8, or x16 slot. Please download the Intel® I210 driver from ADLINK (www.adlinktech.com) or Intel (downloadcenter.intel.com)

Important Safety Instructions

For user safety, please read and follow all instructions, Warnings, Cautions, and Notes marked in this manual and on the associated device before handling/operating the device, to avoid injury or damage.

S'il vous plaît prêter attention stricte à tous les avertissements et mises en garde figurant sur l'appareil , pour éviter des blessures ou des dommages.

- ▶ Read these safety instructions carefully
- ▶ Keep the User's Manual for future reference
- ▶ Read the Specifications section of this manual for detailed information on the recommended operating environment
- ▶ The device can be operated at an ambient temperature of 50°C
- ▶ When installing/mounting or uninstalling/removing device; or when removal of a chassis cover is required for user servicing (See "Getting Started" on page 23.):
 - ▷ Turn off power and unplug any power cords/cables
 - ▷ Reinstall all chassis covers before restoring power
- ▶ To avoid electrical shock and/or damage to device:
 - ▷ Keep device away from water or liquid sources
 - ▷ Keep device away from high heat or humidity
 - ▷ Keep device properly ventilated (do not block or cover ventilation openings)
 - ▷ Always use recommended voltage and power source settings
 - ▷ Always install and operate device near an easily accessible electrical outlet
 - ▷ Secure the power cord (do not place any object on/over the power cord)
 - ▷ Only install/attach and operate device on stable surfaces and/or recommended mountings
- ▶ If the device will not be used for long periods of time, turn off and unplug from its power source

- ▶ Never attempt to repair the device, which should only be serviced by qualified technical personnel using suitable tools
- ▶ A Lithium-type battery may be provided for uninterrupted backup or emergency power.



Risk of explosion if battery is replaced with one of an incorrect type; please dispose of used batteries appropriately.

Risque d'explosion si la pile est remplacée par une autre de type incorrect. Veuillez jeter les piles usagées de façon appropriée.

- ▶ The device must be serviced by authorized technicians when:
 - ▷ The power cord or plug is damaged
 - ▷ Liquid has entered the device interior
 - ▷ The device has been exposed to high humidity and/or moisture
 - ▷ The device is not functioning or does not function according to the User's Manual
 - ▷ The device has been dropped and/or damaged and/or shows obvious signs of breakage
- ▶ Disconnect the power supply cord before loosening the thumbscrews and always fasten the thumbscrews with a screwdriver before starting the system up
- ▶ It is recommended that the device be installed only in a server room or computer room where access is:
 - ▷ Restricted to qualified service personnel or users familiar with restrictions applied to the location, reasons therefor, and any precautions required
 - ▷ Only afforded by the use of a tool or lock and key, or other means of security, and controlled by the authority responsible for the location
- ▶ If PoE (Power over Ethernet) is enabled for the device, the system can ONLY be deployed indoors. Unless otherwise noted, the PoE system is NOT designed to withstand the rigors of outdoor use.

	<p>BURN HAZARD</p> <p>Touching this surface could result in bodily injury. To reduce risk, allow the surface to cool before touching.</p> <p><i>RISQUE DE BRÛLURES</i></p> <p><i>Ne touchez pas cette surface, cela pourrait entraîner des blessures.</i></p> <p><i>Pour éviter tout danger, laissez la surface refroidir avant de la toucher.</i></p>
---	--

This page intentionally left blank.

Getting Service

Ask an Expert: <http://askanexpert.adlinktech.com>

ADLINK Technology, Inc.

Address: 9F, No.166 Jian Yi Road, Zhonghe District
New Taipei City 235, Taiwan
新北市中和區建一路 166 號 9 樓
Tel: +886-2-8226-5877
Fax: +886-2-8226-5717
Email: service@adlinktech.com

Ampro ADLINK Technology, Inc.

Address: 5215 Hellyer Avenue, #110
San Jose, CA 95138, USA
Tel: +1-408-360-0200
Toll Free: +1-800-966-5200 (USA only)
Fax: +1-408-360-0222
Email: info@adlinktech.com

ADLINK Technology (China) Co., Ltd.

Address: 上海市浦东新区张江高科技园区芳春路 300 号 (201203)
300 Fang Chun Rd., Zhangjiang Hi-Tech Park
Pudong New Area, Shanghai, 201203 China
Tel: +86-21-5132-8988
Fax: +86-21-5132-3588
Email: market@adlinktech.com

ADLINK Technology Beijing

Address: 北京市海淀区上地东路 1 号盈创动力大厦 E 座 801 室(100085)
Rm. 801, Power Creative E, No. 1 Shang Di East Rd.
Beijing, 100085 China
Tel: +86-10-5885-8666
Fax: +86-10-5885-8626
Email: market@adlinktech.com

ADLINK Technology Shenzhen

Address: 深圳市南山区科技园南区高新南七道 数字技术园
A1 栋 2 楼 C 区 (518057)
2F, C Block, Bldg. A1, Cyber-Tech Zone, Gao Xin Ave. Sec. 7
High-Tech Industrial Park S., Shenzhen, 518054 China
Tel: +86-755-2643-4858
Fax: +86-755-2664-6353
Email: market@adlinktech.com

LIPPERT ADLINK Technology GmbH

Address: Hans-Thoma-Strasse 11
D-68163 Mannheim, Germany
Tel: +49-621-43214-0
Fax: +49-621 43214-30
Email: emea@adlinktech.com

PENTA ADLINK Technology GmbH

Ulrichsbergerstrasse 17
94469 Deggendorf, Germany
Tel: +49 (0) 991 290 94 – 10
Fax: +49 (0) 991 290 94 - 29
Email: emea@adlinktech.com

ADLINK Technology, Inc. (French Liaison Office)

Address: 6 allée de Londres, Immeuble Ceylan
91940 Les Ulis, France
Tel: +33 (0) 1 60 12 35 66
Fax: +33 (0) 1 60 12 35 66
Email: france@adlinktech.com

ADLINK Technology Japan Corporation

Address: 〒101-0045 東京都千代田区神田鍛冶町 3-7-4
神田 374 ビル 4F
KANADA374 Bldg. 4F, 3-7-4 Kanda Kajicho,
Chiyoda-ku, Tokyo 101-0045, Japan
Tel: +81-3-4455-3722
Fax: +81-3-5209-6013
Email: japan@adlinktech.com

ADLINK Technology, Inc. (Korean Liaison Office)

Address: 경기도 성남시 분당구 수내로 46 번길 4 경동빌딩 2 층
(수내동 4-4 번지) (우) 463-825
2F, Kyungdong B/D, 4 Sunae-ro 46 beon-gil
Bundang-gu, Seongnam-si, Gyeonggi-do, Korea, 463-825
Toll Free +82-80-800-0585
Tel +82-31-786-0585
Fax +82-31-786-0583
Email: korea@adlinktech.com

ADLINK Technology Singapore Pte. Ltd.

Address: 84 Genting Lane #07-02A, Cityneon Design Centre
Singapore 349584
Tel: +65-6844-2261
Fax: +65-6844-2263
Email: singapore@adlinktech.com

ADLINK Technology Singapore Pte. Ltd. (Indian Liaison Office)

Address: #50-56, First Floor, Spearhead Towers
Margosa Main Road (between 16th/17th Cross)
Malleswaram, Bangalore - 560 055, India
Tel: +91-80-65605817, +91-80-42246107
Fax: +91-80-23464606
Email: india@adlinktech.com

ADLINK Technology, Inc. (Israeli Liaison Office)

Address: 27 Maskit St., Corex Building
PO Box 12777
Herzliya 4673300, Israel
Tel: +972-54-632-5251
Fax: +972-77-208-0230
Email: israel@adlinktech.com

ADLINK Technology, Inc. (UK Liaison Office)

Tel: +44 774 010 59 65
Email: UK@adlinktech.com