

TB-24P/24R/16P8R
DIN-24P/24R/24G
Relay Outputs or Isolated Inputs
Terminal Board Series
User' s Guide

@Copyright 1995~2000 ADLink Technology Inc.
All Rights Reserved.

Manual Rev 2.30: April 12, 2000

The information in this document is subject to change without prior notice in order to improve reliability, design and function and does not represent a commitment on the part of the manufacturer.

In no event will the manufacturer be liable for direct, indirect, special, incidental, or consequential damages arising out of the use or inability to use the product or documentation, even if advised of the possibility of such damages.

This document contains proprietary information protected by copyright. All rights are reserved. No part of this manual may be reproduced by any mechanical, electronic, or other means in any form without prior written permission of the manufacturer.

Trademarks

TB-24P, TB-24R, TB-16P8R , DIN-24P, DIN-24R, DIN-24G are registered trademark of ADLink Technology Inc., other product names mentioned herein are used for identification purposes only and may be trademarks and/or registered trademarks of their respective companies.

Getting service from ADLINK

- ◆ **Customer Satisfaction is always the most important thing for ADLINK Tech Inc. If you need any help or service, please contact us and get it.**

| ADLINK Technology Inc. | | | |
|-------------------------------|---|---------------------|-----------------|
| Web Site | http://www.adlink.com.tw | | |
| Sales & Service | service@adlink.com.tw | | |
| Technical Support | NuDAQ | nudaq@adlink.com.tw | |
| | NuDAM | nudam@adlink.com.tw | |
| | NuIPC | nuipc@adlink.com.tw | |
| | NuPRO | nupro@adlink.com.tw | |
| | Software | sw @adlink.com.tw | |
| | AMB | amb@adlink.com.tw | |
| TEL | +886-2-82265877 | FAX | +886-2-82265717 |
| Address | 9F, No. 166, Jian Yi Road, Chungho City, Taipei, 235 Taiwan, R.O.C. | | |

- ◆ **Please inform or FAX us of your detailed information for a prompt, satisfactory and constant service.**

| Detailed Company Information | | | |
|-------------------------------------|---|-----|--|
| Company/Organization | | | |
| Contact Person | | | |
| E-mail Address | | | |
| Address | | | |
| Country | | | |
| TEL | | FAX | |
| Web Site | | | |
| Questions | | | |
| Product Model | | | |
| Environment to Use | OS _____ Computer Brand _____ MB : CPU : Chipset : Bios : Video Card : Network Interface Card : Other : | | |
| Challenge Description | | | |
| Suggestions for ADLink | | | |

Table of Contents

| | |
|---------------------------------|----|
| How to Use This Guide | ii |
| TB-24P | 1 |
| 1.1 Introductions | 1 |
| 1.2 Specifications | 1 |
| 1.3 Descriptions | 2 |
| TB-24R | 6 |
| 2.1 Introduction | 6 |
| 2.2 Specification | 6 |
| 2.3 Description | 7 |
| TB-16P8R | 11 |
| 3.1 Introduction | 11 |
| 3.2 Specification | 11 |
| 3.3 Description | 12 |
| DIN-24P | 16 |
| 4.1 Introductions | 16 |
| 4.2 Specifications | 16 |
| 4.3 Descriptions | 17 |
| DIN-24R | 22 |
| 5.1 Introduction | 22 |
| 5.2 Specification | 22 |
| 5.3 Description | 23 |
| DIN-24G | 28 |
| 6.1 Introduction | 28 |
| 6.2 Specification | 28 |
| 6.3 Description | 28 |
| Product Warranty/Service..... | 30 |

How to Use This Guide

This manual is designed to help you use the TB-24P/24R/16P8R. The manual describes how to modify various settings on the TB-24P/24R/16P8R terminal board to meet your requirements.

- Chapter 1, "TB-24P : 24 Opto-isolated Digital Inputs Terminal Board", gives an overview of the TB-24P's features, description, and specifications.
- Chapter 2, "TB-24R : 24 Relay Outputs Terminal Board", gives an overview of the TB-24R's features, description, and specifications.
- Chapter 3, "TB-16P8R : 16 Opto-isolated Digital Inputs & 8 Relay Outputs Terminal Board", gives an overview of the TB-16P8R features, description, and specification
- Chapter 4, "DIN-24P: 24 Opto-isolated Digital Inputs Terminal Board", gives an overview of the DIN-24P's features, description, and specifications.
- Chapter 5, "DIN-24R: 24 Relay Outputs Terminal Board", gives an overview of the DIN-24R's features, description, and specifications.
- Chapter 6, "DIN-24G: Terminal Board with 24 module rack for connecting I/O modules, gives an overview of the DIN-24G features, description, and specification



TB-24P

24 Opto-isolated Digital Inputs Terminal Board

1.1 Introductions

TB - 24P is an input extension board with 24 isolated photo couplers. CN1, CN2, CN3 and CN4 are terminal blocks to connect with external devices. CN5 is a 50 pins connector to connect with opto-22 compatible connector, such as ACL-7124, ACL-7122, PET-48DIO, PCI-7248, PCI-7296 etc. All input ports are with LED indicators.

1.2 Specifications

| | |
|-----------------------------------|--------------------------------|
| Indication Display | : 24 LEDs for input indication |
| Input electrical characteristicly | |
| Logic input low voltage | : <0.8 V DC |
| Logic input high voltage | : +3V DC to +24V DC |
| Logic input high current | : 6.3mA to 50mA |
| Logic "1" | : Voltage input high |
| Logic "0" | : Voltage input low |
| Isolation voltage | : 2500V DC |

1.3 Descriptions

TB-24P has 5 connectors and 24 LEDs. The following Figure shows their placement on TB-24P.

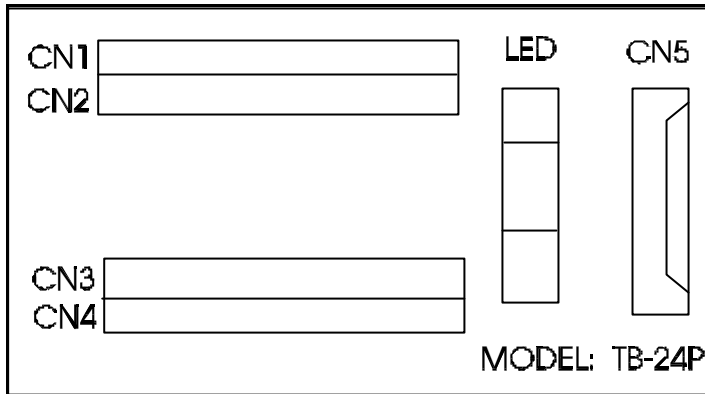

Outline of TB-24P

TB-24P has 24 LEDs to indicate input status, the LED mapping and logic definition are shown as the following table.

| LED No. | Indication Display | Color of LED | Channel |
|---------|--------------------|--------------|---------|
| LED 0 | PA0 | GREEN | CH0 |
| LED 7 | PA7 | GREEN | CH7 |
| LED8 | PB0 | YELLOW | CH8 |
| LED 15 | PB7 | YELLOW | CH15 |
| LED 16 | PC0 | RED | CH16 |
| LED 23 | PC7 | RED | CH23 |

LED mapping table

| | |
|-----------|-----------|
| Logic "1" | LED "ON" |
| Logic "0" | LED "OFF" |

Logic define

Each input channel can connect with opto-22 compatible Digital I/O board, such as ACL-7122, PET-48DIO, PCI-7248/96 etc. directly or through photo coupler, and the upper of each photo coupler has a jumper to select.

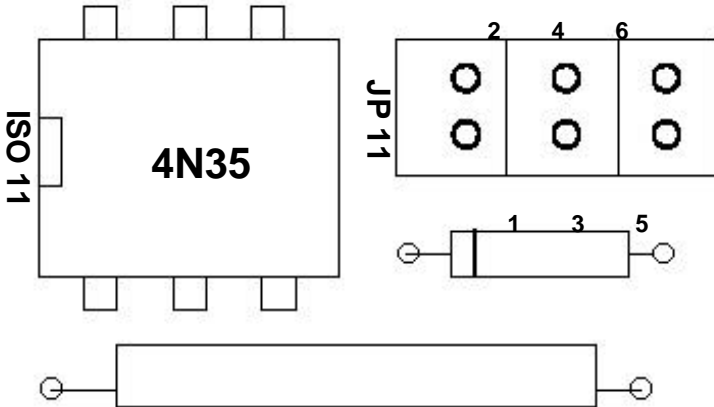

The positioning of each setting jumper

Each input port has two mini jumpers for setting.

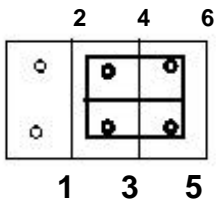

- * Photo coupler is used
- * It is for voltage input (Factory setting)

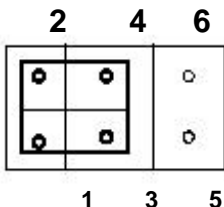

- * Photo coupler is not used
- * It is for “dry contact”

The input circuit is shown as the following figure.

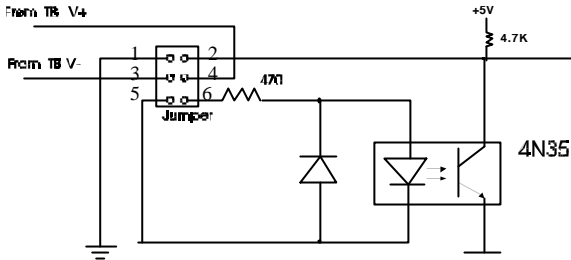

Each input channel has two terminal blocks. The pin definition of the terminal block is shown as the following tables.

CN1

| CH12 | | CH14 | | CH16 | | CH18 | | CH20 | | CH22 | |
|------|---|------|---|------|---|------|---|------|---|------|---|
| V | V | V | V | V | V | V | V | V | V | V | V |
| + | - | + | - | + | - | + | - | + | - | + | - |

CN2

| CH13 | | CH15 | | CH17 | | CH19 | | CH21 | | CH23 | |
|------|---|------|---|------|---|------|---|------|---|------|---|
| V | V | V | V | V | V | V | V | V | V | V | V |
| + | - | + | - | + | - | + | - | + | - | + | - |

CN3

| CH0 | | CH2 | | CH4 | | CH6 | | CH8 | | CH10 | |
|-----|---|-----|---|-----|---|-----|---|-----|---|------|---|
| V | V | V | V | V | V | V | V | V | V | V | V |
| + | - | + | - | + | - | + | - | + | - | + | - |

CN4

| CH1 | | CH3 | | CH5 | | CH7 | | CH9 | | CH11 | |
|-----|---|-----|---|-----|---|-----|---|-----|---|------|---|
| V | V | V | V | V | V | V | V | V | V | V | V |
| + | - | + | - | + | - | + | - | + | - | + | - |

The CN5 is an opto-22 compatible connector, which pin assignment is shown as the following figure.

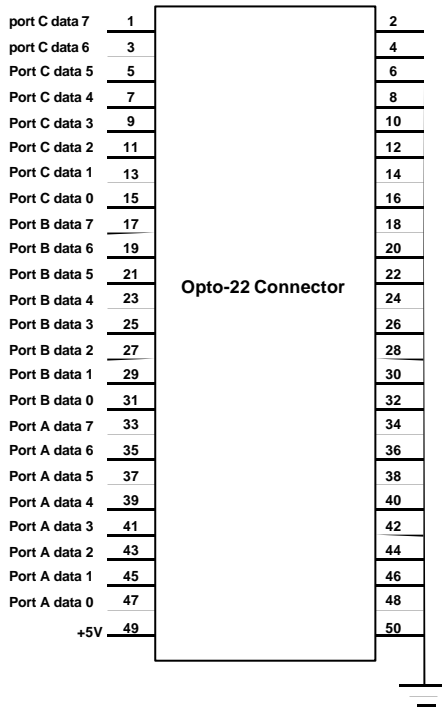

CN5 pins definition

TB-24R

24 Relay Outputs Terminal Board

2.1 Introduction

TB - 24R is an output extension board with 24 relays. CN1, CN2, CN3 and CN4 are terminal blocks to connect with external devices. CN5 connect with external power source. TB-24R/12 uses +12V power, but TB-24R/24 uses +24V power. CN6 is used to connect the opto-22 compatible connector, such as ACL-7122, ACL-7124, PET-48DIO, PCI-7248/96 etc.

2.2 Specification

Indication display : 24 LEDs
 Relay type : High sensitive 1500 V FCC surge with standing miniature relay.
 Relay form : SPDT
 Contact rating :

| | |
|------------------------|--------------------|
| Max. switching power | 60 W, 125 VA |
| Max. switching voltage | 220 V DC, 250 V AC |
| Max. switching current | 2 A DC, AC |
| Max. carrying current | 3 A DC, AC |
| UL/CSA rating | 0.6 A 125 V AC |
| UL/CSA rating | 0.6 A 110 V DC |
| UL/CSA rating | 2 A 30 V DC |

Coil voltage : 12 V DC for TB-24R/12
 : 24V DC for TB-24R/24

2.3 Description

TB-24R has six connectors. The figure as below is the placement of these connectors.

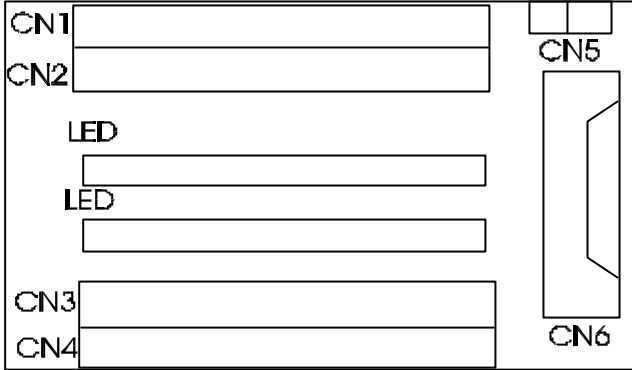

Outline of TB - 24R

The 24 LEDs are the indicators of output channels. The mapping of LED and Logic definition are shown as the following table.

| LED No. | Indication Display | Color of LED | Channel |
|---------|--------------------|--------------|---------|
| LED0 | PA0 | GREEN | CH0 |
| | | | |
| LED7 | PA7 | GREEN | CH7 |
| LED8 | PB0 | YELLOW | CH8 |
| | | | |
| LED15 | PB7 | YELLOW | CH15 |
| LED16 | PC0 | RED | CH16 |
| | | | |
| LED23 | PC7 | RED | CH23 |

LEDs Mapping Table

| | |
|-----------|-----------|
| Logic "1" | LED " ON" |
| Logic "0" | LED "OFF" |

Logic Define Table

CN1, CN2, CN3 and CN4 are terminal blocks to be connected with external device.

Each output channel has three terminals, the definition of each terminal is shown as the following figure.

| Channel No. | | |
|-------------|--------------|-------------|
| Common | Normal close | Normal open |

Terminal block definition of each channel

The mapping of channel number and connector number is shown as the following figure.

| | | | | | | |
|-----|------|------|------|------|------|------|
| CN1 | CH12 | CH14 | CH16 | CH18 | CH20 | CH22 |
| CN2 | CH13 | CH15 | CH17 | CH19 | CH21 | CH23 |

| | | | | | | |
|-----|-----|-----|-----|-----|-----|------|
| CN3 | CH0 | CH2 | CH4 | CH6 | CH8 | CH10 |
| CN4 | CH1 | CH3 | CH5 | CH7 | CH9 | CH11 |

The relationship of channel number and CN1,CN2,CN3,CN4

The CN5 is used to connect with external power source. The following figure shows CN5 connection.

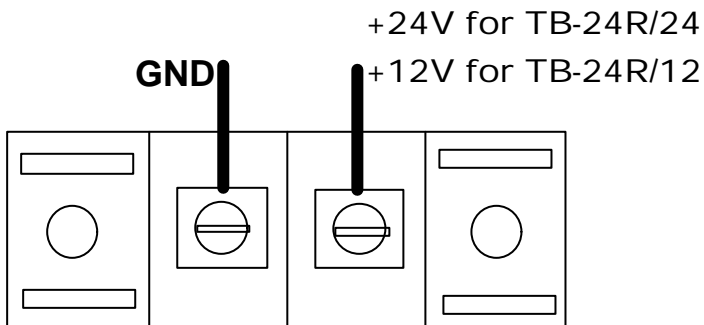

CN5 connection

The output circuits are shown as the following figure.

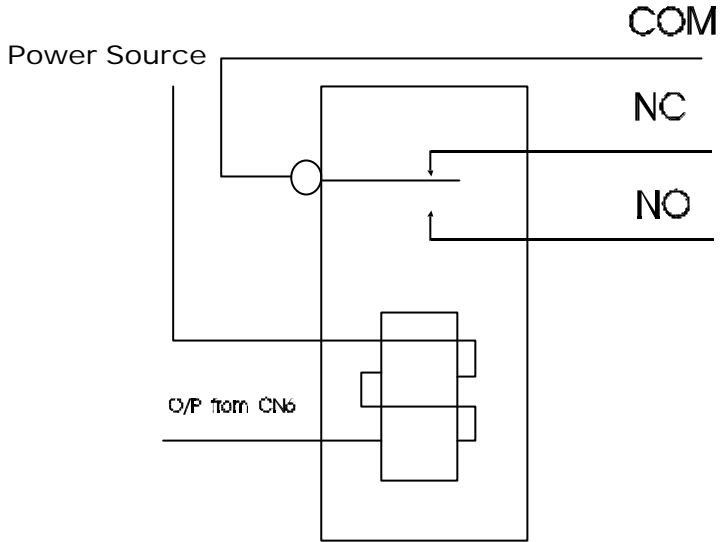

TB-24R/12: Relay is DSIE-S-DC12V, it need +12V power source
TB-24R/24: Relay is DSIE-S-DC24V, it need +24V power source

The CN6 is used to connect with opto-22 compatible connector, such as ACL-7122, ACL-7124, or PET-48DIO, PCI-7248/96 etc. the pin assignment is defined as the following figure.

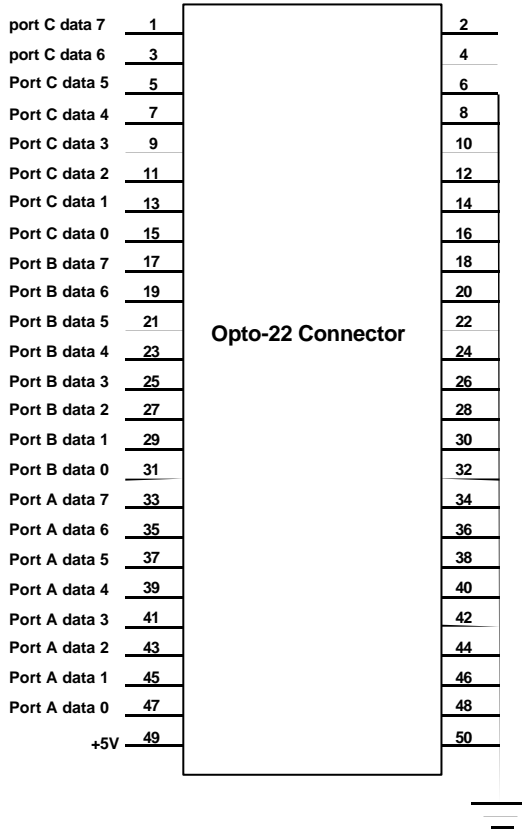

CN6 pin definition

TB-16P8R

16 Opto-isolated Inputs & 8 Relay Outputs Terminal Board

3.1 Introduction

The TB-16P8R is input / output extension board with 16 input channels and 8 output channels. All inputs channels are with photo couplers, and all outputs are with relays. Terminal blocks on TB-16P8R are used to connect with external devices. TB-16P8R has the same photo coupler circuitry as the TB-24P, please refer to TB-24P for details.

3.2 Specification

| | |
|------------------------------------|--|
| Indication Display | : 24 LEDs for input/output indication |
| Input electrical characteristicly: | |
| Logic input low voltage | : < 0.8 V DC |
| Logic input high voltage | : +3V DC to +24V DC |
| Logic input high current | : 6.3mA to 50mA |
| Logic "1" | : Voltage input high |
| Logic "0" | : Voltage input low |
| Isolation voltage | : 2500V DC |
| Relay type | : High sensitive 1500 V FCC surge with standing miniature relay. |
| Relay form | : SPDT |

Contact rating:

| | |
|------------------------|--------------------|
| Max. switching power | 60 W, 125 VA |
| Max. switching voltage | 220 V DC, 250 V AC |
| Max. switching current | 2 A DC, AC |
| Max. carrying current | 3 A DC, AC |
| UL/CSA rating | 0.6 A 125 V AC |
| UL/CSA rating | 0.6 A 110 V DC |
| UL/CSA rating | 2 A 30 V DC |

Coil voltage: 12 V DC for TB-16P8R/12
24 V DC for TB-16P8R/24

3.3 Description

TB-16P8R has 6 connectors and 24 LEDs. The following Figure shows the placement of TB-16P8R.

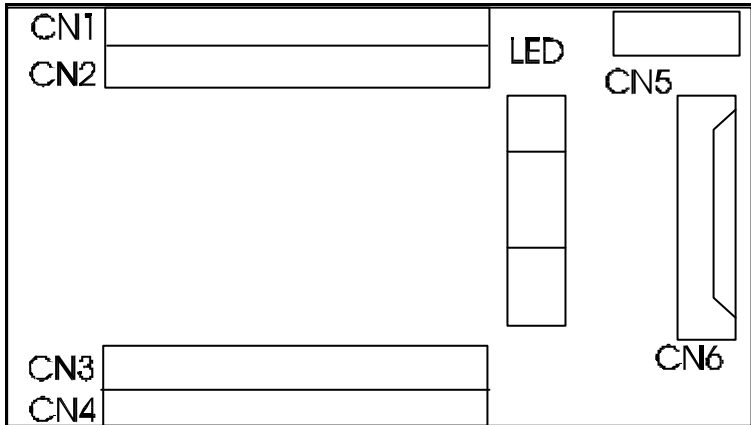

TB-16P8R Outline

The CN5 is used to connect with external power source.
 The CN1, CN2 are terminal blocks for input connection.
 The CN3, CN4 are terminal blocks for output connection.
 The CN6 is used to connect with the opto-22 compatible connector, such as ACL-7122 or PET-48DIO PCI-7248/96. (Please set the I/O mode as mode 7).

The design of input port is same as TB-24P. JP8 to JP23 are for dry contact or using photo coupler setting.

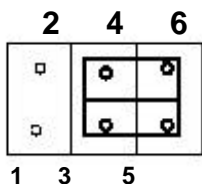

**Photo Coupler is used
 Voltage Input
 (Factory setting)**

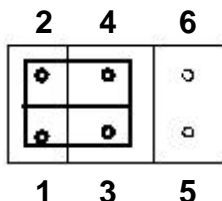

**Photo Coupler is
 not used**

The input port of TB-16P8R is the same as TB-24P. Each input channel has two terminal blocks. The pin definition of CN1, CN2 is showing as following figure.

CN1

| CH8 | CH10 | CH12 | CH14 | CH16 | CH18 | CH20 | CH22 |
|-----|------|------|------|------|------|------|------|
| V | V | V | V | V | V | V | V |
| + | - | + | - | + | - | + | - |

CN2

| CH9 | CH11 | CH13 | CH15 | CH17 | CH19 | CH21 | CH23 |
|-----|------|------|------|------|------|------|------|
| V | V | V | V | V | V | V | V |
| + | - | + | - | + | - | + | - |

The output port of TB-16P8R is the same as TB-24R. Each output channel has three terminals.

| Channel No. | | |
|-------------|--------------|-------------|
| Common | Normal close | Normal open |

The relationship of channel number and CN3, CN4 is shown as the following table.

| | | | | |
|-----|-----|-----|-----|-----|
| CN3 | CH0 | CH2 | CH4 | CH6 |
| CN4 | CH1 | CH3 | CH5 | CH7 |

The relationship of LED, channel and output port is showing as table.

| LED No. | Indication Display | Color of LED | Channel |
|---------|--------------------|--------------|---------|
| LED 0 | PA0 | GREEN | CH0 |
| | | | |
| LED 7 | PA7 | GREEN | CH7 |
| LED8 | PB0 | YELLOW | CH8 |
| | | | |
| LED 15 | PB7 | YELLOW | CH15 |
| LED 16 | PC0 | RED | CH16 |
| | | | |
| LED 23 | PC7 | RED | CH23 |

The CN5 is to connect external power source. Figure shows connecting.

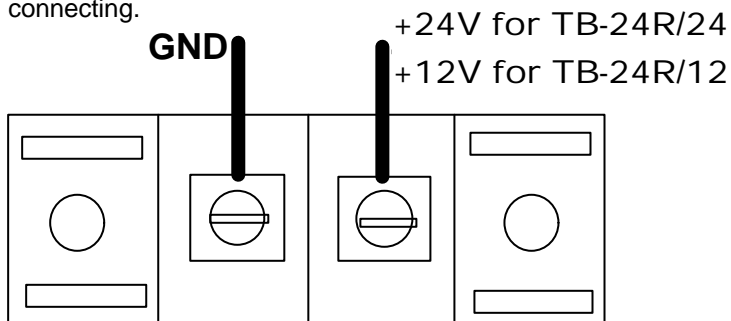

TB-16P8R/12: Relay is DSIE-S-DC12V and it needs +12V power source

TB-16P8R/24: Relay is DSIE-S-DC24V and it needs +24V power source

The CN6 is an opto-22 compatible connector. The following figure shows the pin definition of CN6.

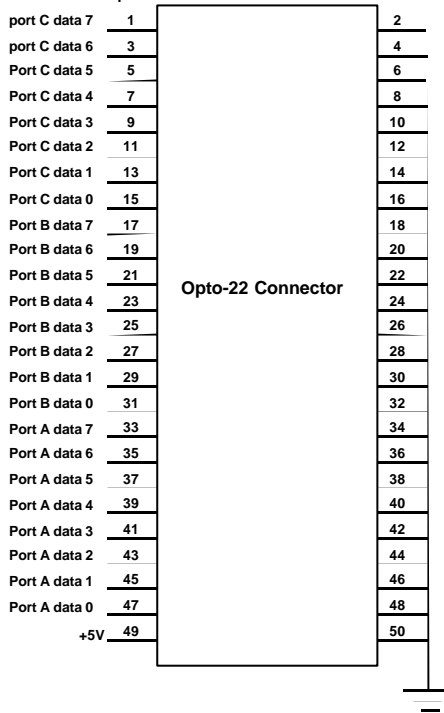

CN6 pin definition

PORT A: Relay Output

PORT B,C : Opto-isolated Input

The 8 relay output channels (8R) connect with PET-48DIO port A through CN6, and 16 photo coupler input channels (16p) connect with PET-48DIO port B,C through CN6.

DIN-24P

24 Opto-isolated Digital Inputs Terminal Board

4.1 Introductions

DIN - 24P is an input extension board with 24 isolated photo couplers. CN7 and CN8 are terminal blocks used to connect with external devices. CN5 is a 50 pin connector used to connect with opto-22 compatible connector, such as ACL-7124, ACL-7122, PET-48DIO...etc, and CN6 is a 50-pin connector used to connect with 50-pin SCSI connector, such as ND-6058. All input channels are with LED indicators.

4.2 Specifications

| | |
|-------------------------------------|--------------------------------|
| Indication Display | : 24 LEDs for input indication |
| Input electrical characteristically | |
| Logic input low voltage | : <0.8 V DC |
| Logic input high voltage | : +3V DC to +24V DC |
| Logic input high current | : 6.3mA to 50mA |
| Logic "1" | : Voltage input high |
| Logic "0" | : Voltage input low |
| Isolation voltage | : 5000Vrms |

4.3 Descriptions

DIN-24P has 4 connectors and 24 LEDs. The following figure shows their placement on DIN-24P.

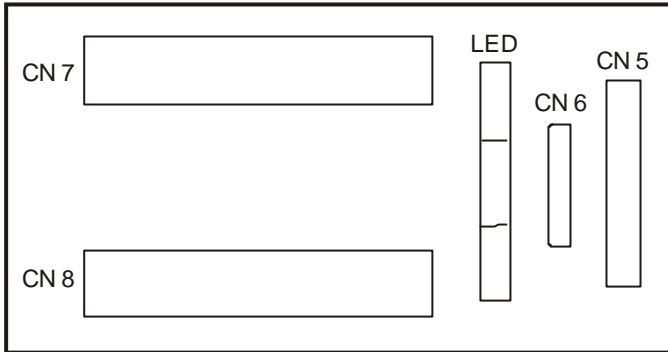

Outline of DIN-24P

DIN-24P has 24 LEDs to indicate input status, the LED mapping and logic definition are show as the following table.

| LED No. | Indication Display | Color of LED | Channel |
|---------|--------------------|--------------|---------|
| LED 0 | PA0 | YELLOW | CH0 |
| LED 7 | PA7 | YELLOW | CH7 |
| LED8 | PB0 | GREEN | CH8 |
| LED 15 | PB7 | GREEN | CH15 |
| LED 16 | PC0 | RED | CH16 |
| LED 23 | PC7 | RED | CH23 |

LED mapping table

| | |
|-----------|-----------|
| Logic "1" | LED "ON" |
| Logic "0" | LED "OFF" |

Logic define

The DIN-24P can be connected with opto-22 compatible digital I/O board, such as ACL-7122 and PET-48DIO, PCI-7248/96, or digital I/O module equipped with 50-pin SCSI type connector such as ND-6058. Each channel can be connect to external device directly or through a photo coupler, and each photo coupler has a jumper to select the input configuration.

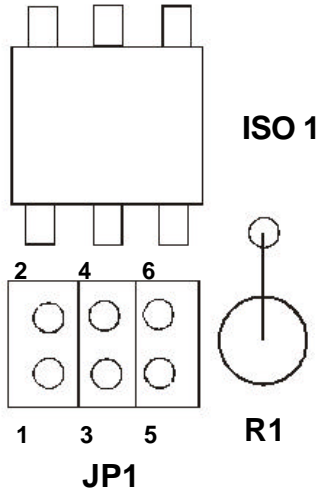

The positioning of each setting jumper

Each input port has two mini jumpers for setting.



The input circuit shows as figure.

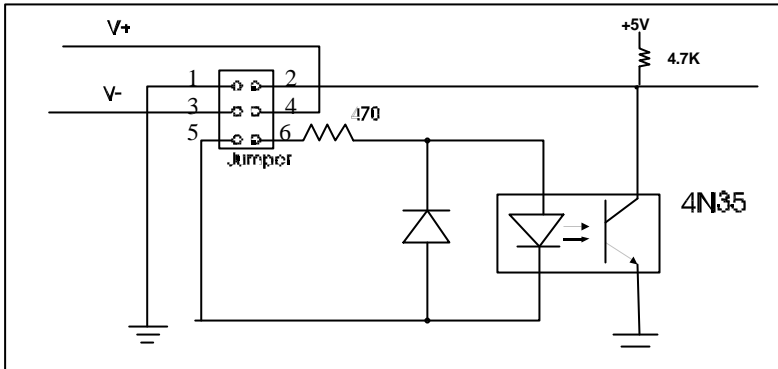

The DIN-24P has two terminal blocks. The terminal block pin definitions are shown as the following figure.

CN7

| CH12 | | CH14 | | CH16 | | CH18 | | CH20 | | CH22 | |
|------|---|------|---|------|---|------|---|------|---|------|---|
| V | V | V | V | V | V | V | V | V | V | V | V |
| - | + | - | + | - | + | - | + | - | + | - | + |
| CH13 | | CH15 | | CH17 | | CH19 | | CH21 | | CH23 | |
| V | V | V | V | V | V | V | V | V | V | V | V |
| - | + | - | + | - | + | - | + | - | + | - | + |

CN8

| CH0 | | CH2 | | CH4 | | CH6 | | CH8 | | CH10 | |
|-----|---|-----|---|-----|---|-----|---|-----|---|------|---|
| V | V | V | V | V | V | V | V | V | V | V | V |
| - | + | - | + | - | + | - | + | - | + | - | + |
| CH1 | | CH3 | | CH5 | | CH7 | | CH9 | | CH11 | |
| V | V | V | V | V | V | V | V | V | V | V | V |
| - | + | - | + | - | + | - | + | - | + | - | + |

The CN5 is an opto-22 compatible connector, which pin assignment is shown as the following figure.

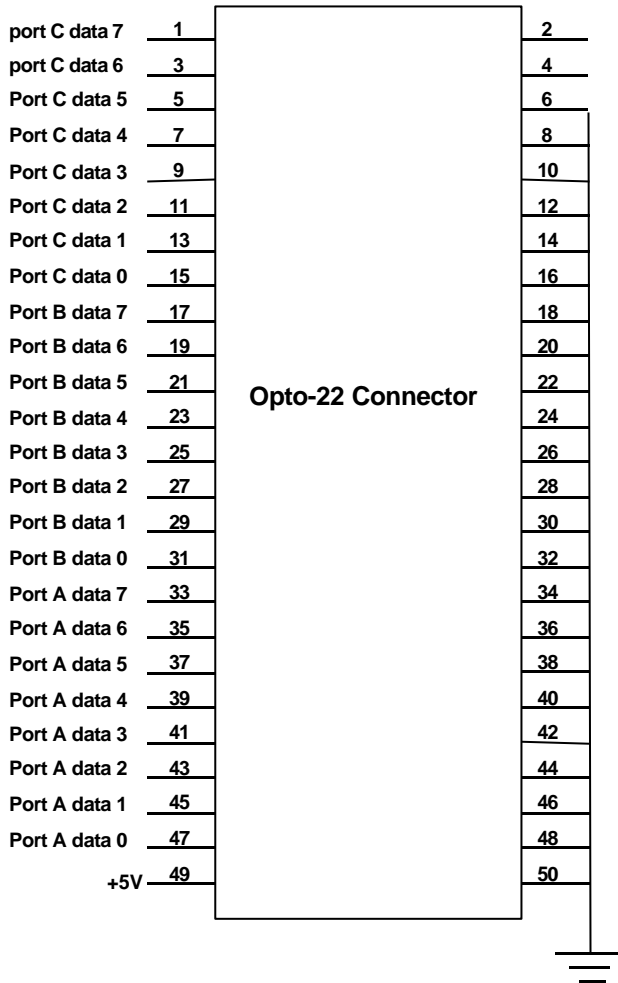

The CN6 is an 50-pin SCSI connector, which pin assignment is shown as the following figure.

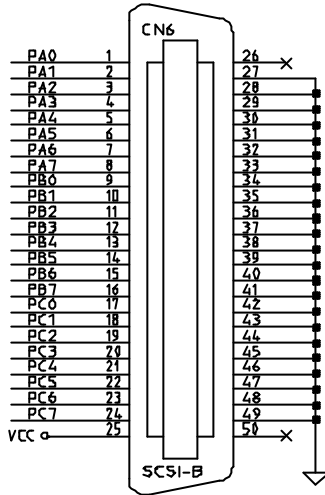

CN6 pin definition

5.3 Description

DIN-24R has five connectors. The following figure shows the placement of these connectors.

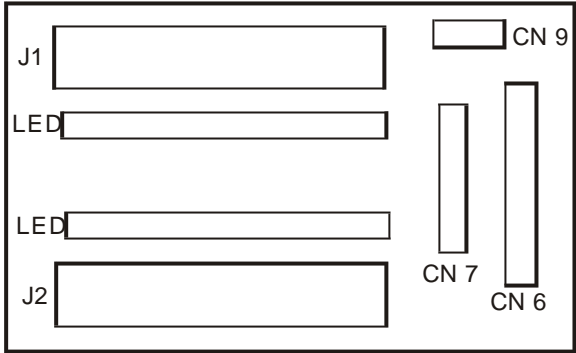

Outline of DIN - 24R

The 24 LEDs are indicators of output channels. The mapping of LED and Logic definition are shown as the following table.

| LED No. | Indication Display | Color of LED | Channel |
|---------|--------------------|--------------|---------|
| LED0 | PA0 | RED | CH0 |
| | | | |
| LED7 | PA7 | RED | CH7 |
| LED8 | PB0 | YELLOW | CH8 |
| | | | |
| LED15 | PB7 | YELLOW | CH15 |
| LED16 | PC0 | GREEN | CH16 |
| | | | |
| LED23 | PC7 | GREEN | CH23 |

LEDs Mapping Table

| | |
|-----------|-----------|
| Logic "1" | LED " ON" |
| Logic "0" | LED "OFF" |

Logic Define Table

J1 and J2 are terminal blocks to connect with external device.

Each output channel has three terminals, which definition is shown as the following figure.

| Channel No. | | |
|-------------|--------------|-------------|
| Common | Normal close | Normal open |

Terminal definition of each channel

The relationship of channel number and J1, J2 are shown as the following figure.

J1

| | | | | | |
|------|------|------|------|------|------|
| CH22 | CH20 | CH18 | CH16 | CH14 | CH12 |
| CH23 | CH21 | CH19 | CH17 | CH15 | CH13 |

J2

| | | | | | |
|------|-----|-----|-----|-----|-----|
| CH10 | CH8 | CH6 | CH4 | CH2 | CH0 |
| CH11 | CH9 | CH7 | CH5 | CH3 | CH1 |

The CN9 is used to connect with external power source. The following figures show CN9 connection.

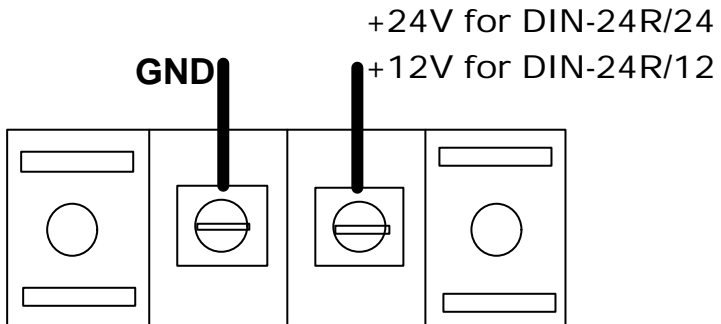

CN5 connection

The output circuit is shown as the following figure.

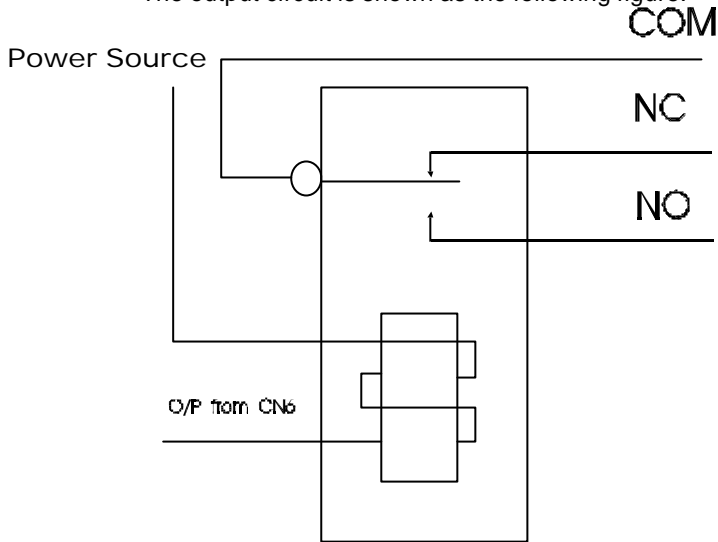

DIN-24R/12: Relay is DSIE-S-DC12V, and it need +12V power source

DIN-24R/24: Relay is DSIE-S-DC24V, and it need +24V power source

The CN6 is used to connect with opto-22 compatible boards, such as ACL-7122, ACL-7124, PET-48DIO, etc. Its pin assignment is defined as the following figure.

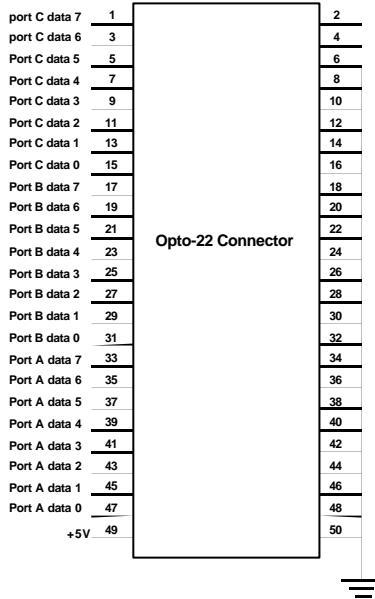

CN6 pins' define figure

The CN7 is used to connect with DIO board with 50-pin SCSI connector, such as ND-6058. Its pin assignment is defined as the following figure.

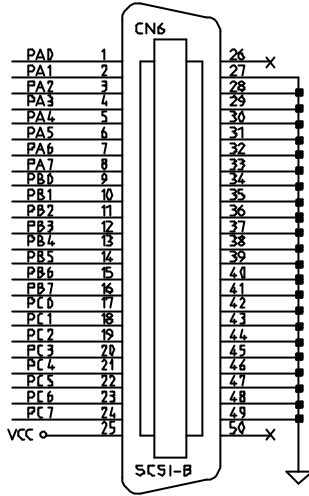

CN7 pin definition

6

DIN-24G

24 I/O Module Terminal Board

6.1 Introduction

The DIN-24G is I/O module terminal board with 24 positions to mount I/O module. The types of module include DC input, DC output, AC input, AC output. And it could extend the application of DI/O cards and DI/O modules.

6.2 Specification

1. Supply 24 position mount I/O modules
2. Supply terminal blocks to connect with external device.
3. Support 50 pin straight header connector to connect with DAQ boards.

6.3 Description

DIN-24G has 6 connectors. The following Figure shows the

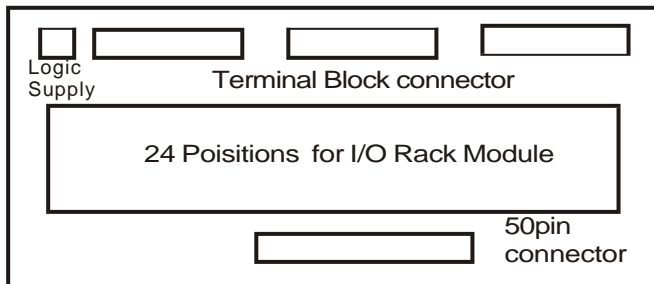

placement on Din-24G.

DIN-24G Outline

The Logic Supply is to supply logic power for the operation of modules.

The Terminal Block is terminal block for field wiring.

The 50-pin connector is to connect the NuDAQ or NuDAM.

The 24 positions are to connect with I/O rack module.

The following is pin definition of 50-pin connector.

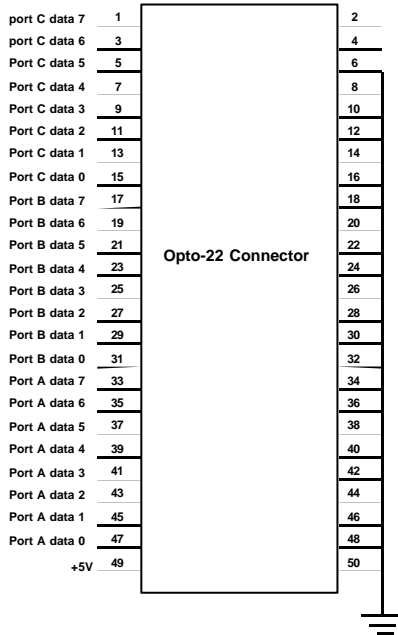

Product Warranty/Service

Seller warrants that equipment furnished will be free from defects in material and workmanship for a period of one year from the confirmed date of purchase of the original buyer and that upon written notice of any such defect, Seller will, at its option, repair or replace the defective item under the terms of this warranty, subject to the provisions and specific exclusions listed herein.

This warranty shall not apply to equipment that has been previously repaired or altered outside our plant in any way as to, in the judgment of the manufacturer, affect its reliability. Nor will it apply if the equipment has been used in a manner exceeding its specifications or if the serial number has been removed.

Seller does not assume any liability for consequential damages as a result from our products uses, and in any event our liability shall not exceed the original selling price of the equipment.

The equipment warranty shall constitute the sole and exclusive remedy of any Buyer of Seller equipment and the sole and exclusive liability of the Seller, its successors or assigns, in connection with equipment purchased and in lieu of all other warranties expressed implied or statutory, including, but not limited to, any implied warranty of merchant ability or fitness and all other obligations or liabilities of seller, its successors or assigns.

The equipment must be returned postage-prepaid. Package it securely and insure it. You will be charged for parts and labor if you lack proof of date of purchase, or if the warranty period is expired.