



## **IGS-3032GC**

### **Industrial Managed Ethernet Switch**

## **User Manual**

**Version 5.0**

**March, 2015**

[www.oring-networking.com](http://www.oring-networking.com)

## **COPYRIGHT NOTICE**

Copyright © 2015 ORing Industrial Networking Corp.

All rights reserved.

No part of this publication may be reproduced in any form without the prior written consent of ORing Industrial Networking Corp.

## **TRADEMARKS**

**ORing** is a registered trademark of ORing Industrial Networking Corp.

All other trademarks belong to their respective owners.

## **REGULATORY COMPLIANCE STATEMENT**

Product(s) associated with this publication complies/comply with all applicable regulations. Please refer to the Technical Specifications section for more details.

## **WARRANTY**

ORing warrants that all ORing products are free from defects in material and workmanship for a specified warranty period from the invoice date (5 years for most products). ORing will repair or replace products found by ORing to be defective within this warranty period, with shipment expenses apportioned by ORing and the distributor. This warranty does not cover product modifications or repairs done by persons other than ORing-approved personnel, and this warranty does not apply to ORing products that are misused, abused, improperly installed, or damaged by accidents.

Please refer to the Technical Specifications section for the actual warranty period(s) of the product(s) associated with this publication.

## **DISCLAIMER**

Information in this publication is intended to be accurate. ORing shall not be responsible for its use or infringements on third-parties as a result of its use. There may occasionally be unintentional errors on this publication. ORing reserves the right to revise the contents of this publication without notice.

## **CONTACT INFORMATION**

### **ORing Industrial Networking Corp.**

3F., NO.542-2, Jhongjheng Rd., Sindian District, New Taipei City 23145, Taiwan, R.O.C.

Tel: + 886 2 2218 1066 // Fax: + 886 2 22181014

Website: [www.oring-networking.com](http://www.oring-networking.com)

### **Technical Support**

E-mail: [support@oring-networking.com](mailto:support@oring-networking.com)

### **Sales Contact**

E-mail: [sales@oring-networking.com](mailto:sales@oring-networking.com) (Headquarters) [sales@oring-networking.com.cn](mailto:sales@oring-networking.com.cn) (China)

# Table of Content

<b>Getting Started .....</b>	<b>5</b>
1.1 About the IGS-3032GC Series .....	5
1.2 Software Features .....	5
1.3 Hardware Features .....	5
<b>Hardware Overview.....</b>	<b>7</b>
2.1 Front Panel.....	7
2.2 Front Panel LEDs .....	8
2.3 Bottom Panel.....	8
2.4 Rear Panel .....	9
<b>Hardware Installation.....</b>	<b>10</b>
3.1 DIN-rail Installation .....	10
3.2 Wall Mounting.....	11
3.3 Wiring.....	12
3.3.1 Grounding .....	13
3.3.2 Fault Relay.....	13
3.3.3 Redundant Power Inputs .....	13
3.4 Connection .....	13
3.4.1 Cables.....	13
3.4.2 SFP.....	16
3.4.3 O-Ring/O-Chain .....	16
<b>Redundancy .....</b>	<b>20</b>
4.1 O-Ring .....	20
4.1.1 Introduction .....	20
4.1.2 Configurations .....	20
4.2 Open-Ring.....	22
4.2.1 Introduction .....	22
4.2.2 Configurations .....	22
4.3 O-Chain .....	23
4.3.1 Introduction .....	23
4.3.2 Configurations .....	23
4.4 MRP.....	24
4.4.1 Introduction .....	24

4.4.2	Configurations .....	24
4.5	STP/RSTP/MSTP .....	25
4.5.1	STP/RSTP .....	25
4.5.2	MSTP.....	28
4.6	Fast Recovery.....	32
<b>Management.....</b>		<b>34</b>
5.1	Basic Settings.....	35
5.1.1	System Information .....	35
5.1.2	System Setting.....	36
5.1.3	Admin & Password .....	37
5.1.4	IP Setting .....	37
5.1.5	Time Setting.....	38
5.1.6	LLDP.....	41
5.1.7	Modbus TCP .....	41
5.1.8	Auto Provision.....	42
5.1.9	Backup & Restore .....	42
5.1.10	Upgrade Firmware.....	43
5.2	Multicast.....	44
5.2.1	IGMP Snooping.....	44
5.2.2	MVR.....	45
5.2.3	Static Multicast Filtering.....	45
5.2.4	Port Setting .....	46
5.2.5	Port Status .....	47
5.2.6	Port Alias.....	47
5.2.7	Rate Limit.....	48
5.2.8	Port Trunking.....	49
5.2.9	Loop Guard.....	50
5.3	VLAN .....	51
5.3.1	VLAN Setting - IEEE 802.1Q .....	51
5.4	Traffic Prioritization.....	53
5.4.1	QoS Policy .....	54
5.4.2	Port-base Priority.....	55
5.4.3	COS/802.1p .....	55
5.4.4	TOS/DSCP.....	56
5.5	DHCP Server.....	56
5.5.1	Basic Setting.....	57

5.5.2	Client List .....	58
5.5.3	Port and IP Bindings.....	58
5.5.4	Relay Agent.....	58
5.6	SNMP.....	60
5.6.1	Agent Setting.....	60
5.6.2	Trap Setting.....	61
5.6.3	SNMPV3.....	62
5.7	Security .....	64
5.7.1	IP Security.....	64
5.7.2	IP Guard.....	70
5.8	Warning.....	72
5.8.1	SYSLOG Setting .....	72
5.8.2	SMTP Setting.....	72
5.8.3	Event Selection .....	73
5.9	Monitor and Diag.....	74
5.9.1	System Event Log .....	74
5.9.2	MAC Address Table.....	75
5.9.3	Port Counters.....	77
5.9.4	Ping .....	81
5.10	Save Configuration.....	82
5.11	Factory Default.....	83
5.12	System Reboot.....	83
 <b>Command Line Interface Management .....</b>		<b>84</b>

# Getting Started

## 1.1 About the IGS-3032GC Series

The IGS-3032GC is a powerful managed industrial switch designed for extreme temperatures, dusty environments, and high humidity. With three 10/100/1000Base-T(X) and two Gigabit combo ports, the IGS-3032GC can be managed via web browsers, TELNET, Console or other third-party SNMP software as well as ORing's proprietary management utility Open-Vision. The device supports a variety of Ethernet redundancy protocols such as *O-Ring* (recovery time < 20ms over 250 units of connection), *Open-Ring*, and MSTP/RSTP/STP (IEEE 802.1s/w/ D) to protect your mission-critical applications from network interruptions or temporary malfunctions.

## 1.2 Software Features

- Supports O-Ring (Recovery time < 10ms over 250 units connection)
- Supports Ring Coupling, Dual Homing over O-Ring
- Supports SNMPv1/v2/v3 & RMON & Port base/802.1Q VLAN Network Management
- Event notification by email, SNMP trap, and relay output
- Web-based, Telnet, Console (CLI) configuration
- Enable/disable ports, MAC based port security
- Port-based network access control (802.1x)
- Supports VLAN (802.1Q ) to segregate and secure network traffic
- Radius centralized password management
- SNMPv3 encrypted authentication and access security
- RSTP (802.1w)
- Quality of Service (802.1p) for real-time traffic
- VLAN (802.1Q) with double tagging and GVRP supported
- IGMP snooping for multicast filtering
- Port configuration, status, statistics, mirroring, security
- Remote monitoring (RMON)

## 1.3 Hardware Features

- 3 x 10/100/1000Base-T(X) Ethernet ports
- 2 x 100/1000Base-X SFP & 10/100/1000Base-TX COMBO ports
- 1 x console port
- Dual DC power inputs
- Wide operating temperature: -40 to 70°C
- Storage temperature: -40 to 85°C

- Operating humidity: 5% to 95%, non-condensing
- Casing: IP-30
- Dimensions (W x D x H): 54.1(W)x106.1(D)x145.4(H) mm (2.13x4.18x5.72 inch.)

# Hardware Overview

## 2.1 Front Panel

The device comes with the following ports on the front panel:

Port	Description
<b>10/100/1000Base-TX) RJ-45 Fast Ethernet ports</b>	4 x 10/100Base-T(X) RJ-45 fast Ethernet ports supporting auto-negotiation.
<b>Gigabit RJ-45 ports</b>	2 x 10/100/1000Base-T Gigabit ports (as combo ports)
<b>Gigabit SFP ports</b>	2 x 100/1000Base-X SFP ports (as combo ports)
<b>Reset button</b>	Press the button for 2 to 3 seconds to reset the switch or 5 seconds to return the switch to factory settings.

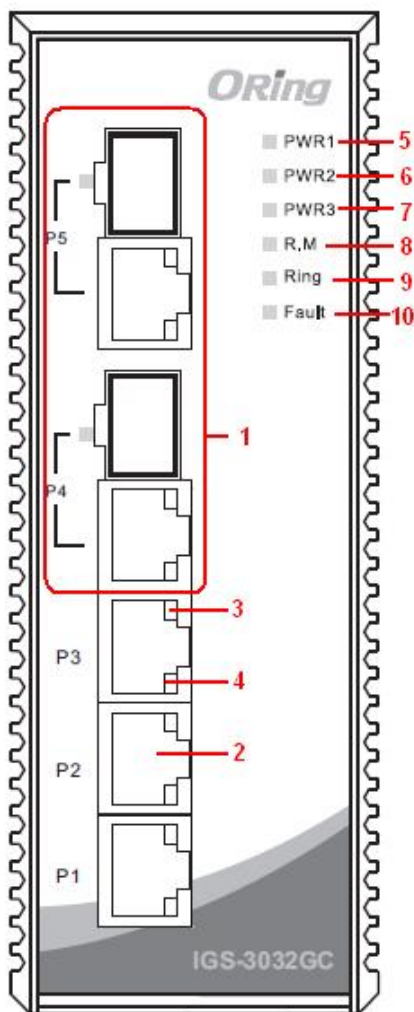

1. Gigabit combo port
2. Gigabit LAN port
3. Link/Act LED for LAN port
4. Speed LED for LAN port
5. Power 1 LED
6. Power 2 LED
7. Power 3 LED
8. R.M status indicator
9. Ring status indicator
10. Fault indicator



## 2.2 Front Panel LEDs

LED	Color	Status	Description
<b>PWR1</b>	Green	On	DC power module 1 activated.
<b>PWR2</b>	Green	On	DC power module 2 activated.
<b>PWR3</b>	Green	On	DC power module 3 activated.
<b>R.M</b>	Green	On	System running in Ring Master mode
<b>Ring</b>	Green	On	System running in Ring mode
		Blinking	Ring structure is broken (i.e. part of the ring is disconnected)
<b>Fault</b>	Amber	On	Faulty relay (power failure or port malfunctioning)
10/100/1000Base-T(X) Fast Ethernet ports			
<b>LNK / ACT</b>	Green	On	Port is linked
		Blinking	Transmitting data
<b>Speed</b>	Amber	On	Port link at 100M speed
Gigabit Combo Ports			
<b>LNK / ACT</b>	Green	On	Port is linked
		Blinking	Transmitting data

## 2.3 Bottom Panel

The device contains the following components on its top panel.

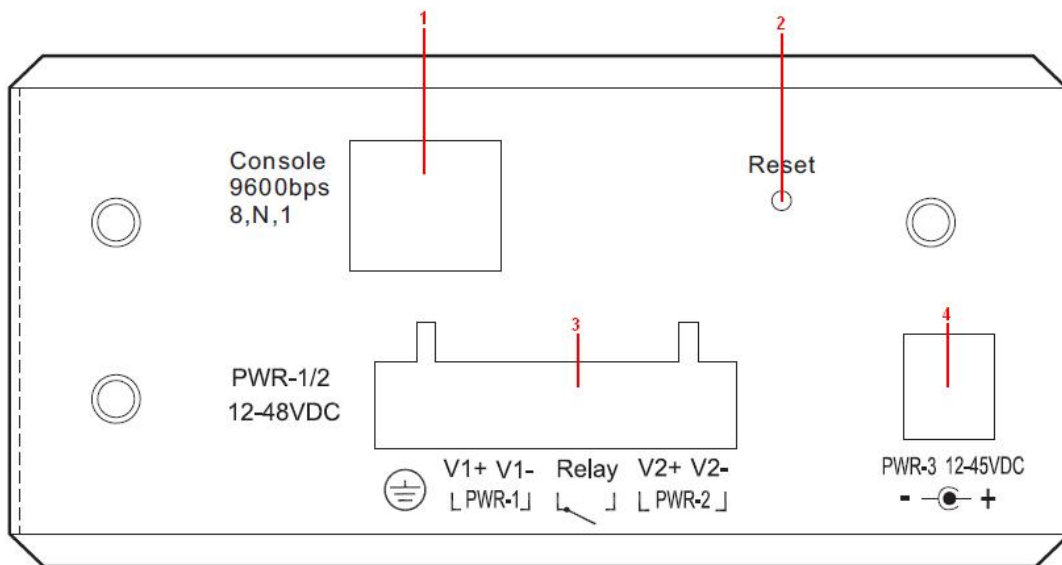

1. Console port
2. Reset button
3. Terminal block
4. Power 3 connector

## 2.4 Rear Panel

On the rear panel of the switch sit three sets of screw holes. The two sets placed in triangular patterns on both ends of the rear panel are used for wall-mounting (red boxes in the figure below) and the set of three holes in the middle are used for Din-rail installation (blue box in the figure below).

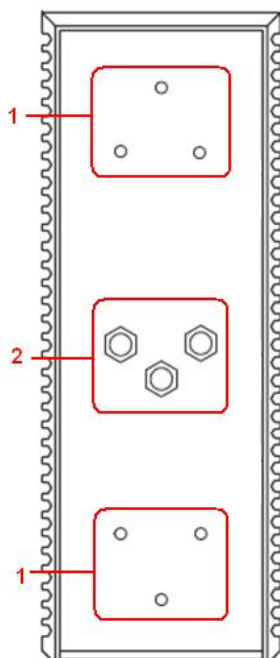

1. Wall-mount screw holes
2. Din-rail screw holes

# Hardware Installation

## 3.1 DIN-rail Installation

The switch comes with a DIN-rail kit which can be installed on the rear panel. With the DIN-rail kit, the switch can be fixed on a DIN-rail. Installing the switch on the DIN-rail is easy. First, screw the Din-rail kit onto the back of the switch, right in the middle of the back panel. Then slide the switch onto a DIN-rail from the Din-rail kit and make sure the switch clicks into the rail firmly.

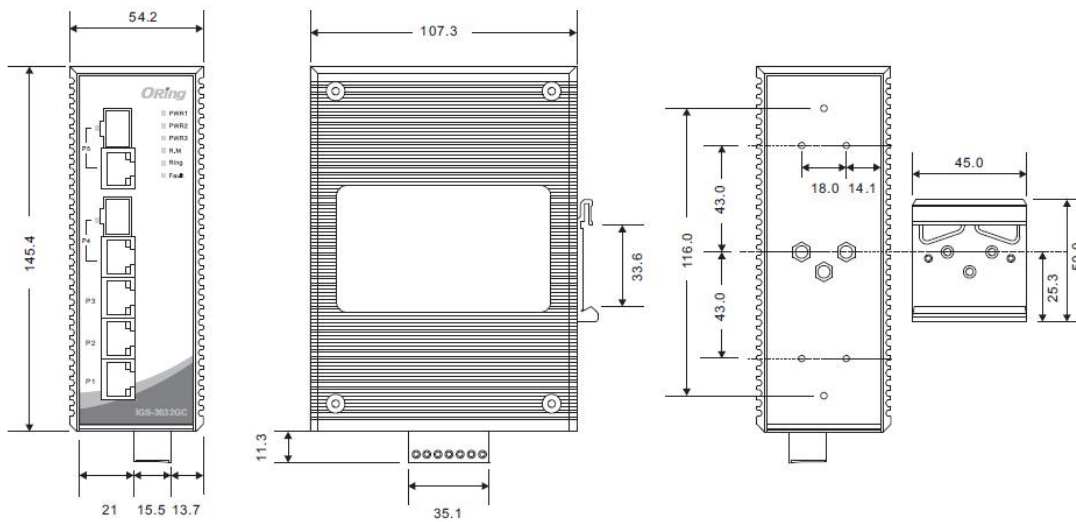

Din-rail Kit Measurement (Unit = mm)

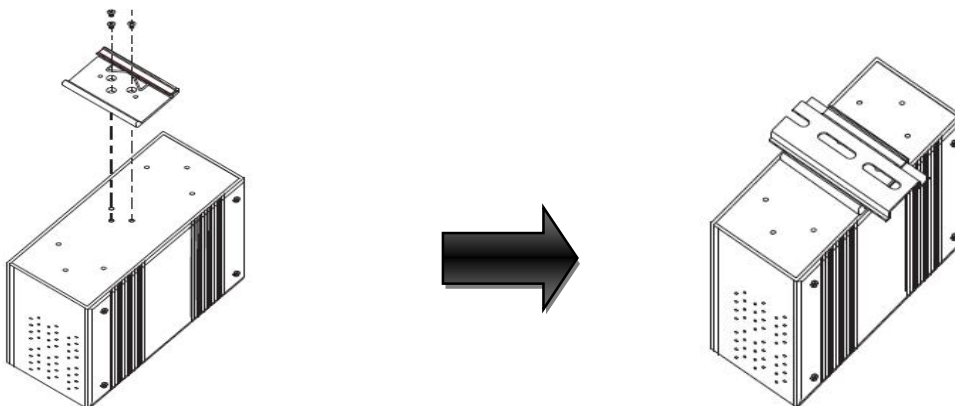

### 3.2 Wall Mounting

Besides Din-Rail, the switch can be fixed to the wall via a wall mount panel, which can be found in the package.

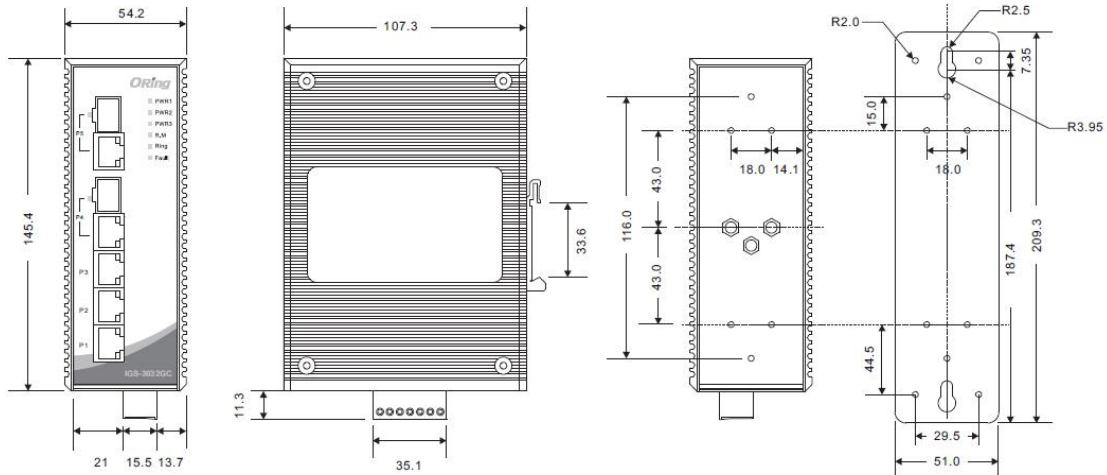

Wall-Mount Kit Measurement (Unit = mm)

To mount the switch onto the wall, follow the steps:

1. Screw the two pieces of wall-mount kits onto both ends of the rear panel of the switch. A total of six screws are required, as shown below.

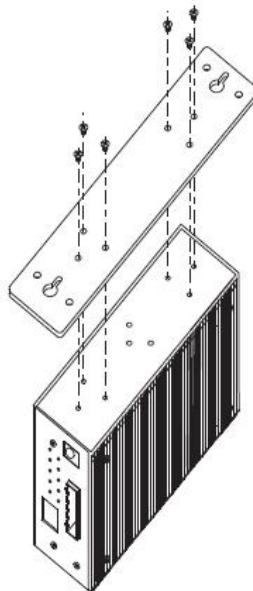

2. Use the switch, with wall mount plates attached, as a guide to mark the correct locations of the four screws.

3. Insert screws through the round screw holes (the red arrow as below) on the sides or through the cross-shaped aperture (the green arrow as below) in the middle of the plate and fasten the screw to the wall with a screwdriver.
4. If the screw goes through the cross-shaped aperture, slide the switch down before tightening the screw.

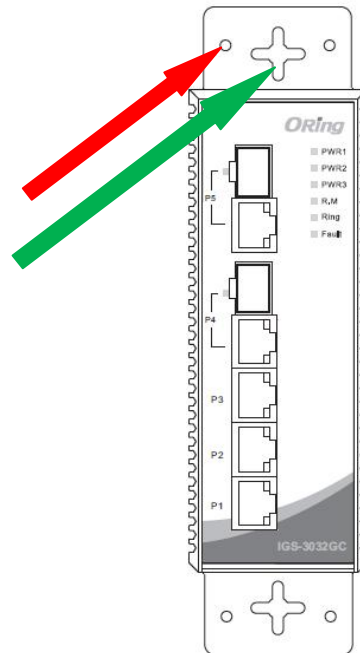

Note: Instead of screwing the screws in all the way, leave about 2 mm to allow room for sliding the wall mount panel between the wall and the screws.

### 3.3 Wiring



#### WARNING

Do not disconnect modules or wires unless power has been switched off or the area is known to be non-hazardous. The devices may only be connected to the supply voltage shown on the type plate.



#### ATTENTION

1. Be sure to disconnect the power cord before installing and/or wiring your switches.
2. Calculate the maximum possible current in each power wire and common wire. Observe all electrical codes dictating the maximum current allowable for each wire size.
3. If the current goes above the maximum ratings, the wiring could overheat, causing serious damage to your equipment.
4. Use separate paths to route wiring for power and devices. If power wiring and device wiring paths must cross, make sure the wires are perpendicular at the intersection point.
5. Do not run signal or communications wiring and power wiring through the same wire conduit. To avoid interference, wires with different signal characteristics

- should be routed separately.
- 6. You can use the type of signal transmitted through a wire to determine which wires should be kept separate. The rule of thumb is that wiring sharing similar electrical characteristics can be bundled together
- 7. You should separate input wiring from output wiring
- 8. It is advised to label the wiring to all devices in the system

### 3.3.1 Grounding

Grounding and wire routing help limit the effects of noise due to electromagnetic interference (EMI). Run the ground connection from the ground screw on the power module to the grounding surface prior to connecting devices.

### 3.3.2 Fault Relay

The relay contacts on the 7-pin terminal block are used to detect user-configured events. The two wires attached to the fault contacts form an open circuit when a user-configured when an event is triggered. If a user-configured event does not occur, the fault circuit remains closed.

### 3.3.3 Redundant Power Inputs

The switch has two sets of power inputs, power input 1 and power input 2, which sit on the front panel along with LAN ports. Follow the steps below to wire redundant power inputs.

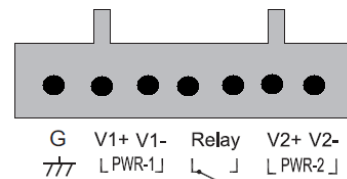

- Step 1: insert the negative/positive wires into the V-/V+ terminals, respectively.
- Step 2: to keep the wires from pulling loose, use a small flat-blade screwdriver to tighten the wire-clamp screws on the front of the terminal block connector.

## 3.4 Connection

### 3.4.1 Cables

The switch has standard Ethernet ports. According to the link type, the switch uses CAT 3, 4, 5,5e UTP cables to connect to any other network devices (PCs, servers, switches, routers, or hubs). Please refer to the following table for cable specifications.

Cable Types and Specifications

Cable	Type	Max. Length	Connector
10BASE-T	Cat.3, 4, 5 100-ohm	UTP 100 m (328 ft)	RJ-45
100BASE-TX	Cat.5 100-ohm UTP	UTP 100 m (328 ft)	RJ-45
1000BASE-TX	Cat.5/Cat.5e 100-ohm UTP	UTP 100 m (328ft)	RJ-45

With 10/100/1000BASE-T(X) cables, pins 1 and 2 are used for transmitting data, and pins 3 and 6 are used for receiving data.

10/100Base-T RJ-45 Pin Assignments:

Pin Number	Assignment
1	TD+
2	TD-
3	RD+
4	Not used
5	Not used
6	RD-
7	Not used
8	Not used

1000Base-T RJ-45 Pin Assignments :

Pin Number	Assignment
1	BI_DA+
2	BI_DA-
3	BI_DB+
4	BI_DC+
5	BI_DC-
6	BI_DB-
7	BI_DD+
8	BI_DD-

The switch also supports auto MDI/MDI-X operation. You can use a cable to connect the switch to a PC. The table below shows the 10BASE-T/ 100BASE-TX MDI and MDI-X port pin outs.

10/100 Base-T MDI/MDI-X Pin Assignments:

Pin Number	MDI port	MDI-X port
1	TD+(transmit)	RD+(receive)
2	TD-(transmit)	RD-(receive)
3	RD+(receive)	TD+(transmit)
4	Not used	Not used

5	Not used	Not used
6	RD-(receive)	TD-(transmit)
7	Not used	Not used
8	Not used	Not used

1000 Base-T MDI/MDI-X Pin Assignments:

Pin Number	MDI port	MDI-X port
1	BI_DA+	BI_DB+
2	BI_DA-	BI_DB-
3	BI_DB+	BI_DA+
4	BI_DC+	BI_DD+
5	BI_DC-	BI_DD-
6	BI_DB-	BI_DA-
7	BI_DD+	BI_DC+
8	BI_DD-	BI_DC-

Note: "+" and "-" signs represent the polarity of the wires that make up each wire pair.

### RS-232 console port wiring

The device can be managed via console ports using a RS-232 cable which can be found in the package. You can connect the port to a PC via the RS-232 cable with a DB-9 female connector. The DB-9 female connector of the RS-232 cable should be connected the PC while the other end of the cable (RJ-45 connector) should be connected to the console port of the switch.

PC pin out (male) assignment	RS-232 with DB9 female connector	DB9 to RJ 45
Pin #2 RD	Pin #2 TD	Pin #2
Pin #3 TD	Pin #3 RD	Pin #3
Pin #5 GD	Pin #5 GD	Pin #5

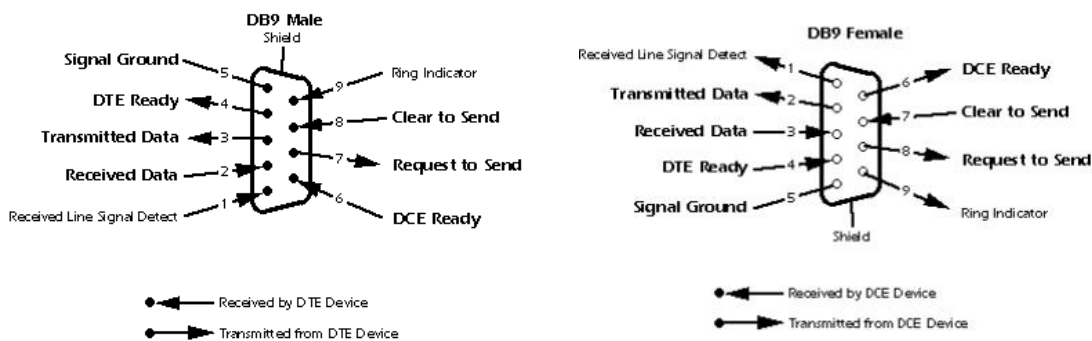



### 3.4.2 SFP

The switch comes with fiber optical ports that can connect to other devices using SFP modules. The fiber optical ports are in multi-mode (0 to 550M, 850 nm with 50/125 μm, 62.5/125 μm fiber) and single-mode with LC connectors. Please remember that the TX port of Switch A should be connected to the RX port of Switch B.

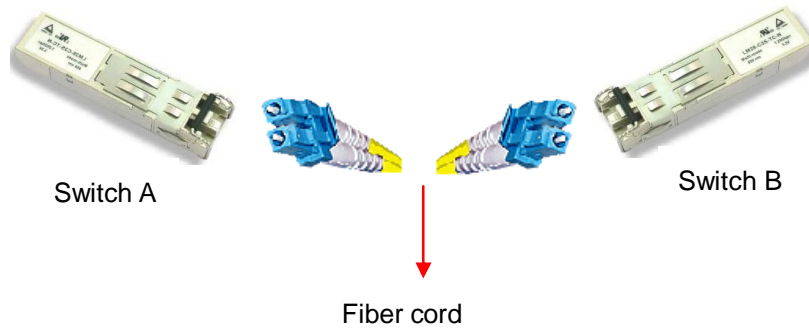

### 3.4.3 O-Ring/O-Chain

#### O-Ring

You can connect three or more switches to form a ring topology to gain network redundancy capabilities through the following steps.

1. Connect each switch to form a daisy chain using an Ethernet cable.
2. Set one of the connected switches to be the master and make sure the port setting of each connected switch on the management page corresponds to the physical ports connected. For information about the port setting, please refer to [4.1.2 Configurations](#).
3. Connect the last switch to the first switch to form a ring topology.

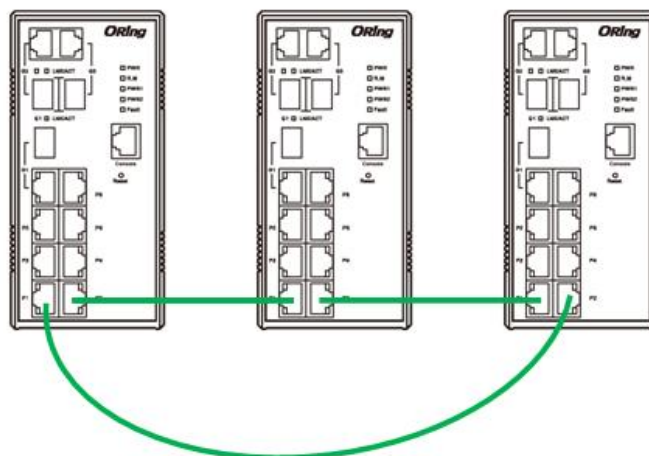

#### Coupling Ring

If you already have two O-Ring topologies and would like to connect the rings, you can form

them into a coupling ring. All you need to do is select two switches from each ring to be connected, for example, switch A and B from Ring 1 and switch C and D from ring 2. Decide which port on each switch to be used as the coupling port and then link them together, for example, port 1 of switch A to port 2 of switch C and port 1 of switch B to port 2 of switch D. Then, enable Coupling Ring option by checking the checkbox on the management page and select the coupling ring in correspondance to the connected port. For more information on port setting, please refer to [4.1.2 Configurations](#). Once the setting is completed, one of the connections will act as the main path while the other will act as the backup path.

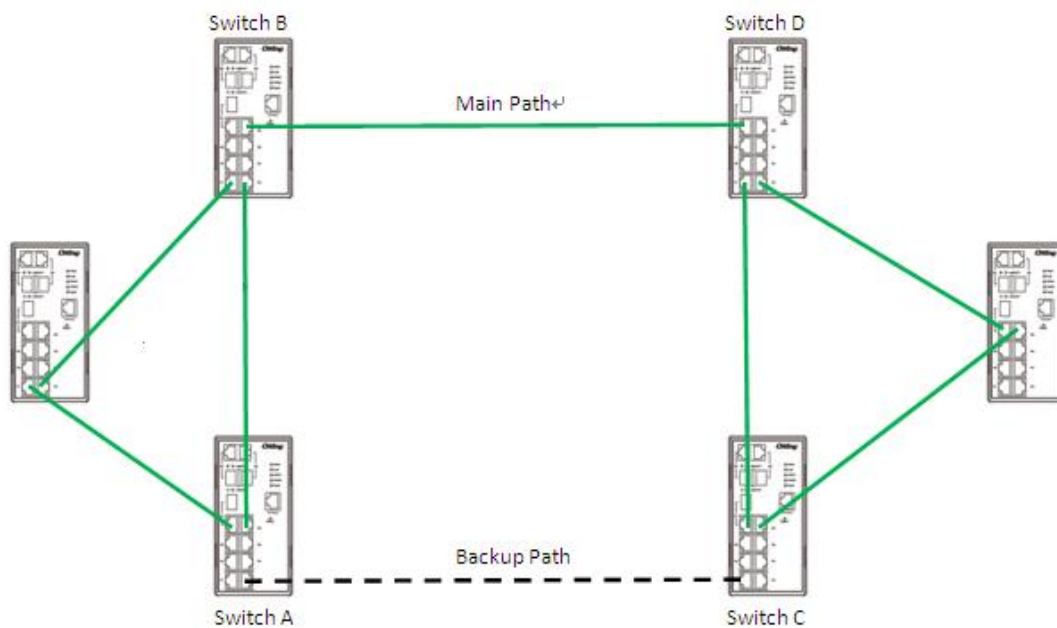

## Dual Homing

If you want to connect your ring topology to a RSTP network environment, you can use dual homing. Choose two switches (Switch A & B) from the ring for connecting to the switches in the RSTP network (core switches). The connection of one of the switches (Switch A or B) will act as the primary path, while the other will act as the backup path that is activated when the primary path connection fails.

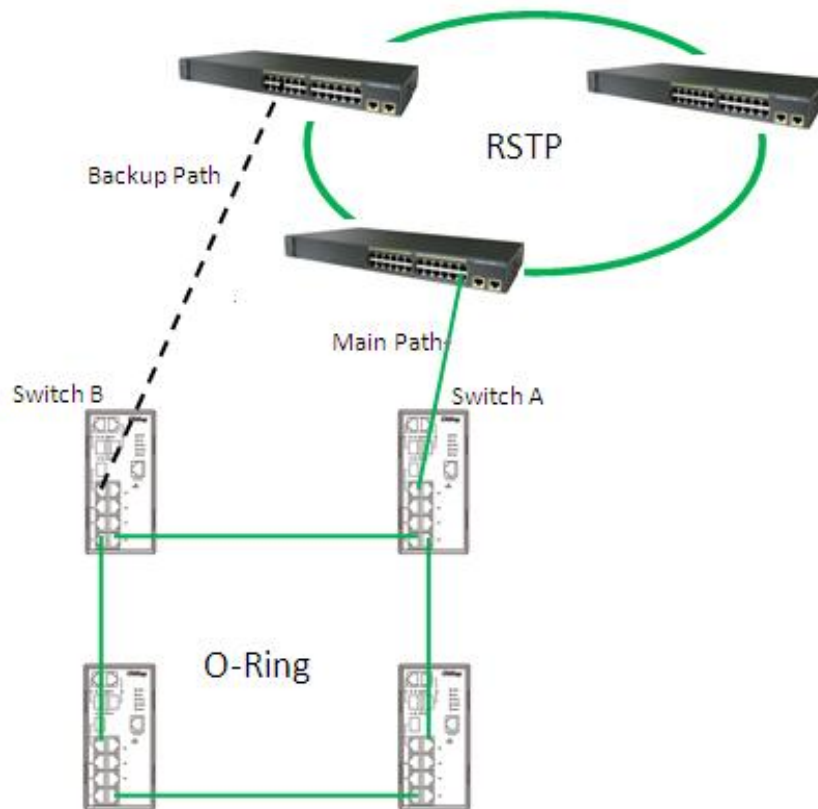

## O-Chain

When connecting multiple O-Rings to meet your expansion demand, you can create an O-Chain topology through the following steps.

1. Select two switches from the chain (Switch A & B) that you want to connect to the O-Ring and connect them to the switches in the ring (Switch C & D).
2. In correspondence to the port connected to the ring, configure an edge port for both of the connected switches in the chain by checking the box in the management page (see [4.1.2 Configurations](#)).
3. Once the setting is completed, one of the connections will act as the main path, and the other as the back up path.

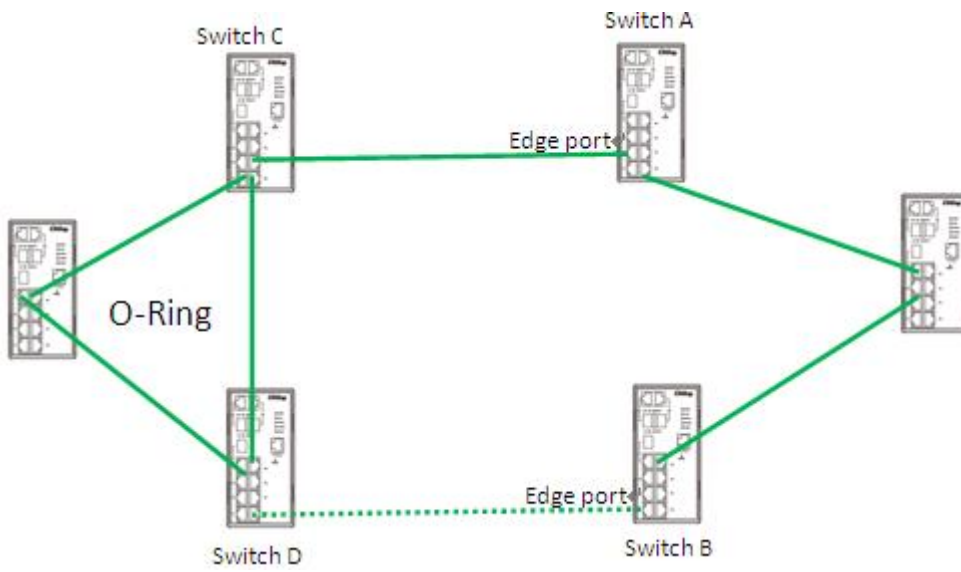

# Redundancy

Redundancy for minimized system downtime is one of the most important concerns for industrial networking devices. Hence, ORing has developed proprietary redundancy technologies including O-Ring and Open-Ring featuring faster recovery time than existing redundancy technologies widely used in commercial applications, such as STP, RSTP, and MSTP. ORing's proprietary redundancy technologies not only support different networking topologies, but also assure the reliability of the network.

## 4.1 O-Ring

### 4.1.1 Introduction

O-Ring is ORing's proprietary redundant ring technology, with recovery time of less than 30 milliseconds (in full-duplex Gigabit operation) or 10 milliseconds (in full-duplex Fast Ethernet operation) and up to 250 nodes. The ring protocols identify one switch as the master of the network, and then automatically block packets from traveling through any of the network's redundant loops. In the event that one branch of the ring gets disconnected from the rest of the network, the protocol automatically readjusts the ring so that the part of the network that was disconnected can reestablish contact with the rest of the network. The O-Ring redundant ring technology can protect mission-critical applications from network interruptions or temporary malfunction with its fast recover technology.

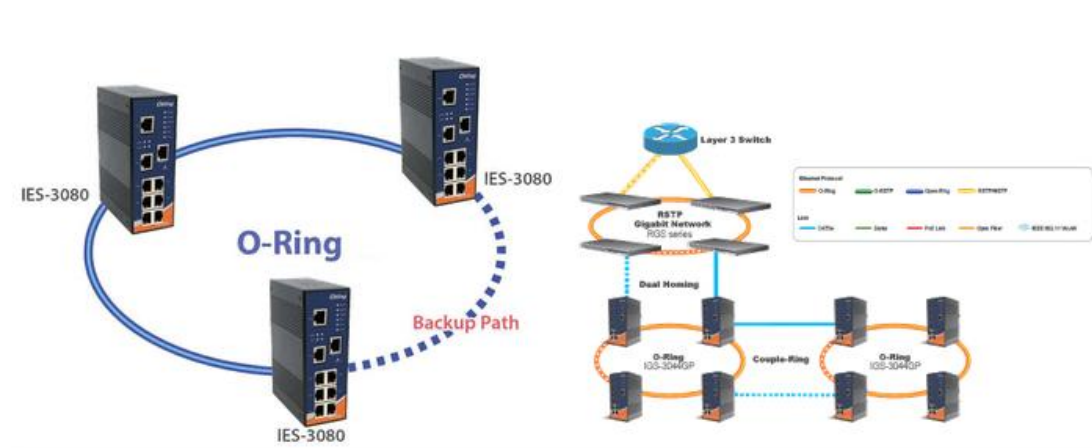

### 4.1.2 Configurations

O-Ring supports three ring topologies: **Ring Master**, **Coupling Ring**, and **Dual Homing**. You can configure the settings in the interface below.

**O-Ring**

<input checked="" type="checkbox"/> <b>Enable Ring</b>		
<input type="checkbox"/> <b>Enable Ring Master</b>		
<b>1st Ring Port</b>	Port.01 ▼	LINKDOWN
<b>2nd Ring Port</b>	Port.02 ▼	LINKDOWN
<input type="checkbox"/> <b>Enable Couple Ring</b>		
<b>Couple Port</b>	Port.03 ▼	LINKDOWN
<input type="checkbox"/> <b>Enable Dual Homing</b>		
<b>Homing Port</b>	Port.05 ▼	LINKDOWN

Apply Help

Label	Description
<b>Enable Ring</b>	Check to enable O-Ring topology.
<b>Enable Ring Master</b>	Only one ring master is allowed in a ring. However, if more than one switches are set to enable <b>Ring Master</b> , the switch with the lowest MAC address will be the active ring master and the others will be backup masters.
<b>1st Ring Port</b>	The primary port when the switch is ring master
<b>2nd Ring Port</b>	The backup port when the switch is ring master
<b>Enable Coupling Ring</b>	Check to enable <b>Coupling Ring</b> . <b>Coupling Ring</b> can divide a big ring into two smaller rings to avoid network topology changes affecting all switches. It is a good method for connecting two rings.
<b>Couple Port</b>	Ports for connecting multiple rings. A coupling ring needs four switches to build an active and a backup link.  Links formed by the coupling ports will run in active/backup mode.
<b>Enable Dual Homing</b>	Check to enable <b>Dual Homing</b> . When <b>Dual Homing</b> is enabled, the ring will be connected to normal switches through two RSTP links (ex: backbone Switch). The two links work in active/backup mode, and connect each ring to the normal switches in RSTP mode.
<b>Apply</b>	Click to activate the configurations.

**Note:** due to heavy loading, setting one switch as ring master and coupling ring at the same time is not recommended.

## 4.2 Open-Ring

### 4.2.1 Introduction

Open-Ring is a technology developed by ORing to enhance ORing switches' interoperability with other vendors' products. With this technology, you can add any ORing switches to the network based on other ring technologies.

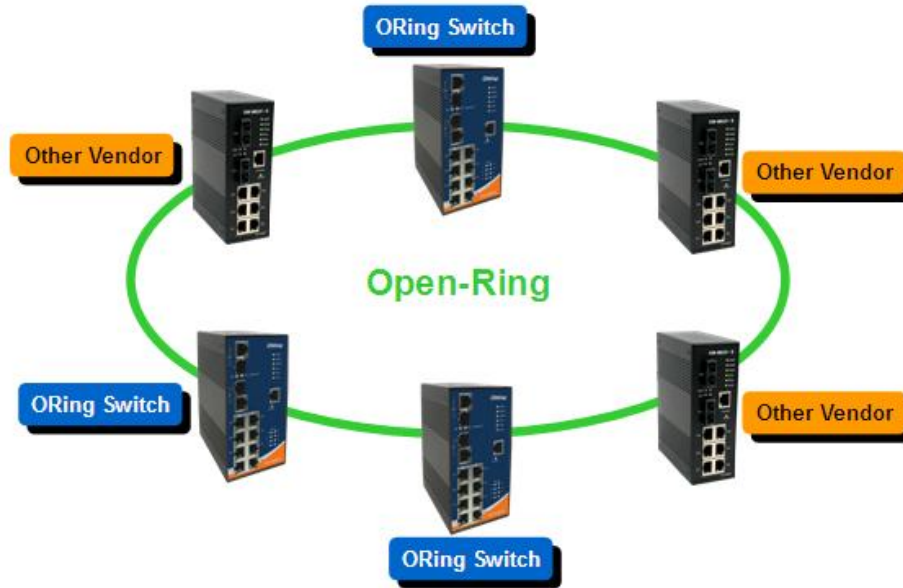

### 4.2.2 Configurations

#### Open-Ring

<input checked="" type="checkbox"/> <b>Enable</b>	
<b>Vender</b>	Moxx <span style="float: right;">▼</span>
<b>1st Ring Port</b>	Port.01 <span style="float: right;">▼</span>
<b>2nd RingPort</b>	Port.02 <span style="float: right;">▼</span>

Label	Description
<b>Enable</b>	Check to enable Open-Ring topology
<b>Vender</b>	Choose the vendors that you want to join in their rings
<b>1<sup>st</sup> Ring Port</b>	The first port to connect to the ring
<b>2<sup>nd</sup> Ring Port</b>	The second port to connect to the ring

## 4.3 O-Chain

### 4.3.1 Introduction

O-Chain is ORing's revolutionary network redundancy technology which enhances network redundancy for any backbone networks, providing ease-of-use and maximum fault-recovery swiftness, flexibility, compatibility, and cost-effectiveness in a set of network redundancy topologies. The self-healing Ethernet technology designed for distributed and complex industrial networks enables the network to recover in less than 30 milliseconds (in full-duplex Gigabit operation) or 10 milliseconds (in full-duplex Fast Ethernet operation) for up to 250 switches if at any time a segment of the chain fails.

O-Chain allows multiple redundant rings of different redundancy protocols to join and function together as a large and the most robust network topologies. It can create multiple redundant networks beyond the limitations of current redundant ring technologies.

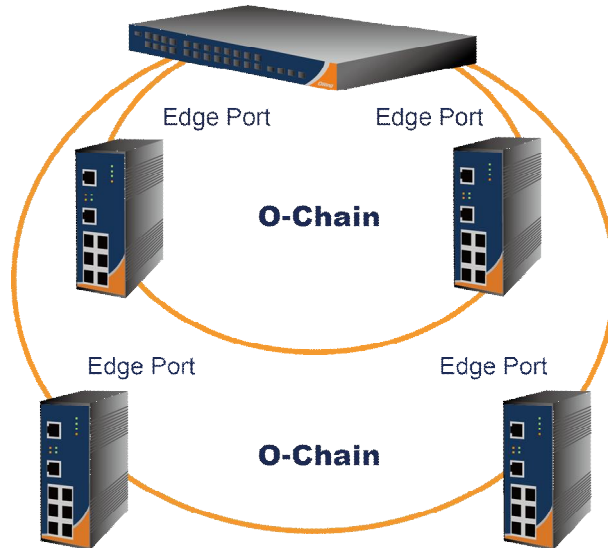

### 4.3.2 Configurations

O-Chain is very easy to configure and manage. Only one edge port of the edge switch needs to be defined. Other switches beside them just need to have O-Chain enabled.

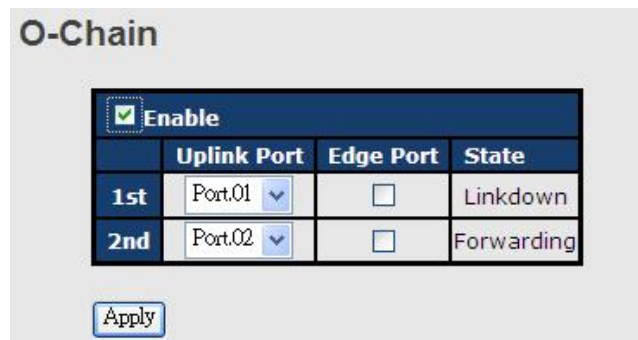



Label	Description
<b>Enable</b>	Check to enable O-Chain function
<b>1<sup>st</sup> Ring Port</b>	The first port connecting to the ring
<b>2<sup>nd</sup> Ring Port</b>	The second port connecting to the ring
<b>Edge Port</b>	An O-Chain topology must begin with edge ports. The ports with a smaller switch MAC address will serve as the backup link and RM LED will light up.

## 4.4 MRP

### 4.4.1 Introduction

MRP (Media Redundancy Protocol) is an industry standard for high-availability Ethernet networks. MRP allowing Ethernet switches in ring configuration to recover from failure rapidly to ensure seamless data transmission. A MRP ring (IEC 62439) can support up to 50 devices and will enable a back-up link in 80ms (adjustable to max. 200ms/500ms).

### 4.4.2 Configurations

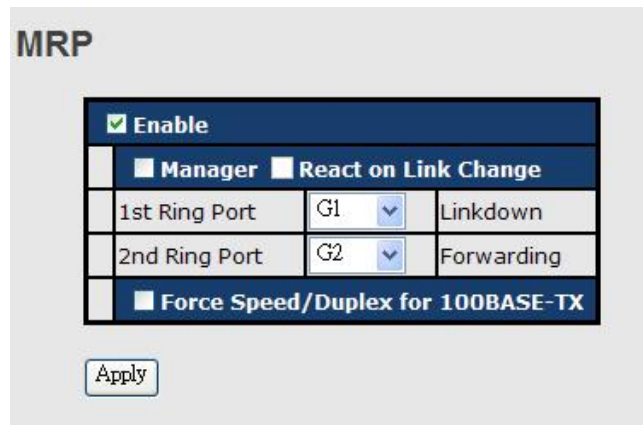

Label	Description
<b>Enable</b>	Enables the MRP function
<b>Manager</b>	Every MRP topology needs a MRP manager. One MRP topology can only have a Manager. If two or more switches are set to be Manager, the MRP topology will fail.
<b>React on Link Change (Advanced mode)</b>	Faster mode. Enabling this function will cause MRP topology to converge more rapidly. This function only can be set in MRP manager switch.
<b>1<sup>st</sup> Ring Port</b>	Chooses the port which connects to the MRP ring
<b>2<sup>nd</sup> Ring Port</b>	Chooses the port which connects to the MRP ring

<p><b>Force Speed / Duplex for 100BASE-TX</b></p>	<p>By default, this is in auto-negotiation mode. Enabling this function will automatically change the default to <b>Full</b> mode.(this function is used in combination with Hirschmann's switch as the MRP ring port speed/duplex of Hirschmann's switches are always in <b>Full</b> mode)</p>
---	---

## 4.5 STP/RSTP/MSTP

### 4.5.1 STP/RSTP

STP (Spanning Tree Protocol), and its advanced versions RSTP (Rapid Spanning Tree Protocol) and MSTP (Multiple Spanning Tree Protocol), are designed to prevent network loops and provide network redundancy. Network loops occur frequently in large networks as when two or more paths run to the same destination, broadcast packets may get in to an infinite loop and hence causing congestion in the network. STP can identify the best path to the destination, and block all other paths. The blocked links will stay connected but inactive. When the best path fails, the blocked links will be activated. Compared to STP which recovers a link in 30 to 50 seconds, RSTP can shorten the time to 5 to 6 seconds. In other words, RSTP provides faster spanning tree convergence after a topology changes. The switch supports STP and will auto detect the connected device running on STP or RSTP protocols.

### RSTP Repeater

A repeater can pass a BPDU packet directly from one RSTP device to another as if the two devices are connected.

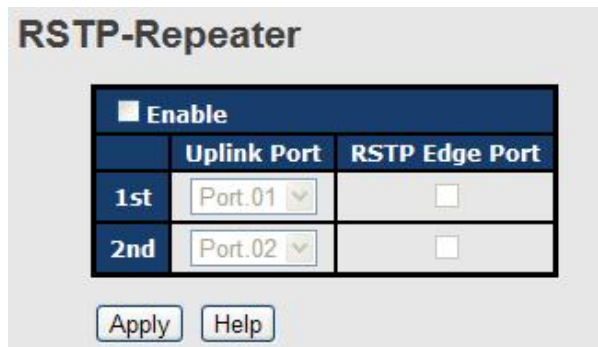

Label	Description
<b>Enable</b>	Check to enable RSTP Repeater
<b>1<sup>st</sup> Ring Port</b>	The first port connecting to the RSTP network
<b>2<sup>nd</sup> Ring Port</b>	The second port connecting to the RSTP network
<b>Edge Port</b>	Only the edge device (connected to RSTP device) needs to

	specify edge port. The user must specify the edge port according to topology of network.
--	--

**RSTP Bridge Setting**

### RSTP - Bridge Setting

<b>RSTP Mode</b>	Enable <input type="button" value="v"/>
<b>Priority (0-61440)</b>	<input type="text" value="32768"/>
<b>Max Age (6-40)</b>	<input type="text" value="20"/>
<b>Hello Time (1-10)</b>	<input type="text" value="2"/>
<b>Forward Delay Time (4-30)</b>	<input type="text" value="15"/>

**Priority must be a multiple of 4096.  
2\*(Forward Delay Time-1) should be greater than or equal to the Max Age.  
The Max Age should be greater than or equal to 2\*(Hello Time + 1).**

Label	Description
<b>RSTP mode</b>	You must enable or disable RSTP function before configuring the related parameters.
<b>Priority (0-61440)</b>	A value used to identify the root bridge. The bridge with the lowest value has the highest priority and is selected as the root. If the value changes, you must reboot the switch. The value must be a multiple of 4096 according to the protocol standard rule
<b>Max Age Time(6-40)</b>	The number of seconds a bridge waits without receiving Spanning-tree Protocol configuration messages before attempting a reconfiguration. The valid value is between 6 through 40.
<b>Hello Time (1-10)</b>	The time interval a switch sends out the BPDU packet to check RSTP current status. The time is measured in seconds and the valid value is between 1 through 10.
<b>Forwarding Delay Time (4-30)</b>	The time of a port waits before changing from RSTP learning and listening states to forwarding state. The valid value is between 4 through 30.
<b>Apply</b>	Click to apply the configurations.

**NOTE:** the calculation of the MAX Age, Hello Time, and Forward Delay Time is as follows:  
 $2 \times (\text{Forward Delay Time value} - 1) \geq \text{Max Age value} \geq 2 \times (\text{Hello Time value} + 1)$

The following pages show the information of the root bridge, including its port status.

### Root Bridge Information

<b>Bridge ID</b>	8000001E94011E7A
<b>Root Priority</b>	32768
<b>Root Port</b>	ROOT
<b>Root Path Cost</b>	0
<b>Max Age</b>	20
<b>Hello Time</b>	2
<b>Forward Delay</b>	15

### RSTP - Port Setting

Port	Path Cost (1-200000000)	Priority (0-240)	Admin P2P	Admin Edge	Admin Non Stp
Port.01					
Port.02					
Port.03	200000	128	auto	true	false
Port.04					
Port.05					

**priority must be a multiple of 16**

Apply Help

### Port Status

Port	Path Cost	Port Priority	Oper P2P	Oper Edge	Stp Neighbor	State	Role
Port.01	200000	128	True	True	False	Disabled	Disabled
Port.02	200000	128	True	True	False	Disabled	Disabled
Port.03	200000	128	True	True	False	Disabled	Disabled
Port.04	200000	128	True	True	False	Disabled	Disabled
Port.05	200000	128	True	True	False	Disabled	Disabled

Label	Description
<b>Path Cost</b> (1-200000000)	The path cost incurred by the port. The path cost is used when establishing an active topology for the network. Lower path cost ports are chosen as forwarding ports in favor of higher path cost ports. The range of valid values is 1 to 200000000.

<b>Port Priority (0-240)</b>	Decide which port should be blocked by priority in the LAN. The valid value is between 0 and 240, and must be a multiple of 16
<b>Oper P2P</b>	Configures the port connects to a point-to-point LAN rather than a shared medium. This can be configured automatically or set to true or false manually. True means P2P enabling. False means P2P disabling. Transiting to forwarding state is faster for point-to-point LANs than for shared media.
<b>Oper Edge</b>	A flag indicating whether the port is connected directly to edge devices or not (no bridges attached). Transiting to the forwarding state is faster for edge ports (operEdge set to true) than other ports.
<b>STP Neighbor</b>	The port uses mathematical calculations according to STP. <b>True</b> means not included in mathematical calculations, and <b>False</b> means contained in mathematical calculations according to STP.
<b>State</b>	Determines the STP state of the port
<b>Role</b>	When enabled, the port will not be selected as root port for CIST or any MSTI, even if it has the best spanning tree priority vector. Such a port will be selected as an alternate port after the root port has been selected. If set, spanning trees will lose connectivity. It can be set by a network administrator to prevent bridges outside a core region of the network from influencing the active spanning tree topology because those bridges are not under the full control of the administrator. This feature is also known as Root Guard.
<b>Apply</b>	Click to apply the configurations.

## 4.5.2 MSTP

Since the recovery time of STP and RSTP takes seconds, which is unacceptable in industrial applications, MSTP was developed. The technology supports multiple spanning trees within a network by grouping and mapping multiple VLANs into different spanning-tree instances, known as MSTIs, to form individual MST regions. Each switch is assigned to an MST region. Hence, each MST region consists of one or more MSTP switches with the same VLANs, at least one MST instance, and the same MST region name. Therefore, switches can use different paths in the network to effectively balance loads.

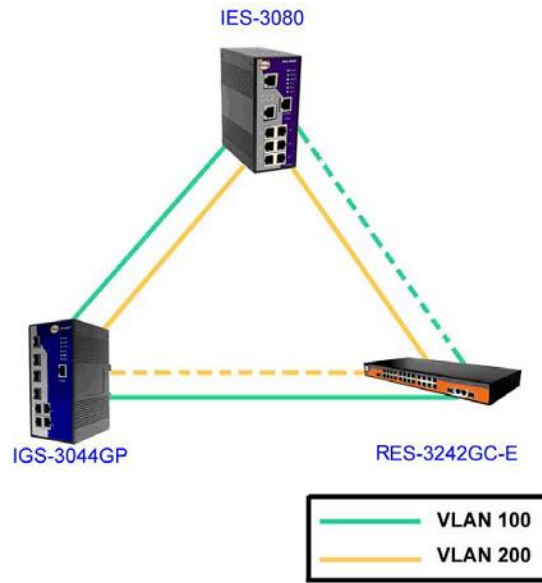

### Bridge Settings

This page allows you to examine and change the configurations of current MSTI ports. A MSTI port is a virtual port, which is instantiated separately for each active CIST (physical) port for each MSTI instance configured and applicable for the port. The MSTI instance must be selected before MSTI port configuration options are displayed.

**MSTP - Bridge Setting**

<b>MSTP Enable</b>	Enable <input type="button" value="v"/>
<b>Force Version</b>	MSTP <input type="button" value="v"/>
<b>Configuration Name</b>	MSTP_SWITCH
<b>Revision Level (0-65535)</b>	0
<b>Priority (0-61440)</b>	32768
<b>Max Age Time (6-40)</b>	20
<b>Hello Time (1-10)</b>	2
<b>Forward Delay Time (4-30)</b>	15
<b>Max Hops (1-40)</b>	20

Priority must be a multiple of 4096.  
 2\*(Forward Delay Time-1) should be greater than or equal to the Max Age.  
 The Max Age should be greater than or equal to 2\*(Hello Time + 1).

Label	Description
<b>MSTP Enable</b>	Enables or disables MSTP function.
<b>Force Version</b>	Forces a VLAN bridge that supports RSTP to operate in an STP-compatible manner.

<b>Configuration Name</b>	The name which identifies the VLAN to MSTI mapping. Bridges must share the name and revision (see below), as well as the VLAN-to-MSTI mapping configurations in order to share spanning trees for MSTIs (intra-region). The name should not exceed 32 characters.
<b>Revision Level (0-65535)</b>	Revision of the MSTI configuration named above. This must be an integer between 0 and 65535.
<b>Priority (0-61440)</b>	A value used to identify the root bridge. The bridge with the lowest value has the highest priority and is selected as the root. If the value changes, you must reboot the switch. The value must be a multiple of 4096 according to the protocol standard rule.
<b>Max Age Time(6-40)</b>	The number of seconds a bridge waits without receiving Spanning-tree Protocol configuration messages before attempting a reconfiguration. The valid value is between 6 through 40.
<b>Hello Time (1-10)</b>	The time interval a switch sends out the BPDU packet to check RSTP current status. The time is measured in seconds and the valid value is between 1 through 10.
<b>Forwarding Delay Time (4-30)</b>	The time of a port waits before changing from RSTP learning and listening states to forwarding state. The valid value is between 4 through 30.
<b>Max Hops (1-40)</b>	An additional parameter for those specified for RSTP. A single value applies to all STP within an MST region (the CIST and all MSTIs) for which the bridge is the regional root.
<b>Apply</b>	Click to apply the configurations.

**Bridge Port**

**MSTP - Bridge Port**

Port No.	Priority (0-240)	Path Cost (1-200000000, 0:Auto)	Admin P2P	Admin Edge	Admin Non Stp
Port.01					
Port.02					
Port.03	128	0	auto	true	false
Port.04					
Port.05					

**priority must be a multiple of 16**

Apply

Label	Description
Port No.	The number of port you want to configure
Priority (0-240)	Decide which port should be blocked by priority in the LAN. The valid value is between 0 and 240, and must be a multiple of 16.
Path Cost (1-200000000)	The path cost incurred by the port. The path cost is used when establishing an active topology for the network. Lower path cost ports are chosen as forwarding ports in favor of higher path cost ports. The range of valid values is 1 to 200000000.
Admin P2P	Configures whether the port connects to a point-to-point LAN rather than a shared medium. This can be configured automatically or set to true or false manually. True means P2P enabling. False means P2P disabling. Transitioning to forwarding state is faster for point-to-point LANs than for shared media.
Admin Edge	Specify whether this port is an edge port or a nonedge port. An edge port is not connected to any other bridge. Only edge ports and point-to-point links can rapidly transition to forwarding state. To configure the port as an edge port, set the port to True.
Admin Non STP	The port includes the STP mathematic calculation. True is not including STP mathematic calculation, false is including the STP mathematic calculation.
Apply	Click to apply the configurations.

### Instance Setting

This page allows you to change the configurations of current MSTI bridge instance.

#### MSTP - Instance Setting

Instance	State	VLANs	Priority (0-61440)
1 <input type="button" value="v"/>	Enable <input type="button" value="v"/>	1-4094	32768

**Priority must be a multiple of 4096.**

Label	Description
Instance	Set the instance from 1 to 15
State	Enables or disables the instance
VLANs	The VLAN which is mapped to the MSTI. A VLAN can only be



	mapped to one MSTI. An unused MSTI will be left empty (ex. without any mapped VLANs).
<b>Priority (0-61440)</b>	A value used to identify the root bridge. The bridge with the lowest value has the highest priority and is selected as the root. If the value changes, you must reboot the switch. The value must be a multiple of 4096 according to the protocol standard
<b>Apply</b>	Click to apply the configurations.

### Port Priority

This page allows you to change the configurations of current MSTI bridge instance priority.

#### MSTP - Instance Port

Instance: CIST ▼

Port	Priority (0-240)	Path Cost (1-200000000, 0:Auto)
<div style="border: 1px solid #ccc; padding: 2px;">                     Port.01 <span style="float: right;">▲</span>                      Port.02 <span style="float: right;">☰</span>                      Port.03 <span style="float: right;">▼</span>                      Port.04 <span style="float: right;">▼</span>                      Port.05 <span style="float: right;">▼</span> </div>	<input style="width: 60px; border: 1px solid #ccc;" type="text" value="128"/>	<input style="width: 60px; border: 1px solid #ccc;" type="text" value="0"/>

**Priority must be a multiple of 16**

Apply

Label	Description
<b>Instance</b>	The bridge instance. CIST is the default instance, which is always active.
<b>Port</b>	The port number which you want to configure.
<b>Priority (0-240)</b>	Decides the priority of ports to be blocked in the LAN. The valid value is between 0 and 240, and must be a multiple of 16
<b>Path Cost (1-200000000)</b>	The path cost incurred by the port. The path cost is used when establishing an active topology for the network. Lower path cost ports are chosen as forwarding ports in favor of higher path cost ports. The range of valid values is 1 to 200000000.
<b>Apply</b>	Click to apply the configurations.

## 4.6 Fast Recovery

Fast recovery mode can be set to connect multiple ports to one or more switches, thereby

providing redundant links. Fast recovery mode supports 5 priorities. Only the first priority will be the active port, and the other ports with different priorities will be backup ports.

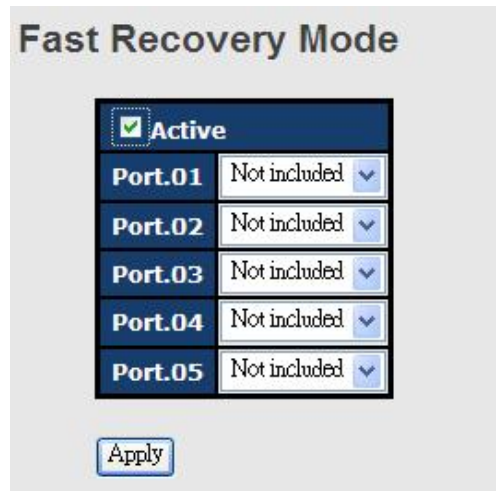

Label	Description
<b>Active</b>	Activate fast recovery mode
<b>Port.01 - 05</b>	Ports can be set to 5 priorities. Only the port with the highest priority will be the active port. 1st Priority is the highest.
<b>Apply</b>	Click to activate the configurations.

# Management

The switch can be controlled via a built-in web server which supports Internet Explorer (Internet Explorer 5.0 or above versions) and other Web browsers such as Chrome. Therefore, you can manage and configure the switch easily and remotely. You can also upgrade firmware via a Web browser. The Web management function not only reduces network bandwidth consumption, but also enhances access speed and provides a user-friendly viewing screen.

**Note:** By default, IE5.0 or later version do not allow Java applets to open sockets. You need to modify the browser setting separately in order to enable Java applets for network ports.

## Management via Web Browser

Follow the steps below to manage your switch via a Web browser

### System Login

1. Launch an Internet Explorer.
2. Type `http://` and the IP address of the switch. Press **Enter**.

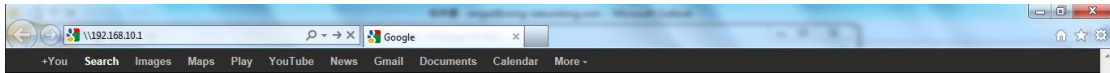

3. A login screen appears.
4. Type in the username and password. The default username and password is **admin**.
5. Press **Enter** or click **OK**, the management page appears.



Note: you can use the following default values:

IP Address: **192.168.10.1**

Subnet Mask: **255.255.255.0**

Default Gateway: **192.168.10.254**

User Name: **admin**

Password: **admin**

After logging in, you will see the information of the switch as below.

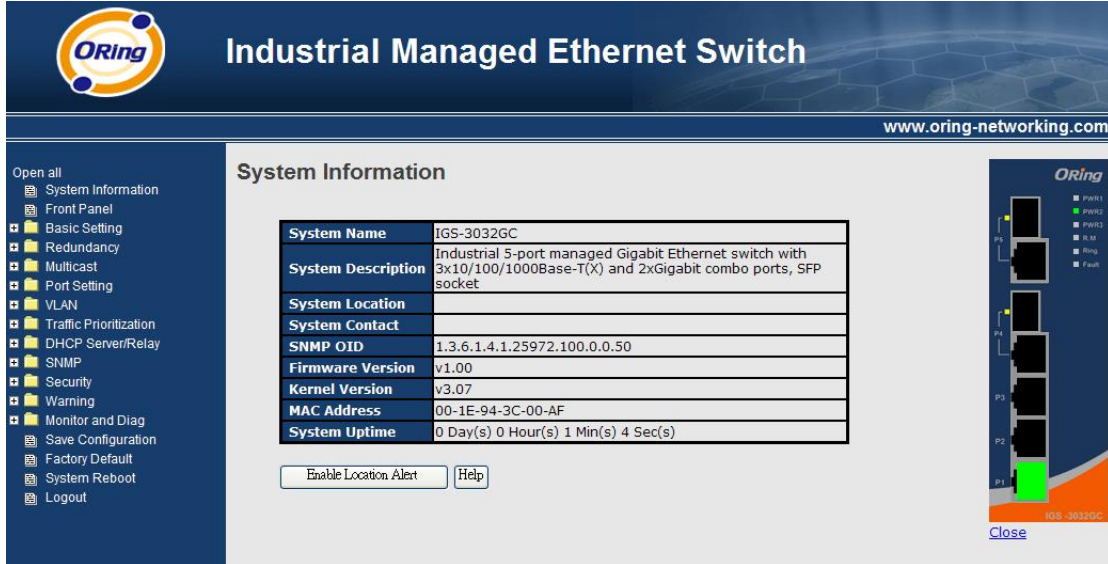

On the left hand side of the management interface shows links to various settings. Clicking on the links will bring you to individual configuration pages. On the right hand side shows the picture of the front device whose indicators correspond to the physical device.

## 5.1 Basic Settings

The Basic Settings page allows you to configure the basic functions of the switch.

### 5.1.1 System Information

This page shows the general information of the switch.

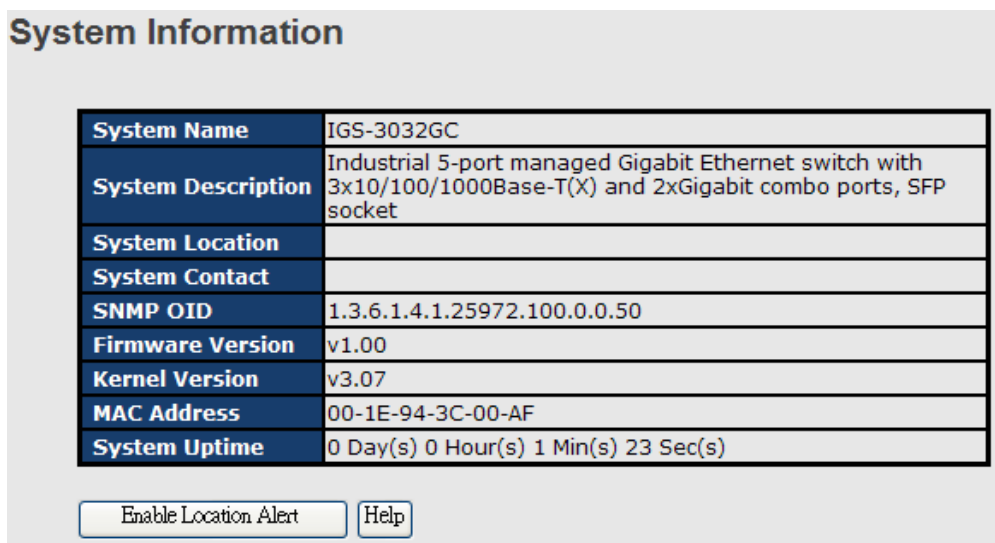

Label	Description
<b>System Name</b>	An administratively assigned name for the managed node. By convention, this is the node's fully-qualified domain name. A domain name is a text string consisting of alphabets (A-Z, a-z), digits (0-9), and minus sign (-). Space is not allowed to be part of the name. The first character must be an alpha character. And the first or last character must not be a minus sign. The allowed string length is 0 to 255.
<b>System Description</b>	Description of the device
<b>System Location</b>	The physical location of the node (e.g., telephone closet, 3rd floor). The allowed string length is 0 to 255, and only ASCII characters from 32 to 126 are allowed.
<b>System Contact</b>	The textual identification of the contact person for this managed node, together with information on how to contact this person. The allowed string length is 0 to 255, and only ASCII characters from 32 to 126 are allowed.
<b>System Timezone offset(minutes)</b>	Provides the time-zone offset from UTC/GMT. The offset is given in minutes east of GMT. The valid range is from -720 to 720 minutes.
<b>Save</b>	Click to save changes.
<b>Reset</b>	Click to undo any changes made locally and revert to previously saved values.

### 5.1.2 System Setting

You can provide details about the device in the following page.

#### System Setting

<b>System Name</b>	IGS-3032GC
<b>System Description</b>	Industrial 5-port managed Gigabit Ethernet switch with 3x10/100/1000Base-T(X) and 2xGigabit e
<b>System Location</b>	
<b>System Contact</b>	

Label	Description
<b>System Name</b>	Assigns a name to the switch. The maximum length is 64 bytes.

<b>System Description</b>	Displays the description of the switch.
<b>System Location</b>	Specifies the physical location of the switch. The maximum length is 64 bytes.
<b>System Contact</b>	Enter the name of a contact person or organization

### 5.1.3 Admin & Password

This page allows you to configure the system password required to access the web pages or log in from CLI.

The screenshot shows a web interface titled "Admin Password". It contains three rows of labels and input fields: "User Name" with the value "admin", "New Password" (empty), and "Confirm Password" (empty). At the bottom, there are two buttons: "Apply" and "Help".

Label	Description
<b>User name</b>	The user name for operating the switch (default is <b>admin</b> )
<b>New Password</b>	The new system password (default is <b>admin</b> )
<b>Confirm password</b>	Re-type the new password
<b>Apply</b>	Click to save changes

### 5.1.4 IP Setting

This page allows you to configure IP information for the switch. You can configure the settings manually by disabling DHCP Client. After inputting the values, click **Apply** and the new values will be applied.

The screenshot shows a web interface titled "IP Setting". At the top, there is a "DHCP Client" dropdown menu currently set to "Disable". Below this is a table with five rows of labels and input fields: "IP Address" (192.168.10.1), "Subnet Mask" (255.255.255.0), "Gateway" (192.168.10.254), "DNS1" (0.0.0.0), and "DNS2" (0.0.0.0). At the bottom, there are two buttons: "Apply" and "Help".

Label	Description
<b>DHCP Client</b>	Enables or disables the DHCP client. If DHCP fails or the configured IP address is zero, DHCP will retry. If DHCP retry fails, DHCP will stop trying and the configured IP settings will be used.
<b>IP Address</b>	Assigns the IP address of the network in use. If DHCP client function is enabled, you do not need to assign the IP address. The network DHCP server will assign an IP address to the switch and it will be displayed in this column. The default IP is <b>192.168.10.1</b> .
<b>Subnet Mask</b>	Assigns the subnet mask of the IP address. If DHCP client function is enabled, you do not need to assign the subnet mask.
<b>Gateway</b>	Assign the network gateway for the switch. The default gateway is 192.168.10.254.
<b>DNS1</b>	Assign the primary DNS IP address
<b>DNS2</b>	Assign the secondary DNS IP address
<b>Apply</b>	Click to apply the changes

### 5.1.5 Time Setting

This page allows you to configure SNTP and system clock.

#### System Clock

The system clock synchronizes the tasks in a computer, like loading data before manipulating it.

The screenshot shows a web interface titled "Time Setting" with a sub-section "System Clock". It contains three rows of configuration fields:

- System Clock**: Thu Jan 01 1970 00:39:12 GMT+0800 (台北標準時間)
- System Date (YYYY/MM/DD)**: 2012, Jun, 22
- System Time (hh:mm:ss)**: 15 : 43 : 42

Below the fields are three buttons: "Apply", "Set Clock From PC", and "Help".

Label	Description
<b>System Clock</b>	Shows the current system time. The time stamp could be assigned manually configuration or automatically by a SNTP server.
<b>System Date</b>	Specifies the year, month and day of the system clock

	(YYYY/MM/DD). Year: 2006-2015. Month: Jan-Dec. Day:1-31(28)
<b>System Time</b>	Specify the hour, minute and second of the system clock (hh:mm:ss). Hour:0-24, Minute:0-59, Second:0-59

**SNTP**

SNTP (Simple Network Time Protocol) is a protocol able to synchronize the time on your system to the clock on the Internet. It will synchronize your computer system time with a server that has already been synchronized by a source such as a radio, satellite receiver or modem.

SNTP Client :  ▾

<b>UTC Timezone</b>	<input type="text" value="(GMT)Greenwich Mean Time: Dublin, Edinburgh, Lisbon, London"/> ▾
<b>SNTP Server Address</b>	<input type="text" value="0.0.0.0"/>

Daylight Saving Time :  ▾

<b>Daylight Saving Period</b>	<input type="text" value="2012"/> <input type="text" value="Jun"/> ▾ <input type="text" value="22"/> ▾ <input type="text" value="07"/> ▾         ~
<b>Daylight Saving Offset</b>	<input type="text" value="0"/> (hours)

Label	Description
<b>SNTP Client</b>	Enables or disables SNTP function to retrieve the time from a SNTP server.
<b>UTC Time zone</b>	Selects the time zone for the switch according to its location
<b>SNTP Sever Address</b>	Enters the SNTP server IP address which you would like to use for time synchronization.
<b>Daylight Saving Time</b>	Enables or disables daylight saving time function. When it is enabled, you need to configure the daylight saving time period.
<b>Daylight Saving Period</b>	Configures the beginning and ending time for the daylight saving option. The values will vary each year.
<b>Daylight Saving Offset</b>	Configures the offset time.
<b>Apply</b>	Click to apply the changes

The following table lists different location time zones for your reference.



Local Time Zone	Conversion from UTC	Time at 12:00 UTC
November Time Zone	- 1 hour	11 am
Oscar Time Zone	-2 hours	10 am
ADT - Atlantic Daylight	-3 hours	9 am
AST - Atlantic Standard EDT - Eastern Daylight	-4 hours	8 am
EST - Eastern Standard CDT - Central Daylight	-5 hours	7 am
CST - Central Standard MDT - Mountain Daylight	-6 hours	6 am
MST - Mountain Standard PDT - Pacific Daylight	-7 hours	5 am
PST - Pacific Standard ADT - Alaskan Daylight	-8 hours	4 am
ALA - Alaskan Standard	-9 hours	3 am
HAW - Hawaiian Standard	-10 hours	2 am
Nome, Alaska	-11 hours	1 am
CET - Central European FWT - French Winter MET - Middle European MEWT - Middle European Winter SWT - Swedish Winter	+1 hour	1 pm
EET - Eastern European, USSR Zone 1	+2 hours	2 pm
BT - Baghdad, USSR Zone 2	+3 hours	3 pm
ZP4 - USSR Zone 3	+4 hours	4 pm
ZP5 - USSR Zone 4	+5 hours	5 pm
ZP6 - USSR Zone 5	+6 hours	6 pm
WAST - West Australian Standard	+7 hours	7 pm
CCT - China Coast, USSR Zone 7	+8 hours	8 pm
JST - Japan Standard, USSR Zone 8	+9 hours	9 pm
EAST - East Australian Standard GST Guam Standard, USSR Zone 9	+10 hours	10 pm
IDLE - International Date Line NZST - New Zealand Standard NZT - New Zealand	+12 hours	Midnight

### PTP Client

The Precision Time Protocol (PTP) is a time-transfer protocol defined in the IEEE 1588-2002 standard that allows precise synchronization of networks (e.g., Ethernet). Accuracy within the nanosecond range can be achieved with this protocol when using hardware generated timestamps.



Label	Description
<b>PTP Client</b>	Enables or disables PTP Client

### 5.1.6 LLDP

LLDP (Link Layer Discovery Protocol) provides a method for networked devices to receive and/or transmit their information to other connected devices on the network that are also using the protocols, and to store the information that is learned about other devices. This page allows you to examine and configure current LLDP port settings.

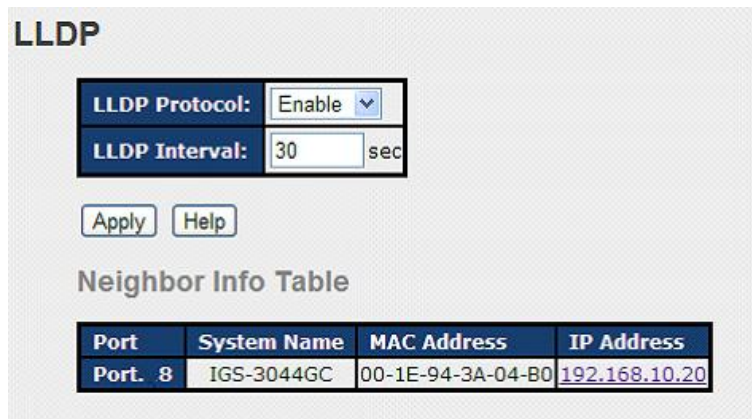

Label	Description
<b>LLDP Protocol</b>	Enables or disables LLDP function.
<b>LLDP Interval</b>	The interval of resending LLDP ( 30 seconds by default)
<b>Apply</b>	Click to apply the configurations.
<b>Help</b>	Shows help file.
<b>Neighbor info table</b>	Shows neighbor device info, including system name, MAC address, and IP address.

### 5.1.7 Modbus TCP

Modbus TCP uses TCP/IP and Ethernet to carry the data of the Modbus message structure between compatible devices. The protocol is commonly used in SCADA systems for communications between a human-machine interface (HMI) and programmable logic controllers. This page enables you to enable and disable Modbus TCP support of the switch.



Label	Description
<b>Mode</b>	Enables or disables Modbus TCP function

### 5.1.8 Auto Provision

Auto Provision allows you to update switch firmware automatically. You can put the firmware or configuration file on a TFTP server. When you reboot the switch, it will upgrade firmware automatically. Before updating, make sure you have your TFTP server ready and the firmware image and configuration files are on the TFTP server.

#### Auto Provision

Auto install configuration file from TFTP server?

<b>TFTP Server IP Address</b>	192.168.10.66
<b>Configuration File Name</b>	data.bin

Auto install firmware image file from TFTP server?

<b>TFTP Server IP Address</b>	192.168.10.66
<b>Firmware File Name</b>	image.bin

### 5.1.9 Backup & Restore

You can save current values from the switch to a TFTP server, and restore the switch to the settings by going to the TFTP restore configuration page.

The following page allows you to save the existing configurations as a backup file to a TFTP server.

#### Restore Configuration

From TFTP Server

<b>TFTP Server IP Address</b>	192.168.10.2
<b>Restore File Name</b>	data.bin

From Local PC

The following page allows you to restore the system to previous configurations from a TFTP server.

Label	Description
<b>TFTP Server IP Address</b>	The IP address of the TFTP where you put the configuration file or where you want to restore the switch to previous settings.
<b>Backup File Name</b>	The name of the configuration file you want to save as.
<b>Restore File Name</b>	The name of the configuration file you want to use for the switch.
<b>Backup</b>	Click to back up the configurations.
<b>To Local PC</b>	You can save the configuration file to your PC instead of a TFTP server.
<b>Restore</b>	Click to restore the configurations.
<b>Form Local PC</b>	You can use the file stored on a local PC instead of from the TFTP server. Click <b>Browse</b> to locate the file you want to use for update, and then click <b>Restore</b> .

### 5.1.10 Upgrade Firmware

This page allows you to update the firmware of the switch. Before updating, make sure you have your TFTP server ready and the firmware file is on the TFTP server. Enter the IP address of the TFTP server you want to connect to and the firmware file name, and then click upgrade to start upgrading. You can also choose the firmware file form your PC.

### Upgrade Firmware

From TFTP Server

<b>TFTP Server IP</b>	192.168.10.2
<b>Firmware File Name</b>	image.bin

From Local PC

## 5.2 Multicast

### 5.2.1 IGMP Snooping

IGMP (Internet Group Management Protocol) snooping monitors the IGMP traffic between hosts and multicast routers. The switch uses what IGMP snooping learns to forward multicast traffic only to interfaces that are connected to interested receivers. This conserves bandwidth by allowing the switch to send multicast traffic to only those interfaces that are connected to hosts that want to receive the traffic, instead of flooding the traffic to all interfaces in the VLAN. This page allows you to set up IGMP snooping configurations.

### IGMP Snooping

IGMP Snooping :

IGMP Query Mode:

IGMP Snooping Table

IP Address	VLAN ID	Member Port
230.0.0.20	1	Port.07

Label	Description
<b>IGMP Snooping</b>	Check to enable global IGMP snooping

<b>IGMP Query Mode</b>	Configures the switch to be the IGMP querier. Only one IGMP querier is allowed in an IGMP application. <b>Auto</b> will select the switch with the lowest IP address as the querier.
<b>Apply</b>	Click to apply the configurations.
<b>Help</b>	Shows help file.

### 5.2.2 MVR

MVR (Multicast VLAN registration) enables hosts that are not part of a multicast VLAN to receive multicast streams from the multicast VLAN. As a result, the multicast VLAN can be shared across the network and there is no need to send duplicate multicast streams to each requesting VLAN in the network.

**MVR**

MVR Mode: Disable ▾

MVR VLAN:

Port	Type	Immediate Leave
Port.01	Inactive ▾	<input type="checkbox"/>
Port.02	Inactive ▾	<input type="checkbox"/>
Port.03	Inactive ▾	<input type="checkbox"/>
Port.04	Inactive ▾	<input type="checkbox"/>
Port.05	Inactive ▾	<input type="checkbox"/>
Port.06	Inactive ▾	<input type="checkbox"/>
Port.07	Inactive ▾	<input type="checkbox"/>

Label	Description
<b>MVR Mode</b>	Enables or disables MVR
<b>MVR VLAN</b>	The number of MVR VLANs
<b>Type</b>	Indicates the MVR type of the port. <b>Inactive</b> means the port is not participating in any MVR groups.
<b>Immediate Leave</b>	Check to enables immediate leave function. Immediate leave reduces the length of time it takes the switch to stop forwarding multicast traffic when the last member host on the interface leaves the group.

### 5.2.3 Static Multicast Filtering

Static multicast filtering provides a method for users to configure multicast group memberships

manually. The function enables end devices to receive multicast traffic only if they register to join specific multicast groups. With static multicast filtering, network devices only forward multicast traffic to the ports connected to registered end devices. The function allows you to control the multicast traffic precisely.

**Static Multicast Filtering**

Multicast IP Address :

Member Ports :

Port.01  Port.02  Port.03  Port.04  
 Port.05  Port.06  Port.07  Port.08  
 G1  G2

	IP Address	Member Ports
<input type="checkbox"/>	230.0.0.6	Port.04, Port.05

Label	Description
<b>Multicast IP Address</b>	Assigns a multicast group IP address in the range of 224.0.0.0 ~ 239.255.255.255
<b>Member Ports</b>	Check the box next to the port number to include them as member ports in the specific multicast group.
<b>Add</b>	Click to add the ports to the IP multicast list
<b>Delete</b>	Deletes an entry from the table
<b>Help</b>	Shows help file.

### 5.2.4 Port Setting

Port Setting allows you to manage individual ports of the switch, including speed/duplex, flow control, and security.

Port Control

**Port Control**

Port No.	State	Speed/Duplex	Flow Control	Security
G1	Enable ▾	AutoNegotiation ▾	Symmetric ▾	Disable ▾
G2	Enable ▾	AutoNegotiation ▾	Symmetric ▾	Disable ▾
G3	Enable ▾	AutoNegotiation ▾	Symmetric ▾	Disable ▾
G4	Enable ▾	AutoNegotiation ▾	Symmetric ▾	Disable ▾
G5	Enable ▾	AutoNegotiation ▾	Symmetric ▾	Disable ▾

Apply Help

Label	Description
<b>Port NO.</b>	The number of the port to be configured.
<b>State</b>	Enables or disables the port.
<b>Speed/Duplex</b>	Available values include <b>auto-negotiation</b> , <b>100-full</b> , <b>100-half</b> , <b>10-full</b> , or <b>10-half</b>
<b>Flow Control</b>	Supports symmetric and asymmetric modes to avoid packet loss when congestion occurs
<b>Security</b>	Enabling port security will disable MAC address learning in this port. Thus only the frames with MAC addresses in the port security list will be forwarded, otherwise will be discarded.
<b>Apply</b>	Click to apply the configurations

5.2.5 Port Status

This page shows the status of the each port in terms of its state, speed/duplex, and flow control.

**Port Status**

Port No.	Type	Link	State	Speed/Duplex	Flow Control
Port.01	100TX	Down	Enable	N/A	N/A
Port.02	100TX	Down	Enable	N/A	N/A
Port.03	100TX	Down	Enable	N/A	N/A
Port.04	100TX	Down	Enable	N/A	N/A

5.2.6 Port Alias

This page provides alias IP address configuration. Some devices might have more than one IP



addresses. You could specify other IP addresses here.

**Port Alias**

Port No.	Port Alias
Port.01	
Port.02	
Port.03	
Port.04	
Port.05	

### 5.2.7 Rate Limit

This page allows you to define the rate limits applied to a port, including incoming and outgoing traffic.

**Rate Limit**

Port No.	Ingress Limit Frame Type	Ingress	Egress
Port.01	All	0 kbps	0 kbps
Port.02	All	0 kbps	0 kbps
Port.03	All	0 kbps	0 kbps
Port.04	All	0 kbps	0 kbps
Port.05	All	0 kbps	0 kbps
Port.06	All	0 kbps	0 kbps
Port.07	All	0 kbps	0 kbps
Port.08	All	0 kbps	0 kbps
G1	All	0 kbps	0 kbps
G2	All	0 kbps	0 kbps

Note: rate range is from 100 kbps to 102400 kbps (i.e. 100Mbps) for mega-ports, or 256000 kbps (i.e. 250Mbps) for giga-ports. Zero means no limit.

Label	Description
<b>Ingress Limit Frame Type</b>	Valid values include <b>All</b> , <b>Broadcast only</b> , <b>Broadcast/Multicast</b> and <b>Broadcast/Multicast/Flooded Unicast</b> .
<b>Ingress</b>	The transmission rate for incoming traffic
<b>Egress</b>	The transmission rate for outgoing traffic
<b>Apply</b>	Click to activate the configurations.

### 5.2.8 Port Trunking

A port trunk is a group of ports that have been grouped together to function as one logical path. This method provides an economical way for you to increase the bandwidth between the switch and another networking device. In addition, it is useful when a single physical link between the devices is insufficient to handle the traffic load. This page allows you to configure the aggregation hash mode and the aggregation group.

**Port Trunk - Setting**

Port No.	Group ID	Type
Port.01	None	Static
Port.02	None	Static
Port.03	None	Static
Port.04	None	Static
Port.05	None	Static
Port.06	None	Static
Port.07	None	Static
Port.08	None	Static
G1	None	Static
G2	None	Static

Note: the types should be the same for all member ports in a group.

802.3ad LACP Work Ports

Group ID	Work Ports
Trunk1	max
Trunk2	max
Trunk3	max
Trunk4	max
Trunk5	max

Apply Help

Label	Description
<b>Group ID</b>	Indicates the ID of each aggregation group. <b>None</b> means no aggregation. Only one group ID is valid per port.
<b>Type</b>	The switch supports two types of link aggregation; static and 802.3ad LACP. Static trunks are manually configured, while LACP-configured ports will automatically negotiate a trunk with LACP-configured ports on another device.

<b>Work Ports</b>	The total number of active ports in a dynamic trunk group. The default value of works ports is <b>Max</b> . In a dynamic trunk group, if the number of work ports is lower than the number of members of the trunk group, the exceed ports are standby/redundant ports and can be aggregated if working ports fail. If it is a static trunk group, the number of work ports must equal the total number of group member ports.
<b>Apply</b>	Click to activate the configurations.

### Port Trunk - Status

Group ID	Trunk Member	Type
Trunk 1	N/A	Static
Trunk 2	N/A	Static
Trunk 3	N/A	Static
Trunk 4	N/A	Static
Trunk 5	N/A	Static

Label	Description
<b>Group ID</b>	Indicates the ID of each aggregation group. <b>None</b> means no aggregation. Only one group ID is valid per port.
<b>Trunk Member</b>	Lists members of a specific trunk group.
<b>Type</b>	Indicates the type of the port trunk

## 5.2.9 Loop Guard

This feature prevents loop attack. When receiving loop packets, the port will be disabled automatically, preventing the loop attack from affecting other network devices.

### Loop Guard

Port No.	Active	Port State
Port.01	<input type="checkbox"/>	Enable
Port.02	<input type="checkbox"/>	Enable
Port.03	<input type="checkbox"/>	Enable

Label	Description
<b>Active</b>	Check to enable Loop Guard

<b>Port Status</b>	Indicates the enabled/disabled status of the port.
--------------------	--

## 5.3 VLAN

### 5.3.1 VLAN Setting - IEEE 802.1Q

A VLAN (Virtual LAN) is a logical LAN based on a physical LAN with links that does not consist of a physical (wired or wireless) connection between two computing devices but is implemented using methods of network virtualization. A VLAN can be created by partitioning a physical LAN into multiple logical LANs using a VLAN ID. You can assign switch ports to a VLAN and add new VLANs in this page.

#### VLAN Setting

VLAN Operation Mode :  ▼

GVRP Mode :  ▼

Management VLAN ID :

#### Port VLAN Setting

Port No.	Link Type	PVID	Untagged VIDs	Tagged VIDs
Port.01	Access ▼	1	1	
Port.02	Access ▼	1	1	
Port.03	Access ▼	1	1	

Label	Description
<b>VLAN Operation Mode</b>	Available options include <b>Disable</b> , <b>Port Base</b> , and <b>802.1Q</b>
<b>GVRP Mode</b>	GVRP is a GARP application that provides IEEE 802.1Q-compliant VLAN pruning and dynamic VLAN creation on 802.1Q trunk ports. With GVRP, the switch can exchange VLAN configuration information with other GVRP switches, prune unnecessary broadcast and unknown unicast traffic, and dynamically create and manage VLANs on switches connected through 802.1Q trunk ports.
<b>Management VLAN ID</b>	The VLAN ID for the entry.
<b>Link type</b>	Three link types are available: <b>Access Link:</b> An access link connects a VLAN-unaware device to the port of a VLAN-aware bridge. All frames on access links must be implicitly tagged (untagged).

	<p><b>Trunk Link:</b> All the devices connected to a trunk link, including workstations, must be VLAN-aware. All frames on a trunk link must have a special header attached.</p> <p><b>Hybrid Link:</b> The combination of Access Link and Trunk Link. This is a link where both VLAN-aware and VLAN-unaware devices are attached. It can have both tagged and untagged frames, but all the frames for a specific VLAN must be either tagged or untagged.</p> <p><b>Hybrid(QinQ) Link:</b> Allows one more VLAN tag in an original VLAN frame.</p>
<b>Untagged VID</b>	Set the port default VLAN ID for untagged devices that connect to the port. The range is 1 to 4094.
<b>Tagged VIDs</b>	Set the tagged VIDs to carry different VLAN frames to other switch.
<b>Apply</b>	Click to set the configurations.

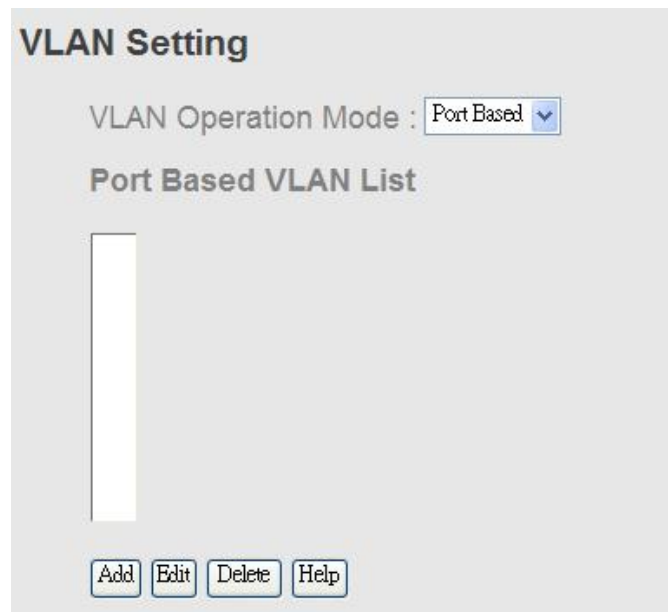

Label	Description
<b>VLAN Operation Mode</b>	Available options include <b>Disable</b> , <b>Port Base</b> , and <b>802.1Q</b>
<b>Add</b>	Click to start adding a VLAN
<b>Edit</b>	Edits existing VLANs
<b>Delete</b>	Deletes existing VLANs
<b>Help</b>	Shows help file.

Label	Description
<b>VLAN Operation Mode</b>	Available options include <b>Disable</b> , <b>Port Base</b> , and <b>802.1Q</b>
<b>Group Name</b>	The name of the VLAN that you want to change settings.
<b>VLAN ID</b>	The number of the VLAN
<b>Add</b>	Select ports from the left column and clicks <b>Add</b> to include them to the VLAN group
<b>Remove</b>	Remove ports from the VLAN group
<b>Apply</b>	Click to apply the configurations
<b>Help</b>	Shows help file.

## 5.4 Traffic Prioritization

With traffic prioritization schemes, the switch can transmit data based on its importance, thereby ensuring mission-critical applications, such as VoIP and video conferencing, have sufficient bandwidth for transmission when the network is congested.

QoS (Quality of Service) is a method to achieve efficient bandwidth utilization between devices by prioritizing frames according to individual requirements and transmit the frames based on their importance. Frames in higher priority queues receive a bigger slice of bandwidth than those in a lower priority queue.

### 5.4.1 QoS Policy

Policing is a traffic regulation mechanism for limiting the rate of traffic streams, thereby controlling the maximum rate of traffic sent or received on an interface. When the traffic rate exceeds the configured maximum rate, policing drops or remarks the excess traffic. This page allows you to configure QoS policies for the switch.

#### Policy

QoS Mode : Disable ▼

QoS Policy :

Use an 8,4,2,1 weighted fair queuing scheme

Use a strict priority scheme

Apply
Help

Label	Description
QoS Mode	Available modes include: <b>Disable:</b> disables the mode <b>Port-base:</b> the output priority is determined by ingress port. <b>COS only:</b> the output priority is determined by COS only. <b>TOS only:</b> the output priority is determined by TOS only. <b>COS first:</b> the output priority is determined by COS and TOS, but COS first. <b>TOS first:</b> the output priority is determined by COS and TOS, but TOS first.
QoS policy	<b>Using the 8,4,2,1 weight fair queue scheme:</b> the output queues will use an 8:4:2:1 ratio to transmit packets from the highest to lowest queue. For example: 8 high queue packets, 4 middle queue packets, 2 low queue packets, and the one lowest queue packets are transmitted in one turn. <b>Use the strict priority scheme:</b> when traffic arrives at the device, traffic on the highest priority queue will be transmitted first, followed by traffic on lower priorities. If there is always some content in the highest priority queue, then the other packets in the rest of queues will not be sent until the highest priority queue is empty.
<b>Apply</b>	Click to apply the configurations
<b>Help</b>	Shows help file.

### 5.4.2 Port-base Priority

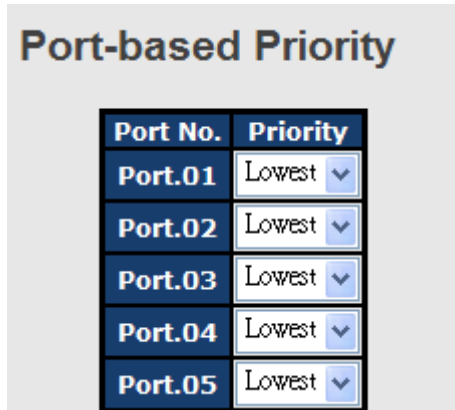

Label	Description
<b>Priority</b>	Assigns a port to a priority queue. Four priority queues are available: <b>High</b> , <b>Middle</b> , <b>Low</b> , and <b>Lowest</b> .
<b>Apply</b>	Click to apply the configurations
<b>Help</b>	Shows help file.

### 5.4.3 COS/802.1p

COS (Class of Service), also known as 802.1p, is a parameter for differentiating the types of payloads contained in the packet to be transmitted. CoS operates only on 802.1Q VLAN Ethernet at Layer 2, while other QoS mechanisms operate at the Layer 3 or use a local QoS tagging system that does not modify the actual packet. COS supports up to 7 priorities and 4 priority queues: High, Middle, Low, and Lowest. When an ingress packet has no VLAN tag, the default priority value will be used.

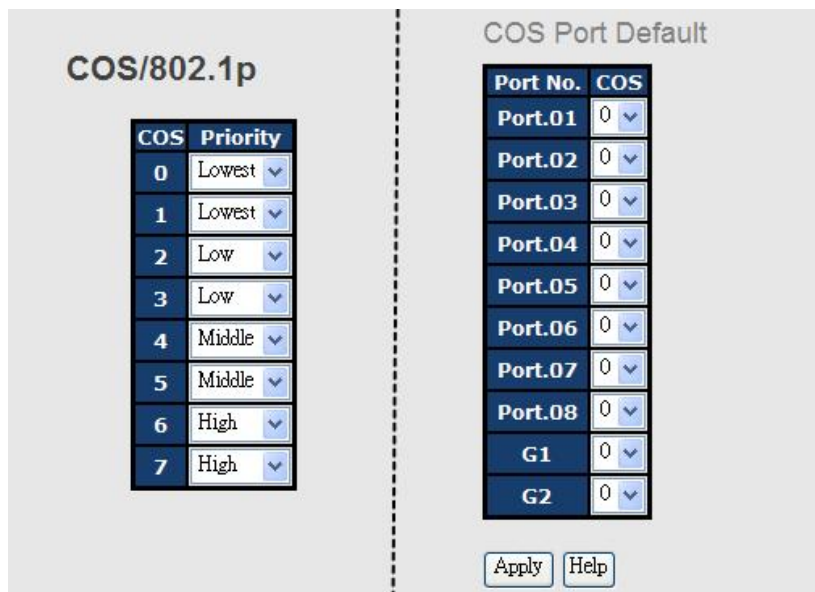



Label	Description
<b>Priority</b>	Assigns a port to a priority queue. Four priority queues are available: <b>High</b> , <b>Middle</b> , <b>Low</b> , and <b>Lowest</b> .
<b>Apply</b>	Click to apply the configurations
<b>Help</b>	Shows help file.

### 5.4.4 TOS/DSCP

TOS (Type of Service) is a field in the IP header of a packet. It is used by Differentiated Services and is called the DSCP (Differentiated Services Code Point). The output priority of a packet can be determined by this field and the supported priority value ranges from 0 to 63. DSCP supports four priority queues: High, Middle, Low, and Lowest.

**TOS/DSCP**

<b>DSCP</b>	<b>0</b>	<b>1</b>	<b>2</b>	<b>3</b>	<b>4</b>	<b>5</b>	<b>6</b>	<b>7</b>
<b>Priority</b>	Lowest ▾	Lowest ▾	Lowest ▾	Lowest ▾	Lowest ▾	Lowest ▾	Lowest ▾	Lowest ▾
<b>DSCP</b>	<b>8</b>	<b>9</b>	<b>10</b>	<b>11</b>	<b>12</b>	<b>13</b>	<b>14</b>	<b>15</b>
<b>Priority</b>	Lowest ▾	Lowest ▾	Lowest ▾	Lowest ▾	Lowest ▾	Lowest ▾	Lowest ▾	Lowest ▾
<b>DSCP</b>	<b>16</b>	<b>17</b>	<b>18</b>	<b>19</b>	<b>20</b>	<b>21</b>	<b>22</b>	<b>23</b>
<b>Priority</b>	Low ▾	Low ▾	Low ▾	Low ▾	Low ▾	Low ▾	Low ▾	Low ▾
<b>DSCP</b>	<b>24</b>	<b>25</b>	<b>26</b>	<b>27</b>	<b>28</b>	<b>29</b>	<b>30</b>	<b>31</b>
<b>Priority</b>	Low ▾	Low ▾	Low ▾	Low ▾	Low ▾	Low ▾	Low ▾	Low ▾
<b>DSCP</b>	<b>32</b>	<b>33</b>	<b>34</b>	<b>35</b>	<b>36</b>	<b>37</b>	<b>38</b>	<b>39</b>
<b>Priority</b>	Middle ▾	Middle ▾	Middle ▾	Middle ▾	Middle ▾	Middle ▾	Middle ▾	Middle ▾
<b>DSCP</b>	<b>40</b>	<b>41</b>	<b>42</b>	<b>43</b>	<b>44</b>	<b>45</b>	<b>46</b>	<b>47</b>
<b>Priority</b>	Middle ▾	Middle ▾	Middle ▾	Middle ▾	Middle ▾	Middle ▾	Middle ▾	Middle ▾
<b>DSCP</b>	<b>48</b>	<b>49</b>	<b>50</b>	<b>51</b>	<b>52</b>	<b>53</b>	<b>54</b>	<b>55</b>
<b>Priority</b>	High ▾	High ▾	High ▾	High ▾	High ▾	High ▾	High ▾	High ▾
<b>DSCP</b>	<b>56</b>	<b>57</b>	<b>58</b>	<b>59</b>	<b>60</b>	<b>61</b>	<b>62</b>	<b>63</b>
<b>Priority</b>	High ▾	High ▾	High ▾	High ▾	High ▾	High ▾	High ▾	High ▾

Apply Help

Label	Description
<b>Priority</b>	Assigns a port to a priority queue. Four priority queues are available: <b>High</b> , <b>Middle</b> , <b>Low</b> , and <b>Lowest</b> .
<b>Apply</b>	Click to apply the configurations
<b>Help</b>	Shows help file.

## 5.5 DHCP Server

The switch provides DHCP server functions. By enabling DHCP, the switch will become a

DHCP server and dynamically assigns IP addresses and related IP information to network clients.

### 5.5.1 Basic Setting

This page allows you to set up DHCP settings for the switch. You can check the **Enabled** checkbox to activate the function. Once the box is checked, you will be able to input information in each column.

**DHCP Server - Basic Setting**

DHCP Server :  ▾

<b>Low IP Address</b>	<input type="text" value="192.168.10.2"/>
<b>High IP Address</b>	<input type="text" value="192.168.10.200"/>
<b>Subnet Mask</b>	<input type="text" value="255.255.255.0"/>
<b>Gateway</b>	<input type="text" value="192.168.10.254"/>
<b>DNS</b>	<input type="text" value="0.0.0.0"/>
<b>Lease Time (sec)</b>	<input type="text" value="604800"/>

Label	Description
<b>DHCP Server</b>	Enables or disables DHCP server function. When enabled, the switch will become the DHCP server on your local network.
<b>Low IP Address</b>	The beginning of the dynamic IP address range. The lowest IP address in the range is considered the start IP address. For example, if the range is from 192.168.1.100 to 192.168.1.200, 192.168.1.100 will be the start IP address.
<b>High IP Address</b>	The end of the dynamic IP address range. The highest IP address in the range is considered the end IP address. For example, if the range is from 192.168.1.100 to 192.168.1.200, 192.168.1.200 will be the end IP address
<b>Subnet Mask</b>	The subnet mask for the dynamic IP assign range
<b>Gateway</b>	The gateway of your network
<b>DNS</b>	The DNS IP of your network
<b>Lease Time (sec)</b>	The length of time that the client may use the IP address it has

	been assigned. The time is measured in seconds.
<b>Apply</b>	Click to apply the configurations

### 5.5.2 Client List

When DHCP server functions are activated, the switch will collect DHCP client information and display it in the following table.

**DHCP Server - Client List**

IP addr	Client ID	Type	Status	Lease
192.168.10.2	00:1E:94:3A:04:B0	dynamic	DHCPOffer	604798

### 5.5.3 Port and IP Bindings

You can assign a specific IP address within the dynamic IP range to a specific port. When a device is connected to the port and requests for dynamic IP assigning, the switch will assign the IP address that has previously been assigned to the connected device.

**DHCP Server - Port and IP Binding**

Port	IP
Port.01	192.168.10.123
Port.02	0.0.0.0
Port.03	0.0.0.0
Port.04	0.0.0.0
Port.05	0.0.0.0

### 5.5.4 Relay Agent

DHCP relay is used to forward and transfer DHCP messages between the clients and the server when they are not in the same subnet domain. You can configure the function in this page.

### DHCP Relay Agent

Mode : Enable

DHCP Server IP Address

<b>1st Server IP</b>	<input type="text" value="0.0.0.0"/>	<b>VID</b>	<input type="text" value="1"/>
<b>2nd Server IP</b>	<input type="text" value="0.0.0.0"/>	<b>VID</b>	<input type="text" value="1"/>
<b>3rd Server IP</b>	<input type="text" value="0.0.0.0"/>	<b>VID</b>	<input type="text" value="1"/>
<b>4th Server IP</b>	<input type="text" value="0.0.0.0"/>	<b>VID</b>	<input type="text" value="1"/>

DHCP Option 82 Remote ID

<b>Type</b>	<span>IP</span> <input type="button" value="v"/>
<b>Value</b>	<input type="text" value="192.168.10.1"/>
<b>Display</b>	<input type="text" value="00A80A01"/>

DHCP Option 82 Circuit-ID Table

Port No.	Circuit-ID	Option 82
Port.01	000400010001	<input type="checkbox"/>
Port.02	000400010002	<input type="checkbox"/>
Port.03	000400010003	<input type="checkbox"/>
Port.04	000400010004	<input type="checkbox"/>
Port.05	000400010005	<input type="checkbox"/>
Port.06	000400010006	<input type="checkbox"/>
Port.07	000400010007	<input type="checkbox"/>
Port.08	000400010008	<input type="checkbox"/>
G1	000400010009	<input type="checkbox"/>
G2	00040001000a	<input type="checkbox"/>

Label	Description
<b>DHCP Relay</b>	Enables or disables DHCP relay agent
<b>DHCP Server IP Address and VID</b>	Specify the IP address and VID of the DHCP server. <b>0.0.0.0</b> means the server is inactive.
<b>DHCP Option 82 Remote ID</b>	Provides an identifier for the remote server. Four types of IDs are supported: <b>IP</b> , <b>MAC</b> , <b>Client-ID</b> , and <b>Other</b> .
<b>DHCP Option 82 Circuit-ID Table</b>	Encodes an agent-local identifier of the circuit from which a DHCP client-to-server packet is received. It is intended for use by agents

	in relaying DHCP responses back to the proper circuit.
<b>Apply</b>	Click to apply the configurations

## 5.6 SNMP

SNMP (Simple Network Management Protocol) is a protocol for managing devices on IP networks. It is mainly used network management systems to monitor the operational status of networked devices. In an event-triggered situation, traps and notifications will be sent to administrators.

### 5.6.1 Agent Setting

An SNMP agent will receive and process requests, send responses to the manager, and send traps when an event occurs. The following page allows you to configure the SNMP agent for the switch.

#### SNMP - Agent Setting

SNMP Agent Version  ▼

#### SNMP V1/V2c Community

Community String	Privilege
<input type="text" value="public"/>	Read Only <span style="float: right;">▼</span>
<input type="text" value="private"/>	Read and Write <span style="float: right;">▼</span>
<input type="text"/>	Read Only <span style="float: right;">▼</span>
<input type="text"/>	Read Only <span style="float: right;">▼</span>

Label	Description
<b>SNMP Agent Version</b>	The column shows the version of the SNMP agent used by the switch. Three SNMP versions are supported, including <b>SNMP V1</b> , <b>SNMP V2c</b> , and <b>SNMP V3</b> . SNMP V1/SNMP V2c agents use a community string to authenticate the SNMP management station and SNMP agent. SNMP V3 requires MD5 or DES authentication which will encrypt data for higher data security.
<b>Community String</b>	The default community string that provides monitoring or read capability is often <b>public</b> . The default management or write community string is often <b>private</b> . Do not leave the community string to public on

	any of your SNMP agents. Since anyone with SNMP manager software installed on his/her PC can make changes to your SNMP agents, this will expose your SNMP agent to any SNMP management station.
<b>Privilege</b>	Choose the appropriate access level from the dropdown list. <b>Read Only:</b> The community string can only read the values of MIB objects. <b>Write Only:</b> The community string can read and write the values of MIB objects. <b>Read and Write:</b> The community string can read and write the values of MIB objects and send MIB object values for a trap and inform messages.
<b>Apply</b>	Click to apply the configurations

### 5.6.2 Trap Setting

SNMP traps are event reports sent to a list of managers configured to receive event notifications when an error occurs. SNMP traps provide the value of one or more instances of management information. A trap manager is a management station that receives traps. If no trap manager is defined, no traps will be issued. You can create a trap manager by entering the IP address of the station and a community string.

#### SNMP - Trap Setting

##### Trap Server Setting

<b>Server IP</b>	<input type="text"/>
<b>Community</b>	<input type="text"/>
<b>Trap Version</b>	<input checked="" type="radio"/> V1 <input type="radio"/> V2c

##### Trap Server Profile

Server IP	Community	Trap Version
(none)		

Label	Description
<b>Server IP</b>	The IP address of the server to receive traps
<b>Community</b>	The community string for authentication
<b>Trap Version</b>	The trap version. V1 and V2c are supported.
<b>Add</b>	Click to add the trap sever to the trap server profile.
<b>Trap Server Profile</b>	Shows a list of trap servers, including their community strings and trap versions.
<b>Remove</b>	Click to remove a trap server from the profile

### 5.6.3 SNMPV3

Unlike SNMP v1 and v2 which uses community strings for authentication, SNMP v3 uses username/password authentication, along with an encryption key. Therefore, SNMPv3 provides greater security features for authentication, privacy, and access control. The switch supports SNMP v3 which can be configured in the following page.

#### NMP - SNMPv3 Setting

SNMPv3 Engine ID: f465000003001e940a002b

##### Context Table

Context Name :

##### User Table

Current User Profiles : <input type="button" value="Remove"/>	New User Profile : <input type="button" value="Add"/>	
(none)	User ID:	<input type="text"/>
	Authentication Password:	<input type="text"/>
	Privacy Password:	<input type="text"/>

##### Group Table

Current Group content : <input type="button" value="Remove"/>	New Group Table: <input type="button" value="Add"/>	
(none)	Security Name (User ID):	<input type="text"/>
	Group Name:	<input type="text"/>

Current Access Tables :		New Access Table :	
Remove		Add	
(none)	Context Prefix:	<input type="text"/>	
	Group Name:	<input type="text"/>	
	Security Level:	<input type="radio"/> NoAuthNoPriv. <input type="radio"/> AuthNoPriv. <input type="radio"/> AuthPriv.	
	Context Match Rule	<input type="radio"/> Exact <input type="radio"/> Prefix	
	Read View Name:	<input type="text"/>	
	Write View Name:	<input type="text"/>	
	Notify View Name:	<input type="text"/>	

**MIBView Table**

Current MIBTables :		New MIBView Table :	
Remove		Add	
(none)	View Name:	<input type="text"/>	
	SubOid-Tree:	<input type="text"/>	
	Type:	<input type="radio"/> Excluded <input type="radio"/> Included	

**Note:**  
 Any modification of SNMPv3 tables might cause MIB accessing rejection. Please take notice of the causality between the tables before you modify these tables.

Label	Description
<b>Context Table</b>	Context is a collection of management information accessible by a SNMP entity and is stored in the context table. You can assign a context name to the context table and click <b>Apply</b> to change the name.
<b>User Table</b>	<p>You can manage existing and add new user profiles in this section. In Current User Profiles, select an entry you want to remove and click Remove. In New User Profiles, specify the following information of a new entry:</p> <p><b>User ID:</b> the username of the user</p> <p><b>Authentication Password:</b> the authentication password for the user</p> <p><b>Privacy Password:</b> the private password for the user</p> <p>Click <b>Add</b> after inputting the information.</p>
<b>Group Table</b>	<p>You can manage existing and add new group content in this section. In Current Group Content, select an entry you want to remove and click <b>Remove</b>. In New Group Table, specify the following information for a new entry:</p> <p><b>Security Name (User ID):</b> the name of the user to be added to the</p>



	<p>table.</p> <p><b>Group Name:</b> the name of the group</p> <p>Click <b>Add</b> after inputting the information.</p>
<b>Access Table</b>	<p>The Access table lists the access rights and restrictions of the various groups. 1. You can manage existing and add new tables in this section. In Current Access Tables, select an entry you want to remove and click <b>Remove</b>. In New Access Table, specify the following information for a new entry:</p> <p><b>Context Prefix:</b> the context name of the user as defined in the context table.</p> <p><b>Group Name:</b> set up the group.</p> <p><b>Security Level:</b> the security level of the user</p> <p><b>Context Match Rule:</b> the rule for matching context</p> <p><b>Read View Name:</b> the read view name provided for the v3 user</p> <p><b>Write View Name:</b> the write view name provided for the v3 user.</p> <p><b>Notify View Name:</b> the notify view name provided for the v3 user.</p> <p>Click <b>Add</b> after inputting the information.</p>
<b>MIBview Table</b>	<p>You can configure MIB views for users and groups by entering the OID number of the MIB view. A MIB view consists of a family of view subtrees which may be individually included in or (occasionally) excluded from the view. Each view subtree is defined by a combination of an OID subtree together with a bit string mask. The view table is indexed by the view name and subtree OID values.</p> <p>In New MIBview Table, enter the following information:</p> <p><b>ViewName:</b> the name of the view</p> <p><b>Sub-Oid Tree:</b> fill in the Sub OID.</p> <p><b>Type:</b> select the type as <b>excluded</b> or <b>included</b>.</p> <p>Click <b>Add</b> after inputting the information.</p>

## 5.7 Security

The switch supports five security functions: IP security, port security, MAC blacklist, MAC address aging, and 802.1x protocol.

### 5.7.1 IP Security

By setting up a secure IP list, only IP addresses in the list can manage the switch according to the management mode you have specified (WEB, Telnet, SNMP, etc.).

Mode :

Enable WEB Management  
 Enable Telnet Management  
 Enable SNMP Management

Secure IP List

Secure IP1	<input type="text" value="0.0.0"/>
Secure IP2	<input type="text" value="0.0.0"/>

Label	Description
<b>Mode</b>	Indicates IP security mode. Enables or disables IP security functions.
<b>Enable WEB Management</b>	Check to enable WEB management
<b>Enable Telnet Management</b>	Check to enable Telnet management
<b>Enable SNMP Management</b>	Check to enable MPSN management
<b>Apply</b>	Click to apply the configurations.
<b>Help</b>	Shows help file.

### Port Security

You can use static MAC addresses to provide port security for the switch. With this method, only the frames with the MAC addresses in this list will be forwarded, otherwise will be discarded.

MAC Address :

Port No :

	MAC Address	Port No.
<input type="checkbox"/>	001122334455	Port.06

Label	Description
<b>MAC Address</b>	Enter a MAC address for a specific port.
<b>Port NO.</b>	Select a switch port
<b>Add</b>	Add the MAC address and port information.
<b>Delete</b>	Deletes an entry
<b>Help</b>	Shows help file

### MAC Blacklist

You can block specific devices from network access by creating a MAC blacklist. MAC blacklists will prevent traffic from forwarding to specific MAC addresses in the list. Any frames forwarding to the MAC addresses in this list will be discarded. As a result, the target device will never receive any frame.

The screenshot shows a web interface for configuring a MAC blacklist. At the top, there is a label 'MAC Address :' followed by an empty text input field. Below this are two buttons: 'Add' and 'Help'. In the center, there is a table with a header 'MAC Address' and one row containing a checkbox and the MAC address '001E94123456'. Below the table are two buttons: 'Delete' and 'Help'.

Label	Description
<b>MAC Address</b>	Enter a MAC address for a specific port.
<b>Port NO.</b>	Select a switch port
<b>Add</b>	Add the MAC address and port information.
<b>Delete</b>	Delete an entry
<b>Help</b>	Shows help file

### 802.1x

The IEEE 802.1X standard defines a port-based access control procedure that prevents unauthorized access to a network by requiring users to first submit credentials for authentication. One or more backend servers (RADIUS) determine whether the user is allowed access to the network.

In an 802.1X network environment, the user is called the supplicant, the switch is the authenticator, and the RADIUS server is the authentication server. The switch acts as the

man-in-the-middle, forwarding requests and responses between the supplicant and the authentication server. Frames sent between the supplicant and the switch are special 802.1X frames, known as EAPOL (EAP Over LANs) frames which encapsulate EAP PDUs. Frames sent between the switch and the RADIUS server are RADIUS packets. RADIUS packets also encapsulate EAP PDUs together with other attributes like the switch's IP address, name, and the supplicant's port number on the switch. EAP is very flexible as it allows for different authentication methods, like MD5-Challenge, PEAP, and TLS. The important thing is that the authenticator (the switch) does not need to know which authentication method the supplicant and the authentication server are using, or how many information exchange frames are needed for a particular method. The switch simply encapsulates the EAP part of the frame into the relevant type (EAPOL or RADIUS) and forwards it.

When authentication is complete, the RADIUS server sends a special packet containing a success or failure indication. Besides forwarding the result to the supplicant, the switch uses it to open up or block traffic on the switch port connected to the supplicant.

Note: in an environment where two backend servers are enabled, the server timeout is configured to X seconds (using the authentication configuration page), and the first server in the list is currently down (but not considered dead), if the supplicant retransmits EAPOL Start frames at a rate faster than X seconds, it will never be authenticated because the switch will cancel on-going backend authentication server requests whenever it receives a new EAPOL Start frame from the supplicant. Since the server has not failed (because the X seconds have not expired), the same server will be contacted when the next backend authentication server request from the switch. This scenario will loop forever. Therefore, the server timeout should be smaller than the supplicant's EAPOL Start frame retransmission rate.

### 802.1x - Radius Server

Radius Server Setting

<b>802.1x Protocol</b>	Enable <input type="button" value="v"/>
<b>Radius Server IP</b>	192.168.16.3
<b>Server Port</b>	1812
<b>Accounting Port</b>	1813
<b>Shared Key</b>	12345678
<b>NAS, Identifier</b>	NAS_L2_SWITCH

Advanced Setting

<b>Quiet Period</b>	60
<b>TX Period</b>	30
<b>Supplicant Timeout</b>	30
<b>Server Timeout</b>	30
<b>Max Requests</b>	2
<b>Re-Auth Period</b>	3600

Label	Description
<b>802.1x Protocol</b>	Enables or disables 802.1X Radius server
<b>Radius Server IP</b>	IP address of the authentication server
<b>Server Port</b>	The UDP port number used by the authentication server to authenticate
<b>Accounting Port</b>	The number of the UDP port that the RADIUS server uses for accounting requests.
<b>Shared Key</b>	A key shared between the switch and authentication server
<b>NAS, Identifier</b>	A string used to identify the switch.
<b>Quiet Period</b>	The time interval between authentication failure and the start of a new authentication attempt.
<b>Tx Period</b>	The time that the switch waits for response to an EAP request/identity frame from the client before resending the request.
<b>Supplicant Timeout</b>	The period of time the switch waits for a supplicant respond to an EAP request.
<b>Server Timeout</b>	The period of time the switch waits for a Radius server respond to an authentication request.

<b>Max Requests</b>	The maximum number of times to retry sending packets to the supplicant.
<b>Re-Auth Period</b>	The period of time after which clients connected must be re-authenticated
<b>Apply</b>	Click to apply the configurations
<b>Help</b>	Shows help file

The 802.1x authorized mode of each port can be set in the following dialog:

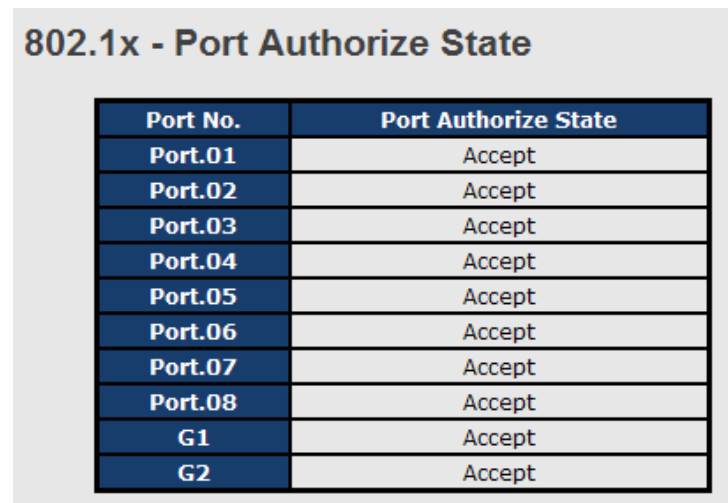

Label	Description
<b>Port Authorize Mode</b>	<p><b>Reject:</b> force the port to be unauthorized</p> <p><b>Accept:</b> force the port to be authorized</p> <p><b>Authorize:</b> the state of the port is determined by the outcome of the 802.1x authentication</p> <p><b>Disable:</b> the port will not participate in the 802.1x portocol</p>
<b>Apply</b>	Click to apply the configurations
<b>Help</b>	Shows help file

## 5.7.2 IP Guard

### Port Setting

This page allows you to configure IP guard functions for each port, an intelligent and user-friendly IP security method. It protects the network from unknown IP (IPs not in the allowed list) attack. Unauthorized IP traffic will be blocked.

Port No.	Mode
Port.01	Monitor <input type="button" value="v"/>
Port.02	Security <input type="button" value="v"/>
Port.03	Disabled <input type="button" value="v"/>
Port.04	Disabled <input type="button" value="v"/>

Label	Description
<b>Mode</b>	<p><b>Disabled:</b> disables the function</p> <p><b>Monitor:</b> scans the IP information of the connected device before implementing further actions</p> <p><b>Security:</b> performs security actions without scanning the information of the connected device</p>
<b>Apply</b>	Click to apply the configurations
<b>Help</b>	Shows help file

### Allow List

By creating an allow list, traffic from the IP addresses in the list will be allowed.

**IP Guard - Allow List**

Delete	IP	MAC	Port	Status
<input type="checkbox"/>	192.168.10.66	001E94112547	G1	Active <input type="button" value="v"/>

IP	MAC	Port	Status
<input type="text"/>	<input type="text"/>	Port.01 <input type="button" value="v"/>	Active <input type="button" value="v"/>

Label	Description
<b>IP</b>	IP address of the allowed entry
<b>MAC</b>	MAC address of the allowed entry

<b>Port</b>	Port number of the allowed entry
<b>Status</b>	The option allows you to block suspicious IP traffic. <b>Active:</b> allows the IP traffic. <b>Suspend:</b> blocks the IP traffic.
<b>Delete</b>	Check to delete an entry

### Super-IP List

A super-IP list enables you to give full access to the switch to the user you specify. Devices with the IP addresses listed in the table will be able to manage the switch disregarding the rule you have set.

**IP Guard - Super-IP List**

IP Address :

Super-IP List

IP Address

### Monitor List

You can create a monitor list to monitor IP traffic of individual ports automatically.

**IP Guard - Monitor List**

Add to Allow List	IP	MAC	Port	Time
<input type="checkbox"/>	192.168.10.66	001E94988989	Port.08	19700103 19:20

<b>Label</b>	Description
<b>IP</b>	IP address of the port
<b>MAC</b>	MAC address of the port



<b>Port</b>	The port number you want to monitor
<b>Time</b>	The time when the entry is logged.
<b>Add to Allow List</b>	Check to add the entry to the allow list

## 5.8 Warning

The switch supports several alerting methods, including SYSLOG, e-mail, and fault relay. These methods enable you to monitor switch status remotely. When an event occurs, the system will send an alert to your appointed servers.

### 5.8.1 SYSLOG Setting

SYSLOG is a protocol that allows a device to send event notification messages across IP networks to event message collectors. It permits separation of the software that generates messages from the system that stores them and the software that reports and analyzes them. As Syslog messages are UDP-based, the sender and receiver will not be aware of it if the packet is lost due to network disconnection and no UDP packet will be resent.

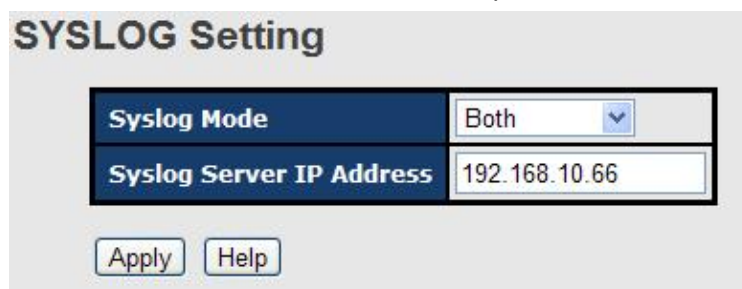

Label	Description
<b>Syslog Mode</b>	<b>Disable:</b> disables SYSLOG <b>Client Only:</b> logs in to a local system <b>Server Only:</b> logs in to a remote SYSLOG server <b>Both:</b> logs in to a local and remote server.
<b>SYSLOG Server IP Address</b>	The IP address of the remote SYSLOG server
<b>Apply</b>	Click to apply the configurations
<b>Help</b>	Shows help file

### 5.8.2 SMTP Setting

SMTP (Simple Mail Transfer Protocol) is a protocol for transmitting e-mails across the Internet. By setting up SMTP alert, the device will send a notification e-mail when a user-defined event occurs.

### SMTP Setting

E-mail Alert:

<b>SMTP Server IP Address :</b>	<input type="text" value="192.168.10.66"/>
<b>Mail Subject :</b>	<input type="text" value="Automated Email Alert"/>
<b>Sender :</b>	<input type="text" value="test mail"/>
<b>■ Authentication</b>	
<b>Rcpt e-mail Address 1 :</b>	<input type="text" value="test@192.168.10.66"/>
<b>Rcpt e-mail Address 2 :</b>	<input type="text"/>
<b>Rcpt e-mail Address 3 :</b>	<input type="text"/>
<b>Rcpt e-mail Address 4 :</b>	<input type="text"/>

Label	Description
<b>E-mail Alert</b>	Enables or disables transmission of system warnings by e-mail
<b>SMTP Server IP Address</b>	The IP address of the SMTP server to receive the notification e-mail
<b>Mail Subject</b>	Subject of the mail
<b>Sender</b>	The email account to send the alert
<b>Authentication</b>	<ul style="list-style-type: none"> <li>■ <b>Username:</b> the authentication username</li> <li>■ <b>Password:</b> the authentication password</li> <li>■ <b>Confirm Password:</b> re-enter password</li> </ul>
<b>Recipient E-mail Address</b>	The recipient's e-mail address. A mail allows for 6 recipients.
<b>Apply</b>	Click to activate the configurations
<b>Help</b>	Shows help file

### 5.8.3 Event Selection

The device supports both SYSLOG and SMTP alerts. Check the corresponding box to enable the system event warning method you want. Please note that the checkboxes will gray out if SYSLOG or SMTP is disabled.

**Event Selection**

System Event

Event Type	Syslog	SMTP
Device cold start	<input checked="" type="checkbox"/>	<input type="checkbox"/>
Device warm start	<input checked="" type="checkbox"/>	<input type="checkbox"/>
Authentication failure	<input type="checkbox"/>	<input checked="" type="checkbox"/>
O-Ring topology change	<input type="checkbox"/>	<input checked="" type="checkbox"/>

Port Event

Port	Syslog	SMTP
Port.01	Link Down	Disable
Port.02	Disable	Link Up & Link Down

Label	Description
<b>Device cold start</b>	Sends alerts when you restart the device using the power button on your PC.
<b>Device warm start</b>	Sends alerts when you restart the device using the Reset button or software.
<b>Authentication Failure</b>	Sends alerts when SNMP authentication fails
<b>O-Ring topology change</b>	Sends alerts when O-Ring topology changes
<b>Port Event</b>	<p>Sends alerts when the port meets a specified condition. Available options include:</p> <ul style="list-style-type: none"> <li>■ <b>Disable:</b> disables alert function</li> <li>■ <b>Link Up:</b> sends alerts when port is connected</li> <li>■ <b>Link Down:</b> sends alerts when port is not connected</li> <li>■ <b>Link Up &amp; Link Down:</b> sends alerts when port is connected and disconnected</li> </ul>
<b>Apply</b>	Click to apply the configurations
<b>Help</b>	Shows help file

## 5.9 Monitor and Diag

### 5.9.1 System Event Log

If a system log client is enabled, the system event log will be shown in this table.

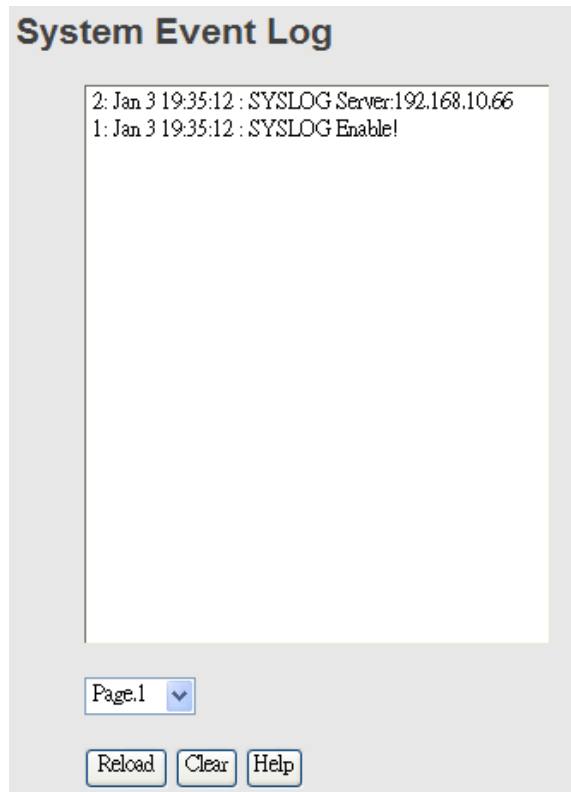

Label	Description
<b>Page</b>	The page number of the selected LOG
<b>Reload</b>	Click to refresh the information in this page
<b>Clear</b>	Clear log
<b>Help</b>	Shows help file

### 5.9.2 MAC Address Table

A MAC address table is a table in a network switch that maps MAC addresses to ports. The switch uses the table to determine which port the incoming packet should be forwarded to. Entries in a MAC address table fall into two types: dynamic and static entries. Entries in a static MAC table are added or removed manually and cannot age out by themselves. Entries in a dynamic MAC table will age out after a configured aging time. Such entries can be added by learning or manual configuration.

#### Aging Configuration

Aging enables the switch to track only active MAC addresses on the network and flush out MAC addresses that are no longer used, thereby keeping the table current. You can configure aging time by entering a value in the **MAC Address Aging Time** box. Note that aging time

must be a multiple of 15.

### MAC Table Learning

The switch can add the address and port on which the packet was received to the MAC table if the address does not exist in the table by examining the source address of each packet received on a port. This is called learning. It allows the MAC table to expand dynamically. If the learning mode for a given port is grayed out, it means another module is in control of the mode, and thus the user cannot change the configurations. An example of such a module is MAC-Based authentication under 802.1X.

### MAC Address Table

Port No. :

Type	MAC Address	Port No.
Static	001122334455	Port.06
Dynamic	001E94988989	Port.08
Static	01005E000006	Port.05

Dynamic Address Count : 1  
Static Address Count : 2

#### MAC Address Aging Setting

MAC Address Aging Time:

Auto Flush Table When Ports Link Down:

MAC Address Auto Learning:

Label	Description
<b>Port NO. :</b>	Shows all MAC addresses mapped to a selected port in the table
<b>Flush Table</b>	Clears all MAC addresses in the table
<b>Help</b>	Shows help file.
<b>MAC Address Aging Time</b>	The time of an entry stays valid in the table
<b>Auto Flush Table When Ports Link Down</b>	Clears the MAC table automatically when ports are disconnected
<b>MAC Address Auto Learning</b>	Enables or disables MAC learning function

<b>Apply</b>	Click to apply the configurations.
--------------	------------------------------------

### Port Overview

This page provides an overview of general traffic statistics for all switch ports.

Port Overview									
Port No.	Type	Link	State	TX Good Packet	TX Bad Packet	RX Good Packet	RX Bad Packet	TX Abort Packet	Packet Collision
Port.01	100TX	Down	Forwarding	0	0	0	0	0	0
Port.02	100TX	Down	Forwarding	0	0	0	0	0	0
Port.03	100TX	Down	Forwarding	0	0	0	0	0	0
Port.04	100TX	Down	Forwarding	0	0	0	0	0	0

Label	Description
<b>Type</b>	Shows port speed and media type.
<b>Link</b>	Shows port link status
<b>State</b>	Shows port status
<b>TX GOOD Packet</b>	The number of good packets sent by this port
<b>TX Bad Packet</b>	The number of bad packets sent by this port
<b>RX GOOD Packet</b>	The number of good packets received by this port
<b>RX Bad Packet</b>	The number of bad packets received by this port
<b>TX Abort Packet</b>	The number of packets aborted by this port
<b>Packet Collision</b>	The number of times a collision is detected by this port
<b>Clear</b>	Clears all counters
<b>Help</b>	Shows help file

### Port Counter

The displayed counters include the total number for receive and transmit, the size for receive and transmit, and the errors for receive and transmit.

### 5.9.3 Port Counters

This page shows statistic counters for the port. The **Clear** button will reset all counters to zero.

Port No. :

<b>InGoodOctetsLo</b>	<b>InGoodOctetsHi</b>	<b>InBadOctets</b>	<b>OutFCSErr</b>
0	0	0	0
<b>InUnicasts</b>	<b>Deferred</b>	<b>InBroadcasts</b>	<b>InMulticasts</b>
0	0	0	0
<b>Octets64</b>	<b>Octets127</b>	<b>Octets255</b>	<b>Octets511</b>
0	0	0	0
<b>Octets1023</b>	<b>OctetsMax</b>	<b>OutOctetsLo</b>	<b>OutOctetsHi</b>
0	0	0	0
<b>OutUnicasts</b>	<b>Excessive</b>	<b>OutMulticasts</b>	<b>OutBroadcasts</b>
0	0	0	0
<b>Single</b>	<b>OutPause</b>	<b>InPause</b>	<b>Multiple</b>
0	0	0	0
<b>Undersize</b>	<b>Fragments</b>	<b>Oversize</b>	<b>Jabber</b>
0	0	0	0
<b>InMACRcvErr</b>	<b>InFCSErr</b>	<b>Collisions</b>	<b>Late</b>
0	0	0	0

Label	Description
<b>InGoodOctetsLo</b>	The lower 32-bits of the 64-bit InGoodOctets counter. This field indicates the total length of all good Ethernet frames received.
<b>InGoodOctetsHi</b>	The upper 32-bits of the 64-bit InGoodOctets counter. This field indicates the total length of all good Ethernet frames received.
<b>InBadOctets</b>	The total length of all bad Ethernet frames received.
<b>OutFCSErr</b>	The number of frames transmitted with an invalid FCS. Whenever a frame is modified during transmission (e.g., to add or remove a tag), the frame's original FCS is inspected before a new FCS is added to a modified frame. If the original FCS is invalid, the new FCS is made invalid too and this counter is incremented.
<b>InUnicasts</b>	The number of good frames received that have a Unicast destination MAC address.
<b>Deferred</b>	The total number of successfully transmitted frames without collision but are delayed because the medium is busy during the first attempt. This counter is applicable in half-duplex only.
<b>InBroadcasts</b>	The number of good frames received that have a Broadcast destination MAC address.
<b>InMulticasts</b>	The number of good frames received that have a Multicast destination MAC address.
<b>Octets64</b>	Total frames received (and/or transmitted) with a length of exactly 64 octes, including those with errors.

<b>Octets127</b>	Total frames received (and/or transmitted) with a length of between 65 and 127 octes, including those with errors.
<b>Octets255</b>	Total frames received (and/or transmitted) with a length of between 128 and 255 octes, including those with errors.
<b>Octets511</b>	Total frames received (and/or transmitted) with a length of between 256 and 511 octes, including those with errors.
<b>Octets1023</b>	Total frames received (and/or transmitted) with a length of between 512 and 1023 octes, including those with errors.
<b>OctetsMax</b>	Total frames received (and/or transmitted) with a length of between 1024 and MaxSize octes, including those with errors.
<b>OutOctetsLo</b>	The lower 32-bit of the 64-bit OutOctets counter. This field indicates the total length of all Ethernet frames sent from this MAC address.
<b>OutOctetsHi</b>	The upper 32-bit of the 64-bit OutOctets counter. This field indicates the total length of all Ethernet frames sent from this MAC address.
<b>OutUnicasts</b>	The number of frames sent with an Unicast destination MAC address.
<b>Excessive</b>	The number frames dropped in the transmitted MAC address because the frame experiences 16 consecutive collisions. This counter is applicable in half-duplex only and only when DiscardExcessive is one.
<b>OutBroadcasts</b>	The number of good frames sent with a Broadcast destination MAC address
<b>Single</b>	The total number of successfully transmitted frames that experiences exactly one collision. This counter is applicable in half-duplex only.
<b>OutPause</b>	The number of good Flow Control frames sent
<b>InPause</b>	The number of good Flow Control frames received
<b>Multiple</b>	The total number of successfully transmitted frames that experience more than one collision. This counter is applicable in half-duplex only.
<b>Undersize</b>	Total frames received with a length of less than 64 octets but with a valid FCS
<b>Fragments</b>	Total frames received with a length of more than 64 octets and with an invalid FCS



<b>Oversize</b>	Total frames received with a length of more than MaxSize octets but with a valid FCS
<b>Jabber</b>	Total frames received with a length of more than MaxSize octets but with an invalid FCS
<b>InMACRcvErr</b>	Total frames received with an RxErr signal from the PHY
<b>InFCSErr</b>	Total frames received with a CRC error not counted in Fragments, Jabber or RxErr.
<b>Collisions</b>	The number of frames for which one or more collisions occurred when the frames were sent, including single, multiple, excessive, or late collisions. This counter is applicable in half-duplex only.
<b>Late</b>	When a collision is detected by a station after it has sent the 512th bit of its frame, it is counted as a late collision. This counter is applicable in half-duplex only.

### Port Monitoring

The switch supports several types of port monitoring including TX (egress) only, RX (ingress) only, and both TX/RX monitoring. TX monitoring sends any data that egress out checked TX source ports to a selected TX destination port as well. RX monitoring sends any data that ingress in checked RX source ports out to a selected RX destination port as well as sending the frame where it normally would have gone. Note that keep all source ports unchecked in order to disable port monitoring.

**Port Monitoring**

Port No.	Destination Port		Source Port	
	RX	TX	RX	TX
Port.01	<input checked="" type="radio"/>	<input checked="" type="radio"/>	<input type="checkbox"/>	<input type="checkbox"/>
Port.02	<input type="radio"/>	<input type="radio"/>	<input type="checkbox"/>	<input type="checkbox"/>
Port.03	<input type="radio"/>	<input type="radio"/>	<input type="checkbox"/>	<input type="checkbox"/>
Port.04	<input type="radio"/>	<input type="radio"/>	<input type="checkbox"/>	<input type="checkbox"/>

Label	Description
<b>Destination Port</b>	The port will receive a copied frame from source port for monitoring purpose.
<b>Source Port</b>	Check to monitor specific ports
<b>TX</b>	The frames transmitted by a port
<b>RX</b>	The frames received by a port

<b>Apply</b>	Click to activate the configurations.
<b>Clear</b>	Clears all checked boxes (disable the function)
<b>Help</b>	Shows help file

### Traffic Monitoring

By enabling traffic monitoring function, the switch will send out an SYSLOG event notification or SMTP e-mail when the traffic becomes too large.

#### Traffic Monitor

Port No.	Monitored-Counter	Time-Interval (1~300s)	Increasing-Quantity
Port.01	RX Octet <input type="button" value="v"/>	<input style="width: 30px;" type="text" value="3"/>	<input style="width: 60px;" type="text" value="1000"/>
Port.02	RX Broadcast <input type="button" value="v"/>	<input style="width: 30px;" type="text" value="3"/>	<input style="width: 60px;" type="text" value="1000"/>
Port.03	RX Multicast <input type="button" value="v"/>	<input style="width: 30px;" type="text" value="3"/>	<input style="width: 60px;" type="text" value="1000"/>
Port.04	RX Unicast <input type="button" value="v"/>	<input style="width: 30px;" type="text" value="3"/>	<input style="width: 60px;" type="text" value="1000"/>
Port.05	RX Non-Unicast <input type="button" value="v"/>	<input style="width: 30px;" type="text" value="3"/>	<input style="width: 60px;" type="text" value="1000"/>
Port.06	Disable <input type="button" value="v"/>	<input style="width: 30px;" type="text" value="3"/>	<input style="width: 60px;" type="text" value="1000"/>

Label	Description
<b>Monitored-Counter</b>	Monitor the incoming traffic by bandwidth or number of packets. Available options include: RX Octet: calculates the total bandwidth consumed by incoming traffic RX Broadcast: calculates the number of broadcast packets RX Multicast: calculates the number of multicast packets RX Unicast: calculates the number of unicast packets RX Non-Unicast: calculates the total number of multicast and broadcast packets Disable: disables the function
<b>Time-Interval</b>	Sets the time interval of counting
<b>Increasing Quantity</b>	- Specify a threahold for the counter. When the result of calucation exceeds the value, an alert will be issued.
<b>Event Alarm</b>	Specifies alarm type (SYSLOG or SMTP)

### 5.9.4 Ping

This command sends ICMP echo request packets to another node on the network. Using the

ping command, you can see if another site on the network can be reached.



After you press **Active**, four ICMP packets will be transmitted, and the sequence number and roundtrip time will be displayed upon reception of a reply. The page refreshes automatically until responses to all packets are received, or until a timeout occurs.

Label	Description
<b>IP Address</b>	Enter the IP address that you want to detect
<b>Active</b>	Click to send ICMP packets

## 5.10 Save Configuration

Click **Save Configuration** whenever you change a configuration to save current configurations; otherwise, the changes you make will be lost when the power is off or system is reset.

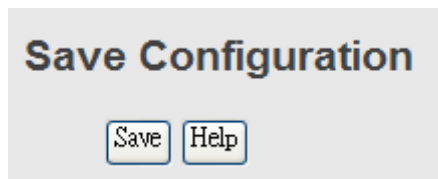

Label	Description
<b>Save</b>	Saves all configurations
<b>Help</b>	Shows help file

## 5.11 Factory Default

This function is to force the switch back to the original factory settings. You can decide to keep current IP address settings or username/password by checking in the boxes.

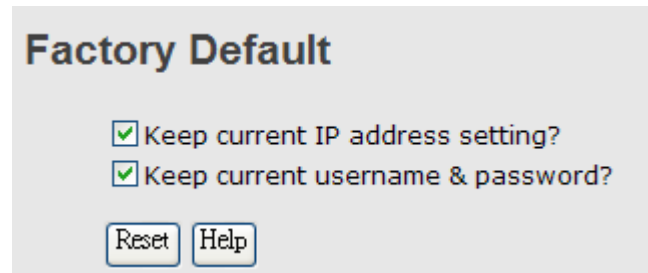

The screenshot shows a web interface titled "Factory Default". It contains two checked checkboxes: "Keep current IP address setting?" and "Keep current username & password?". Below these are two buttons: "Reset" and "Help".

## 5.12 System Reboot

You can reset the stack switch on this page. After reset, the system will boot normally as if you have powered on the devices.

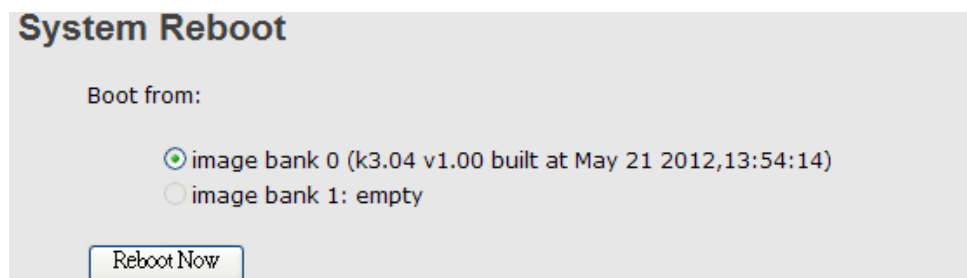

The screenshot shows a web interface titled "System Reboot". It has a section labeled "Boot from:" with two radio button options: "image bank 0 (k3.04 v1.00 built at May 21 2012,13:54:14)" which is selected, and "image bank 1: empty". Below the options is a "Reboot Now" button.

# Command Line Interface Management

Besides Web-based management, the switch also supports CLI management. You can use console or telnet to manage the switch by CLI.

## CLI Management by RS-232 Serial Console (115200, 8, none, 1, none)

Before configuring RS-232 serial console, connect the RS-232 port of the switch to your PC Com port using a RJ45 to DB9-F cable.

Follow the steps below to access the console via RS-232 serial cable.

**Step 1:** On Windows desktop, click on **Start -> Programs -> Accessories -> Communications -> Hyper Terminal**

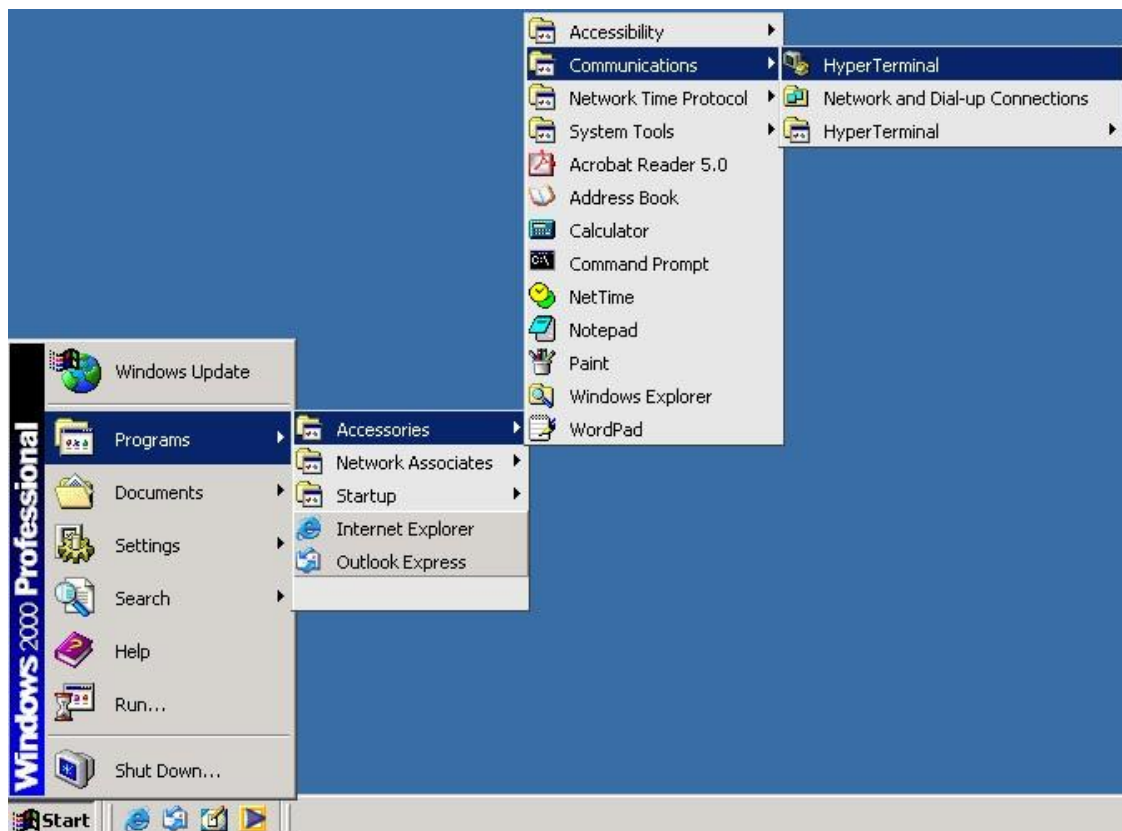

**Step 2.** Input a name for the new connection.

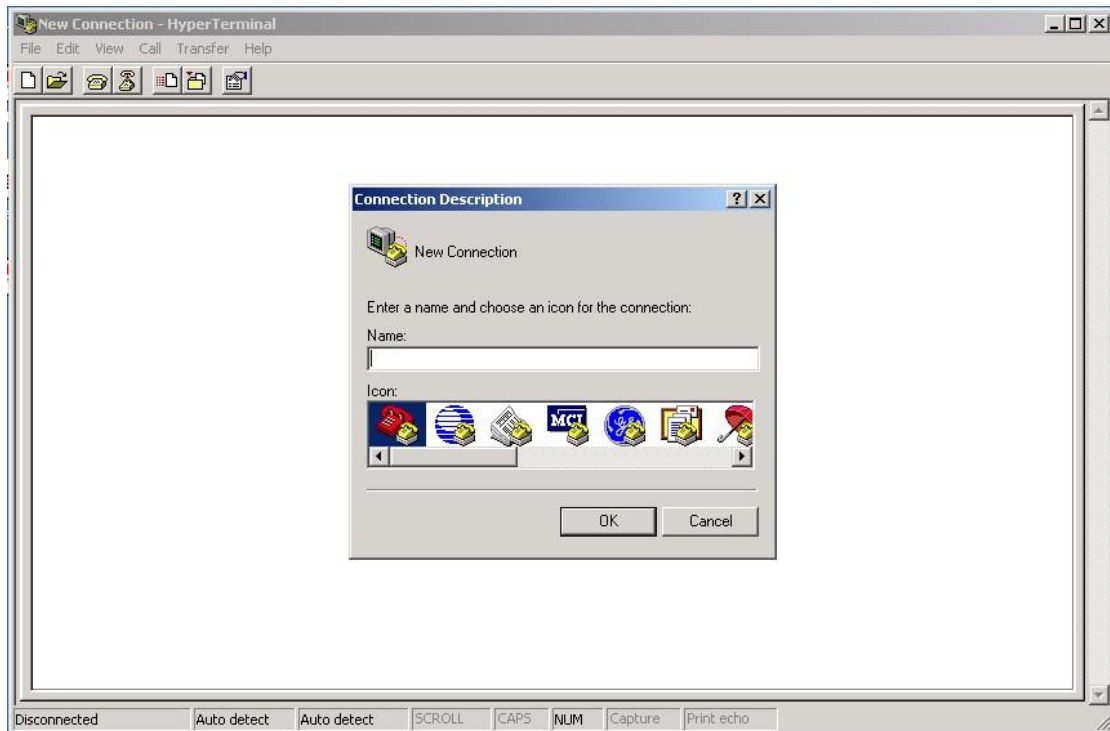

Step 3. Select a COM port in the drop-down list.

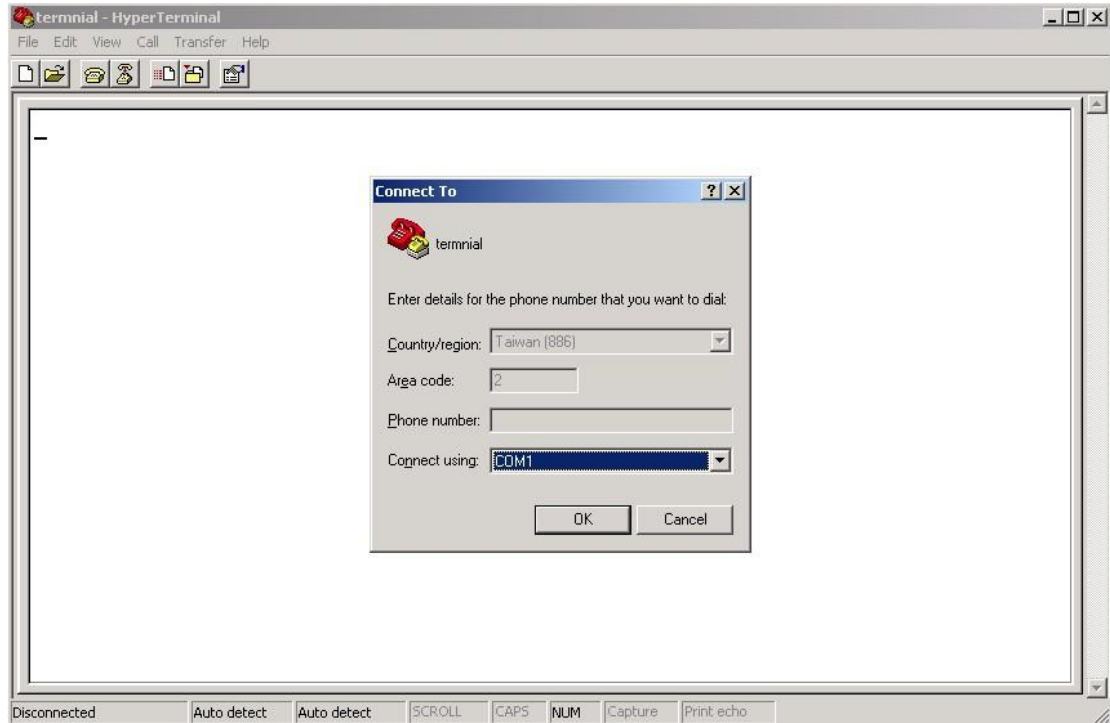

Step 4. A pop-up window that indicates COM port properties appears, including bits per second, data bits, parity, stop bits, and flow control.

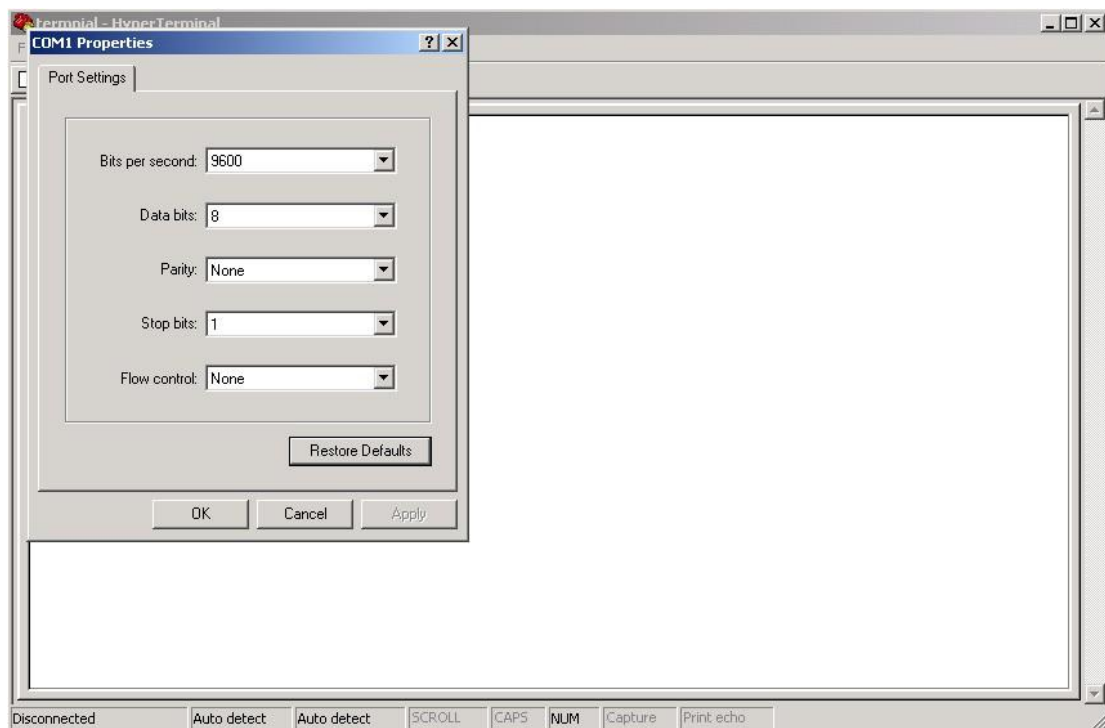

Step 5. The console login screen will appear. Use the keyboard to enter the Username and Password (same as the password for Web browsers), then press **Enter**.

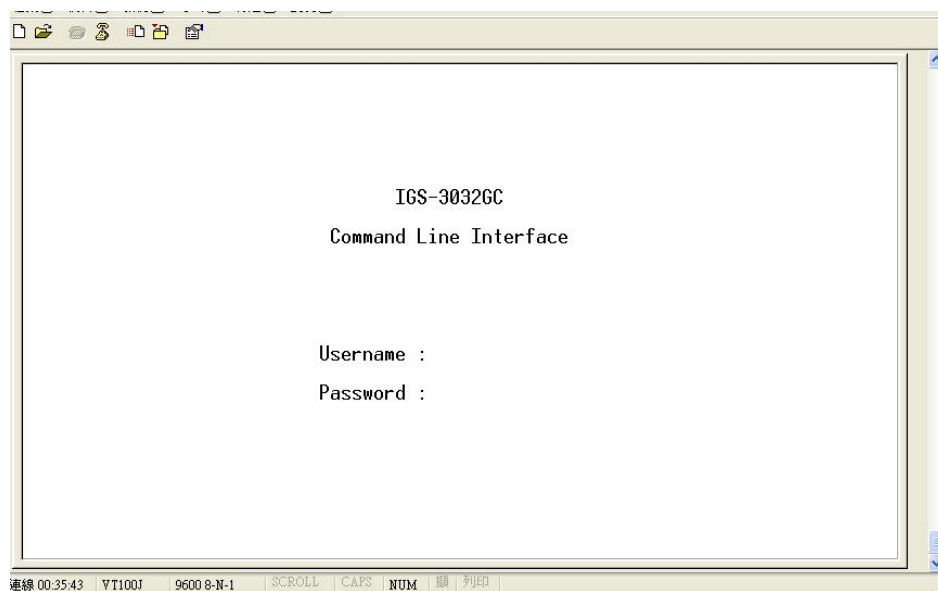

### CLI Management by Telnet

You can use **TELNET** to configure the switch. The default values are:

IP Address: **192.168.10.1**

Subnet Mask: **255.255.255.0**

Default Gateway: **192.168.10.254**

User Name: **admin**

Password: **admin**

Follow the steps below to access console via Telnet.

Step 1. Telnet to the IP address of the switch from the **Run** window by inputting commands (or from the MS-DOS prompt) as below.

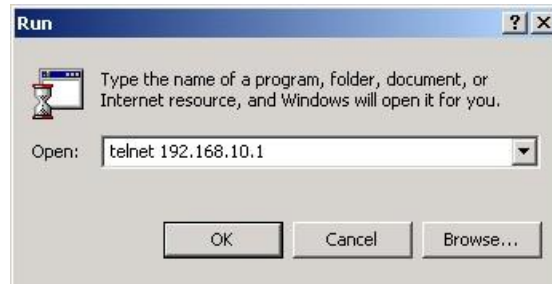

Step 2. The Login screen will appear. Use the keyboard to enter the Username and Password (same as the password for Web browser), and then press **Enter**.

IGS-3032GC  
Command Line Interface

Username :

Password :



**Commands Level**

Modes	Access Method	Prompt	Exit Method	About This Model
User EXEC	Begin a session with your switch.	switch>	Enter <b>logout</b> or <b>quit</b> .	The user command available at the level of user is the subset of those available at the privileged level. Use this mode to <ul style="list-style-type: none"> <li>• Enter menu mode.</li> <li>• Display system information.</li> </ul>
Privileged EXEC	Enter the <b>enable</b> command while in user EXEC mode.	switch#	Enter <b>disable</b> to exit.	The privileged command is advance mode Privileged this mode to <ul style="list-style-type: none"> <li>• Display advance function status</li> <li>• save configures</li> </ul>
Global configuration	Enter the <b>configure</b> command while in privileged EXEC mode.	switch(configuration)#	To exit to privileged EXEC mode, enter <b>exit</b> or <b>end</b>	Use this mode to configure parameters that apply to your Switch as a whole.
VLAN database	Enter the <b>vlan database</b> command while in privileged EXEC mode.	switch(vlan)#	To exit to user EXEC mode, enter <b>exit</b> .	Use this mode to configure VLAN-specific parameters.
Interface configuration	Enter the <b>interface</b> command (with a specific interface) while in global configuration mode	switch(configuration-if)#	To exit to global configuration mode, enter <b>exit</b> . To exist privileged EXEC mode	Use this mode to configure parameters for the switch and Ethernet ports.

			or end.	
--	--	--	---------	--

**Symbol of Command Level.**

Mode	Symbol of Command Level
User EXEC	E
Privileged EXEC	P
Global configuration	G
VLAN database	V
Interface configuration	I

**6.1 Commands Set List—System Commands Set**

IGS-3032GCCommands	Level	Description	Example
<b>show config</b>	<b>E</b>	Show switch configuration	switch>show config
<b>show terminal</b>	<b>P</b>	Show console information	switch#show terminal
<b>write memory</b>	<b>P</b>	Save your configuration into permanent memory (flash rom)	switch#write memory
<b>system name</b> [System Name]	<b>G</b>	Configure system name	switch(config)#system name xxx
<b>system location</b> [System Location]	<b>G</b>	Set switch system location string	switch(config)#system location xxx
<b>system description</b> [System Description]	<b>G</b>	Set switch system description string	switch(config)#system description xxx
<b>system contact</b> [System Contact]	<b>G</b>	Set switch system contact window string	switch(config)#system contact xxx
<b>show system-info</b>	<b>E</b>	Show system information	switch>show system-info
<b>ip address</b> [Ip-address] [Subnet-mask] [Gateway]	<b>G</b>	Configure the IP address of switch	switch(config)#ip address 192.168.1.1 255.255.255.0 192.168.1.254
<b>ip dhcp</b>	<b>G</b>	Enable DHCP client	switch(config)#ip dhcp

		function of switch	
<b>show ip</b>	<b>P</b>	Show IP information of switch	switch#show ip
<b>no ip dhcp</b>	<b>G</b>	Disable DHCP client function of switch	switch(config)#no ip dhcp
<b>reload</b>	<b>G</b>	Halt and perform a cold restart	switch(config)#reload
<b>default</b>	<b>G</b>	Restore to default	Switch(config)#default
<b>admin username</b> [Username]	<b>G</b>	Changes a login username. (maximum 10 words)	switch(config)#admin username xxxxxx
<b>admin password</b> [Password]	<b>G</b>	Specifies a password (maximum 10 words)	switch(config)#admin password xxxxxx
<b>show admin</b>	<b>P</b>	Show administrator information	switch#show admin
<b>dhcpserver enable</b>	<b>G</b>	Enable DHCP Server	switch(config)#dhcpserver enable
<b>dhcpserver lowip</b> [Low IP]	<b>G</b>	Configure low IP address for IP pool	switch(config)# dhcpserver lowip 192.168.1.1
<b>dhcpserver highip</b> [High IP]	<b>G</b>	Configure high IP address for IP pool	switch(config)# dhcpserver highip 192.168.1.50
<b>dhcpserver subnetmask</b> [Subnet mask]	<b>G</b>	Configure subnet mask for DHCP clients	switch(config)#dhcpserver subnetmask 255.255.255.0
<b>dhcpserver gateway</b> [Gateway]	<b>G</b>	Configure gateway for DHCP clients	switch(config)#dhcpserver gateway 192.168.1.254
<b>dhcpserver dnsip</b> [DNS IP]	<b>G</b>	Configure DNS IP for DHCP clients	switch(config)# dhcpserver dnsip 192.168.1.1
<b>dhcpserver leasetime</b> [Hours]	<b>G</b>	Configure lease time (in hour)	switch(config)#dhcpserver leasetime 1
<b>dhcpserver ipbinding</b> [IP address]	<b>I</b>	Set static IP for DHCP clients by port	switch(config)#interface fastEthernet 2 switch(config-if)#dhcpserver ipbinding 192.168.1.1
<b>show dhcpserver configuration</b>	<b>P</b>	Show configuration of DHCP server	switch#show dhcpserver configuration
<b>show dhcpserver clients</b>	<b>P</b>	Show client entries of DHCP server	switch#show dhcpserver clinets

<b>show dhcpserver ip-binding</b>	<b>P</b>	Show IP-Binding information of DHCP server	switch#show dhcpserver ip-binding
<b>no dhcpserver</b>	<b>G</b>	Disable DHCP server function	switch(config)#no dhcpserver
<b>security enable</b>	<b>G</b>	Enable IP security function	switch(config)#security enable
<b>security http</b>	<b>G</b>	Enable IP security of HTTP server	switch(config)#security http
<b>security telnet</b>	<b>G</b>	Enable IP security of telnet server	switch(config)#security telnet
<b>security ip [Index(1..10)] [IP Address]</b>	<b>G</b>	Set the IP security list	switch(config)#security ip 1 192.168.1.55
<b>show security</b>	<b>P</b>	Show the information of IP security	switch#show security
<b>no security</b>	<b>G</b>	Disable IP security function	switch(config)#no security
<b>no security http</b>	<b>G</b>	Disable IP security of HTTP server	switch(config)#no security http
<b>no security telnet</b>	<b>G</b>	Disable IP security of telnet server	switch(config)#no security telnet

## 6.2 Commands Set List—Port Commands Set

IGS-3032GCCommands	Level	Description	Example
<b>interface fastEthernet [Portid]</b>	<b>G</b>	Choose the port for modification.	switch(config)#interface fastEthernet 2
<b>duplex [full   half]</b>	<b>I</b>	Use the duplex configuration command to specify the duplex mode of operation for Fast Ethernet.	switch(config)#interface fastEthernet 2 switch(config-if)#duplex full
<b>speed [10 100 1000 auto]</b>	<b>I</b>	Use the speed configuration command to specify	switch(config)#interface fastEthernet 2 switch(config-if)#speed 100

		the speed mode of operation for Fast Ethernet., the speed can't be set to 1000 if the port isn't a giga port..	
<b>flowcontrol mode</b> [Symmetric Asymmetric]	I	Use the flowcontrol configuration command on Ethernet ports to control traffic rates during congestion.	switch(config)#interface fastEthernet 2 switch(config-if)#flowcontrol mode Asymmetric
<b>no flowcontrol</b>	I	Disable flow control of interface	switch(config-if)#no flowcontrol
<b>security enable</b>	I	Enable security of interface	switch(config)#interface fastEthernet 2 switch(config-if)#security enable
<b>no security</b>	I	Disable security of interface	switch(config)#interface fastEthernet 2 switch(config-if)#no security
<b>bandwidth type all</b>	I	Set interface ingress limit frame type to "accept all frame"	switch(config)#interface fastEthernet 2 switch(config-if)#bandwidth type all
<b>bandwidth type broadcast-multicast-flooded-unicast</b>	I	Set interface ingress limit frame type to "accept broadcast, multicast, and flooded unicast frame"	switch(config)#interface fastEthernet 2 switch(config-if)#bandwidth type broadcast-multicast-flooded-unicast
<b>bandwidth type broadcast-multicast</b>	I	Set interface ingress limit frame type to "accept broadcast and multicast frame"	switch(config)#interface fastEthernet 2 switch(config-if)#bandwidth type broadcast-multicast
<b>bandwidth type broadcast-only</b>	I	Set interface ingress limit frame type to "only accept broadcast frame"	switch(config)#interface fastEthernet 2 switch(config-if)#bandwidth type broadcast-only

<p><b>bandwidth in</b> [Value]</p>	<p>I</p>	<p>Set interface input bandwidth. Rate Range is from 100 kbps to 102400 kbps or to 256000 kbps for giga ports, and zero means no limit.</p>	<p>switch(config)#interface fastEthernet 2 switch(config-if)#bandwidth in 100</p>
<p><b>bandwidth out</b> [Value]</p>	<p>I</p>	<p>Set interface output bandwidth. Rate Range is from 100 kbps to 102400 kbps or to 256000 kbps for giga ports, and zero means no limit.</p>	<p>switch(config)#interface fastEthernet 2 switch(config-if)#bandwidth out 100</p>
<p><b>show bandwidth</b></p>	<p>I</p>	<p>Show interfaces bandwidth control</p>	<p>switch(config)#interface fastEthernet 2 switch(config-if)#show bandwidth</p>
<p><b>state</b> [Enable   Disable]</p>	<p>I</p>	<p>Use the state interface configuration command to specify the state mode of operation for Ethernet ports. Use the disable form of this command to disable the port.</p>	<p>switch(config)#interface fastEthernet 2 switch(config-if)#state Disable</p>
<p><b>show interface configuration</b></p>	<p>I</p>	<p>show interface configuration status</p>	<p>switch(config)#interface fastEthernet 2 switch(config-if)#show interface configuration</p>
<p><b>show interface status</b></p>	<p>I</p>	<p>show interface actual status</p>	<p>switch(config)#interface fastEthernet 2 switch(config-if)#show interface</p>

			status
<b>show interface accounting</b>	<b>I</b>	show interface statistic counter	switch(config)#interface fastEthernet 2 switch(config-if)#show interface accounting
<b>no accounting</b>	<b>I</b>	Clear interface accounting information	switch(config)#interface fastEthernet 2 switch(config-if)#no accounting

### 6.3 Commands Set List—Trunk command set

IGS-3032GCCommands	Level	Description	Example
<b>aggregator priority</b> [1to65535]	<b>G</b>	Set port group system priority	switch(config)#aggregator priority 22
<b>aggregator activityport</b> [Port Numbers]	<b>G</b>	Set activity port	switch(config)#aggregator activityport 2
<b>aggregator group</b> [GroupID] [Port-list] <b>lacp</b> <b>workp</b> [Workport]	<b>G</b>	Assign a trunk group with LACP active. [GroupID] : 1to3 [Port-list]: Member port list, This parameter could be a port range(ex. 1-4) or a port list separate by a comma(ex. 2, 3, 6) [Workport]: The amount of work ports, this value could not be less than zero or be large than the amount of member ports.	switch(config)#aggregator group 1 1-4 lacp workp 2 or switch(config)#aggregator group 2 1,4,3 lacp workp 3
<b>aggregator group</b> [GroupID] [Port-list] <b>nolacp</b>	<b>G</b>	Assign a static trunk group. [GroupID] : 1to3 [Port-list]: Member port list, This parameter could be a port	switch(config)#aggregator group 1 2-4 nolacp or switch(config)#aggregator group 1 3,1,2 nolacp

		range(ex.1-4) or a port list separate by a comma(ex.2, 3, 6)	
<b>show aggregator</b>	<b>P</b>	Show the information of trunk group	switch#show aggregator
<b>no aggregator lacp</b> [GroupID]	<b>G</b>	Disable the LACP function of trunk group	switch(config)#no aggregator lacp 1
<b>no aggregator group</b> [GroupID]	<b>G</b>	Remove a trunk group	switch(config)#no aggregator group 2

### 6.4 Commands Set List—VLAN command set

IGS-3032GCCommands	Level	Description	Example
<b>vlan database</b>	<b>P</b>	Enter VLAN configure mode	switch#vlan database
<b>vlan</b> [8021q   gvrp]	<b>V</b>	To set switch VLAN mode.	switch(vlan)# vlanmode 802.1q or switch(vlan)# vlanmode gvrp
<b>no vlan</b> [VID]	<b>V</b>	Disable vlan group(by VID)	switch(vlan)#no vlan 2
<b>no gvrp</b>	<b>V</b>	Disable GVRP	switch(vlan)#no gvrp
<b>IEEE 802.1Q VLAN</b>			
<b>vlan 8021q port</b> [PortNumber] <b>access-link untag</b> [UntaggedVID]	<b>V</b>	Assign a access link for VLAN by port, if the port belong to a trunk group, this command can't be applied.	switch(vlan)#vlan 802.1q port 3 access-link untag 33
<b>vlan 8021q port</b> [PortNumber] <b>trunk-link tag</b> [TaggedVID List]	<b>V</b>	Assign a trunk link for VLAN by port, if the port belong to a trunk group, this command can't be applied.	switch(vlan)#vlan 8021q port 3 trunk-link tag 2,3,6,99 or switch(vlan)#vlan 8021q port 3 trunk-link tag 3-20
<b>vlan 8021q port</b> [PortNumber] <b>hybrid-link untag</b> [UntaggedVID] <b>tag</b>	<b>V</b>	Assign a hybrid link for VLAN by port, if the port belong to a trunk group, this command can't be applied.	switch(vlan)# vlan 8021q port 3 hybrid-link untag 4 tag 3,6,8 or switch(vlan)# vlan 8021q port 3 hybrid-link untag 5 tag 6-8



[TaggedVID List]			
<b>vlan 8021q aggregator</b> [TrunkID] <b>access-link untag</b> [UntaggedVID]	<b>V</b>	Assign a access link for VLAN by trunk group	switch(vlan)#vlan 8021q aggregator 3 access-link untag 33
<b>vlan 8021q aggregator</b> [TrunkID] <b>trunk-link tag</b> [TaggedVID List]	<b>V</b>	Assign a trunk link for VLAN by trunk group	switch(vlan)#vlan 8021q aggregator 3 trunk-link tag 2,3,6,99 or switch(vlan)#vlan 8021q aggregator 3 trunk-link tag 3-20
<b>vlan 8021q aggregator</b> [PortNumber] <b>hybrid-link untag tag</b> [UntaggedVID] [TaggedVID List]	<b>V</b>	Assign a hybrid link for VLAN by trunk group	switch(vlan)# vlan 8021q aggregator 3 hybrid-link untag 4 tag 3,6,8 or switch(vlan)# vlan 8021q aggregator 3 hybrid-link untag 5 tag 6-8
<b>show vlan [VID]</b> or <b>show vlan</b>	<b>V</b>	Show VLAN information	switch(vlan)#show vlan 23

### 6.5 Commands Set List—Spanning Tree command set

IGS-3032GCCommands	Level	Description	Example
<b>spanning-tree enable</b>	<b>G</b>	Enable spanning tree	switch(config)#spanning-tree enable
<b>spanning-tree priority</b> [0to61440]	<b>G</b>	Configure spanning tree priority parameter	switch(config)#spanning-tree priority 32767
<b>spanning-tree max-age</b> [seconds]	<b>G</b>	Use the spanning-tree max-age global configuration command to change the interval between messages the spanning tree receives from the root switch. If a switch	switch(config)# spanning-tree max-age 15

		does not receive a bridge protocol data unit (BPDU) message from the root switch within this interval, it recomputed the Spanning Tree Protocol (STP) topology.	
<b>spanning-tree hello-time</b> [seconds]	<b>G</b>	Use the spanning-tree hello-time global configuration command to specify the interval between hello bridge protocol data units (BPDUs).	switch(config)#spanning-tree hello-time 3
<b>spanning-tree forward-time</b> [seconds]	<b>G</b>	Use the spanning-tree forward-time global configuration command to set the forwarding-time for the specified spanning-tree instances. The forwarding time determines how long each of the listening and learning states last before the port begins forwarding.	switch(config)# spanning-tree forward-time 20
<b>stp-path-cost</b> [1to200000000]	<b>I</b>	Use the spanning-tree cost interface configuration command to set the path cost for Spanning	switch(config)#interface fastEthernet 2 switch(config-if)#stp-path-cost 20

		Tree Protocol (STP) calculations. In the event of a loop, spanning tree considers the path cost when selecting an interface to place into the forwarding state.	
<b>stp-path-priority</b> <b>[Port Priority]</b>	<b>I</b>	Use the spanning-tree port-priority interface configuration command to configure a port priority that is used when two switches tie for position as the root switch.	switch(config)#interface fastEthernet 2 switch(config-if)# stp-path-priority 127
<b>stp-admin-p2p</b> <b>[Auto True False]</b>	<b>I</b>	Admin P2P of STP priority on this interface.	switch(config)#interface fastEthernet 2 switch(config-if)# stp-admin-p2p Auto
<b>stp-admin-edge</b> <b>[True False]</b>	<b>I</b>	Admin Edge of STP priority on this interface.	switch(config)#interface fastEthernet 2 switch(config-if)# stp-admin-edge True
<b>stp-admin-non-stp</b> <b>[True False]</b>	<b>I</b>	Admin NonSTP of STP priority on this interface.	switch(config)#interface fastEthernet 2 switch(config-if)# stp-admin-non-stp False
<b>Show spanning-tree</b>	<b>E</b>	Display a summary of the spanning-tree states.	switch>show spanning-tree
<b>no spanning-tree</b>	<b>G</b>	Disable spanning-tree.	switch(config)#no spanning-tree

## 6.6 Commands Set List—QoS command set

IGS-3032GCCommands	Level	Description	Example
<b>qos policy</b> [weighted-fair strict]	<b>G</b>	Select QOS policy scheduling	switch(config)#qos policy weighted-fair
<b>qos prioritytype</b> [port-based cos-only tos-only cos-first tos-first]	<b>G</b>	Setting of QOS priority type	switch(config)#qos prioritytype
<b>qos priority portbased</b> [Port] [lowest low middle high]	<b>G</b>	Configure Port-based Priority	switch(config)#qos priority portbased 1 low
<b>qos priority cos</b> [Priority][lowest low middle high]	<b>G</b>	Configure COS Priority	switch(config)#qos priority cos 22 middle
<b>qos priority tos</b> [Priority][lowest low middle high]	<b>G</b>	Configure TOS Priority	switch(config)#qos priority tos 3 high
<b>show qos</b>	<b>P</b>	Display the information of QoS configuration	switch>show qos
<b>no qos</b>	<b>G</b>	Disable QoS function	switch(config)#no qos

## 6.7 Commands Set List—IGMP command set

IGS-3032GCCommands	Level	Description	Example
<b>igmp enable</b>	<b>G</b>	Enable IGMP snooping function	switch(config)#igmp enable
<b>igmp-query auto</b>	<b>G</b>	Set IGMP query to auto mode	switch(config)#igmp-query auto
<b>igmp-query force</b>	<b>G</b>	Set IGMP query to force mode	switch(config)#igmp-query force
<b>show igmp configuration</b>	<b>P</b>	Displays the details of an IGMP configuration.	switch#show igmp configuration
<b>show igmp multi</b>	<b>P</b>	Displays the details of an IGMP snooping entries.	switch#show igmp multi
<b>no igmp</b>	<b>G</b>	Disable IGMP	switch(config)#no igmp

		snooping function	
<b>no igmp-query</b>	<b>G</b>	Disable IGMP query	switch#no igmp-query

## 6.8 Commands Set List—MAC/Filter Table command set

IGS-3032GCCommands	Level	Description	Example
<b>mac-address-table static hwaddr</b> [MAC]	<b>I</b>	Configure MAC address table of interface (static).	switch(config)#interface fastEthernet 2 switch(config-if)#mac-address-table static hwaddr 000012345678
<b>mac-address-table filter hwaddr</b> [MAC]	<b>G</b>	Configure MAC address table(filter)	switch(config)#mac-address-table filter hwaddr 000012348678
<b>show mac-address-table</b>	<b>P</b>	Show all MAC address table	switch#show mac-address-table
<b>show mac-address-table static</b>	<b>P</b>	Show static MAC address table	switch#show mac-address-table static
<b>show mac-address-table filter</b>	<b>P</b>	Show filter MAC address table.	switch#show mac-address-table filter
<b>no mac-address-table static hwaddr</b> [MAC]	<b>I</b>	Remove an entry of MAC address table of interface (static)	switch(config)#interface fastEthernet 2 switch(config-if)#no mac-address-table static hwaddr 000012345678
<b>no mac-address-table filter hwaddr</b> [MAC]	<b>G</b>	Remove an entry of MAC address table (filter)	switch(config)#no mac-address-table filter hwaddr 000012348678
<b>no mac-address-table</b>	<b>G</b>	Remove dynamic entry of MAC address table	switch(config)#no mac-address-table

## 6.9 Commands Set List—SNMP command set

IGS-3032GCCommands	Level	Description	Example
<b>snmp agent-mode</b> [v1v2c   v3]	<b>G</b>	Select the agent mode of SNMP	switch(config)#snmp agent-mode v1v2c
<b>snmp-server host</b> [IP address]	<b>G</b>	Configure SNMP server host	switch(config)#snmp-server host 192.168.10.50 community public

<b>community</b> [Community-string] <b>trap-version</b> [v1 v2c]		information and community string	trap-version v1 (remove) Switch(config)# no snmp-server host 192.168.10.50
<b>snmp</b> <b>community-strings</b> [Community-string] <b>right</b> [RO RW]	<b>G</b>	Configure the community string right	switch(config)#snmp community-strings public right RO or switch(config)#snmp community-strings public right RW
<b>snmp snmpv3-user</b> [User Name] <b>password</b> [Authentication Password] [Privacy Password]	<b>G</b>	Configure the userprofile for SNMPV3 agent. Privacy password could be empty.	switch(config)#snmp snmpv3-user test01 password AuthPW PrivPW
<b>show snmp</b>	<b>P</b>	Show SNMP configuration	switch#show snmp
<b>show snmp-server</b>	<b>P</b>	Show specified trap server information	switch#show snmp-server
<b>no snmp</b> <b>community-strings</b> [Community]	<b>G</b>	Remove the specified community.	switch(config)#no snmp community-strings public
<b>no snmp snmpv3-user</b> [User Name] <b>password</b> [Authentication Password] [Privacy Password]	<b>G</b>	Remove specified user of SNMPv3 agent. Privacy password could be empty.	switch(config)# no snmp snmpv3-user test01 password AuthPW PrivPW
<b>no snmp-server host</b> [Host-address]	<b>G</b>	Remove the SNMP server host.	switch(config)#no snmp-server 192.168.10.50

### 6.10 Commands Set List—Port Mirroring command set

IGS-3032GCCommands	Level	Description	Example
<b>monitor rx</b>	<b>G</b>	Set RX destination port of monitor	switch(config)#monitor rx

		function	
<b>monitor tx</b>	<b>G</b>	Set TX destination port of monitor function	switch(config)#monitor tx
<b>show monitor</b>	<b>P</b>	Show port monitor information	switch#show monitor
<b>monitor</b> [RX TX Both]	<b>I</b>	Configure source port of monitor function	switch(config)#interface fastEthernet 2 switch(config-if)#monitor RX
<b>show monitor</b>	<b>I</b>	Show port monitor information	switch(config)#interface fastEthernet 2 switch(config-if)#show monitor
<b>no monitor</b>	<b>I</b>	Disable source port of monitor function	switch(config)#interface fastEthernet 2 switch(config-if)#no monitor

### 6.11 Commands Set List—802.1x command set

IGS-3032GCCommands	Level	Description	Example
<b>8021x enable</b>	<b>G</b>	Use the 802.1x global configuration command to enable 802.1x protocols.	switch(config)# 8021x enable
<b>8021x system radiusip</b> [IP address]	<b>G</b>	Use the 802.1x system radius IP global configuration command to change the radius server IP.	switch(config)# 8021x system radiusip 192.168.1.1
<b>8021x system serverport</b> [port ID]	<b>G</b>	Use the 802.1x system server port global configuration command to change the radius server port	switch(config)# 8021x system serverport 1815
<b>8021x system accountport</b> [port ID]	<b>G</b>	Use the 802.1x system account port global configuration command to change	switch(config)# 8021x system accountport 1816

		the accounting port	
<b>8021x system sharekey</b> [ID]	<b>G</b>	Use the 802.1x system share key global configuration command to change the shared key value.	switch(config)# 8021x system sharekey 123456
<b>8021x system nasid</b> [words]	<b>G</b>	Use the 802.1x system nasid global configuration command to change the NAS ID	switch(config)# 8021x system nasid test1
<b>8021x misc quietperiod</b> [sec.]	<b>G</b>	Use the 802.1x misc quiet period global configuration command to specify the quiet period value of the switch.	switch(config)# 8021x misc quietperiod 10
<b>8021x misc txperiod</b> [sec.]	<b>G</b>	Use the 802.1x misc TX period global configuration command to set the TX period.	switch(config)# 8021x misc txperiod 5
<b>8021x misc supportimeout</b> [sec.]	<b>G</b>	Use the 802.1x misc supp timeout global configuration command to set the supplicant timeout.	switch(config)# 8021x misc supportimeout 20
<b>8021x misc servertimeout</b> [sec.]	<b>G</b>	Use the 802.1x misc server timeout global configuration command to set the server timeout.	switch(config)#8021x misc servertimeout 20
<b>8021x misc maxrequest</b> [number]	<b>G</b>	Use the 802.1x misc max request global configuration	switch(config)# 8021x misc maxrequest 3



		command to set the MAX requests.	
<b>8021x misc reauthperiod</b> [sec.]	<b>G</b>	Use the 802.1x misc reauth period global configuration command to set the reauth period.	switch(config)# 8021x misc reauthperiod 3000
<b>8021x portstate</b> [disable   reject   accept   authorize]	<b>I</b>	Use the 802.1x port state interface configuration command to set the state of the selected port.	switch(config)#interface fastethernet 3 switch(config-if)#8021x portstate accept
<b>show 8021x</b>	<b>E</b>	Display a summary of the 802.1x properties and also the port sates.	switch>show 8021x
<b>no 8021x</b>	<b>G</b>	Disable 802.1x function	switch(config)#no 8021x

### 6.12 Commands Set List—TFTP command set

IGS-3032GCCommands	Level	Description	Defaults Example
<b>backup flash:backup_cfg</b>	<b>G</b>	Save configuration to TFTP and need to specify the IP of TFTP server and the file name of image.	switch(config)#backup flash:backup_cfg
<b>restore flash:restore_cfg</b>	<b>G</b>	Get configuration from TFTP server and need to specify the IP of TFTP server and the file name of image.	switch(config)#restore flash:restore_cfg

<b>upgrade</b> <b>flash:upgrade_fw</b>	<b>G</b>	Upgrade firmware by TFTP and need to specify the IP of TFTP server and the file name of image.	switch(config)#upgrade lash:upgrade_fw
---	----------	--	---

### 6.13 Commands Set List—SYSLOG, SMTP, EVENT command set

IGS-3032GCCommands	Level	Description	Example
<b>systemlog ip</b> [IP address]	<b>G</b>	Set System log server IP address.	switch(config)# systemlog ip 192.168.1.100
<b>systemlog mode</b> [client server both]	<b>G</b>	Specified the log mode	switch(config)# systemlog mode both
<b>show systemlog</b>	<b>E</b>	Display system log.	Switch>show systemlog
<b>show systemlog</b>	<b>P</b>	Show system log client & server information	switch#show systemlog
<b>no systemlog</b>	<b>G</b>	Disable systemlog function	switch(config)#no systemlog
<b>smtp enable</b>	<b>G</b>	Enable SMTP function	switch(config)#smtp enable
<b>smtp serverip</b> [IP address]	<b>G</b>	Configure SMTP server IP	switch(config)#smtp serverip 192.168.1.5
<b>smtp authentication</b>	<b>G</b>	Enable SMTP authentication	switch(config)#smtp authentication
<b>smtp account</b> [account]	<b>G</b>	Configure authentication account	switch(config)#smtp account User
<b>smtp password</b> [password]	<b>G</b>	Configure authentication password	switch(config)#smtp password
<b>smtp rcptemail</b> [Index] [Email address]	<b>G</b>	Configure Rcpt e-mail Address	switch(config)#smtp rcptemail 1 <a href="mailto:Alert@test.com">Alert@test.com</a>
<b>show smtp</b>	<b>P</b>	Show the information of SMTP	switch#show smtp
<b>no smtp</b>	<b>G</b>	Disable SMTP function	switch(config)#no smtp

<b>event device-cold-start</b> [Systemlog SMTP Both]	<b>G</b>	Set cold start event type	switch(config)#event device-cold-start both
<b>event authentication-failure</b> [Systemlog SMTP Both]	<b>G</b>	Set Authentication failure event type	switch(config)#event authentication-failure both
<b>event O-Ring-topology-change</b> [Systemlog SMTP Both]	<b>G</b>	Set s ring topology changed event type	switch(config)#event ring-topology-change both
<b>event systemlog</b> [Link-UP Link-Down Both]	<b>I</b>	Set port event for system log	switch(config)#interface fastethernet 3 switch(config-if)#event systemlog both
<b>event smtp</b> [Link-UP Link-Down Both]	<b>I</b>	Set port event for SMTP	switch(config)#interface fastethernet 3 switch(config-if)#event smtp both
<b>show event</b>	<b>P</b>	Show event selection	switch#show event
<b>no event device-cold-start</b>	<b>G</b>	Disable cold start event type	switch(config)#no event device-cold-start
<b>no event authentication-failure</b>	<b>G</b>	Disable Authentication failure event typ	switch(config)#no event authentication-failure
<b>no event O-Ring-topology-change</b>	<b>G</b>	Disable O-Ring topology changed event type	switch(config)#no event ring-topology-change
<b>no event systemlog</b>	<b>I</b>	Disable port event for system log	switch(config)#interface fastethernet 3 switch(config-if)#no event systemlog
<b>no event smtp</b>	<b>I</b>	Disable port event for SMTP	switch(config)#interface fastethernet 3 switch(config-if)#no event smtp
<b>show systemlog</b>	<b>P</b>	Show system log client & server information	switch#show systemlog

## 6.14 Commands Set List—SNTP command set

IGS-3032GCCommands	Level	Description	Example
<b>sntp enable</b>	<b>G</b>	Enable SNTP function	switch(config)#sntp enable
<b>sntp daylight</b>	<b>G</b>	Enable daylight saving time, if SNTP function is inactive, this command can't be applied.	switch(config)#sntp daylight
<b>sntp daylight-period</b> [Start time] [End time]	<b>G</b>	Set period of daylight saving time, if SNTP function is inactive, this command can't be applied. Parameter format: [yyyymmdd-hh:mm]	switch(config)# sntp daylight-period 20060101-01:01 20060202-01-01
<b>sntp daylight-offset</b> [Minute]	<b>G</b>	Set offset of daylight saving time, if SNTP function is inactive, this command can't be applied.	switch(config)#sntp daylight-offset 3
<b>sntp ip</b> [IP]	<b>G</b>	Set SNTP server IP, if SNTP function is inactive, this command can't be applied.	switch(config)#sntp ip 192.169.1.1
<b>sntp timezone</b> [Timezone]	<b>G</b>	Set timezone index, use "show sntp timzezone" command to get more information of index number	switch(config)#sntp timezone 22
<b>show sntp</b>	<b>P</b>	Show SNTP information	switch#show sntp
<b>show sntp timezone</b>	<b>P</b>	Show index number of time zone list	switch#show sntp timezone

<b>no sntp</b>	<b>G</b>	Disable SNTP function	switch(config)#no sntp
<b>no sntp daylight</b>	<b>G</b>	Disable daylight saving time	switch(config)#no sntp daylight

### 6.15 Commands Set List—O-Ring command set

IGS-3032GCCommands	Level	Description	Example
<b>Ring enable</b>	<b>G</b>	Enable O-Ring	switch(config)# ring enable
<b>Ring master</b>	<b>G</b>	Enable ring master	switch(config)# ring master
<b>Ring couplering</b>	<b>G</b>	Enable couple ring	switch(config)# ring couplering
<b>Ring dualhoming</b>	<b>G</b>	Enable dual homing	switch(config)# ring dualhoming
<b>Ring ringport</b> [1st Ring Port] [2nd Ring Port]	<b>G</b>	Configure 1st/2nd Ring Port	switch(config)# ring ringport 7 8
<b>Ring couplingport</b> [Coupling Port]	<b>G</b>	Configure Coupling Port	switch(config)# ring couplingport 1
<b>Ring controlport</b> [Control Port]	<b>G</b>	Configure Control Port	switch(config)# ring controlport 2
<b>Ring homingport</b> [Dual Homing Port]	<b>G</b>	Configure Dual Homing Port	switch(config)# ring homingport 3
<b>show Ring</b>	<b>P</b>	Show the information of O-Ring	switch#show ring
<b>no Ring</b>	<b>G</b>	Disable O-Ring	switch(config)#no ring
<b>no Ring master</b>	<b>G</b>	Disable ring master	switch(config)# no ring master
<b>no Ring couplering</b>	<b>G</b>	Disable couple ring	switch(config)# no ring couplering
<b>no Ring dualhoming</b>	<b>G</b>	Disable dual homing	switch(config)# no ring dualhoming

# Technical Specifications

ORing Switch Model	IGS-3032GC
<b>Physical Ports</b>	
10/100/1000 Base-T Ports in RJ45 Auto MDI/MDIX	3
Gigabit Combo Port with 10/100/1000Base-T(X) and 100/1000Base-X SFP port	2
<b>Technology</b>	
Ethernet Standards	IEEE 802.3 for 10Base-T, IEEE 802.3u for 100Base-TX and 100Base-FX IEEE 802.3z for 1000Base-X IEEE 802.3ab for 1000Base-T(X), IEEE 802.3x for Flow control IEEE 802.3ad for LACP (Link Aggregation Control Protocol ) IEEE 802.1D for STP (Spanning Tree Protocol) IEEE 802.1p for COS (Class of Service) IEEE 802.1Q for VLAN Tagging IEEE 802.1w for RSTP (Rapid Spanning Tree Protocol) IEEE 802.1s for MSTP (Multiple Spanning Tree Protocol) IEEE 802.1x for Authentication IEEE 802.1AB for LLDP (Link Layer Discovery Protocol)
MAC Table	8192 MAC addresses
Priority Queues	4
Processing	Store-and-Forward
Switch Properties	Switching latency: 7 us Switching bandwidth: 10 Gbps Max. Number of Available VLANs: 4096 IGMP multicast groups: 1024 Port rate limiting: User Define
Security Features	Enable/disable ports, MAC based port security Port based network access control (802.1x) VLAN (802.1Q ) to segregate and secure network traffic Radius centralized password management SNMP v1/v2c/v3 encrypted authentication and access security
Software Features	STP/RSTP/MSTP (IEEE 802.1D/w/s) Redundant Ring (O-Ring) with recovery time less than 20ms over 250 units TOS/Diffserv supported Quality of Service (802.1p) for real-time traffic VLAN (802.1Q) with VLAN tagging and GVRP supported IGMP v2/v3 (IGMP Snooping support) for multicast filtering Port configuration, status, statistics, monitoring, security PTP Client (Precision Time Protocol) clock synchronization DHCP Server / Client support Port Trunk support MVR (Multicast VLAN Registration) support
Network Redundancy	MRP O-Ring Open-Ring STP RSTP MSTP
RS-232 Serial Console Port	RS-232 in RJ45 connector with console cable. 9600bps, 8, N, 1
<b>LED Indicators</b>	
Power Indicator	Green : Power LED x 3
R.M. Indicator	Green : Indicate system operated in O-Ring Master mode

Ring Indicator	Green : Indicate system operated in O-Ring mode
Fault Indicator	Amber : Indicate unexpected event occurred
10/100/1000Base-T(X) RJ45 Port Indicator	Green for port Link/Act. Amber for 100Mbps indicator
100/1000Base-X SFP Port Indicator	Green for port Link/Act.
<b>Fault contact</b>	
Relay	Relay output to carry capacity of 1A at 24VDC
<b>Power</b>	
Redundant Input Power	Triple DC inputs. +12~48VDC or -12~48VDC on 7-pin terminal block, 12 ~ 45VDC on power jack
Power Consumption (Typ.)	10 Watts
Overload Current Protection	Present
Reverse Polarity Protection	Present on terminal block
<b>Physical Characteristic</b>	
Enclosure	IP-30
Dimension (W x D x H)	54.2(W)x106.1(D)x145.4(H) mm (2.13x4.18x5.72 inch.)
Weight (g)	820g
<b>Environmental</b>	
Storage Temperature	-40 to 85°C (-40 to 185°F)
Operating Temperature	-40 to 70°C (-40 to 158°F)
Operating Humidity	5% to 95% Non-condensing
<b>Regulatory approvals</b>	
EMI	FCC Part 15, CISPR (EN55022) class A, EN50155 (EN50121-3-2, EN55011, EN50121-4)
EMS	EN61000-4-2 (ESD), EN61000-4-3 (RS), EN61000-4-4 (EFT), EN61000-4-5 (Surge), EN61000-4-6 (CS), EN61000-4-8, EN61000-4-9, EN61000-4-11
Shock	IEC60068-2-27, EN61373
Free Fall	IEC60068-2-32
Vibration	IEC60068-2-6, EN61373
Safety	EN60950-1
Warranty	5 years